

PARTS & ASSEMBLY SHEET







Fixture Name: Heartwood 8063-M1L BUS

This fixture assembled PO: _____ Date: _____

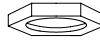
Notice: Please review the parts listing and check for all parts before assembling the fixture. If any parts are missing or damaged, please note on this sheet and contact the place of purchase to arrange for replacement parts.

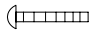
PARTS LIST

Company Name: _____ Co. Account #: _____
to be filled out by retailer

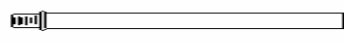
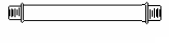
Canopy	1ea		Hex nut	2ea		Wire connectors	2ea	
Mounting bracket	1ea		Mounting screws	2ea		Socket rings	1ea	
Deco Nut	2ea		Fixture mounting screws	2ea		Socket washer	1ea	
12" Rod	2ea					6" Rod	1ea	
Part Needed	_____					Quantity	_____	
Part Needed	_____					Quantity	_____	
Reason why	(missing, scratched, broken glass, bent, bad finish)							
Comments	_____							

FIXTURE ASSEMBLY INSTRUCTIONS

Read and review installation instruction sheet, but do not install before assembling the fixture.

1. By measuring determine correct number of rods needed for proper hanging height. There are 2 optional 12" rods included.
2. To shorten the fixture trim the wires to the desired length plus at least 8~10 inches.
 - 2b. Slide the 6" rod plus the excess 12" rods off the wire.
 - 2c. Thread the 6" rod back onto the wire then thread the wire through the swivel connection into the canopy.
3. To lengthen the fixture pull all the wire out of the canopy.
 - 3b. Slide the 6" rod off the wire.
 - 3c. Thread the additional rods with the 6" rod last back onto the wire then thread the wire through the swivel connection into the canopy.

NOTE: INSTALL THE GLASS ASSEMBLY AFTER THE FIXTURE IS HUNG.

8063-M1L BUS

Fig 1

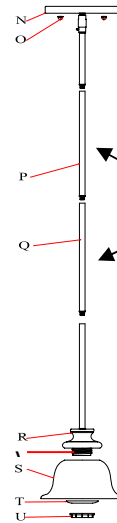

These two Rods may be removed or additional Rods may be added.
ROD-12 BUS

For Customer Service, contact the place of purchase to arrange for replacement parts.

PARTS & ASSEMBLY SHEET

Fixture Name: Heartwood 8063-M1L BUS

4. Pull the fixture's wire through the Rods until taut.
 5. Thread Rod (Q) into Frame (R) until tight.
 6. Thread Rod (P) into Rod (Q) until tight. repeat for any additional rods.
 7. Thread 6" Rod (W) into Rod (P) until tight.
 8. Loosen the Set screw (X) just until the rod will fit in the swivel coupler. Thread the 6" Rod (W) into the canopy (N) and tighten the Set screw(X)
- * You may now install the fixture.

9. Place the glass shade (S) over the threaded socket (V) and place the Socket Washer (T) onto the threaded socket (V) and secure both by threading the Socket ring (U) until tight.
10. Install the light bulb in accordance with the fixture's specifications.
(DO NOT EXCEED MAXIMUM WATTAGE RATING!)

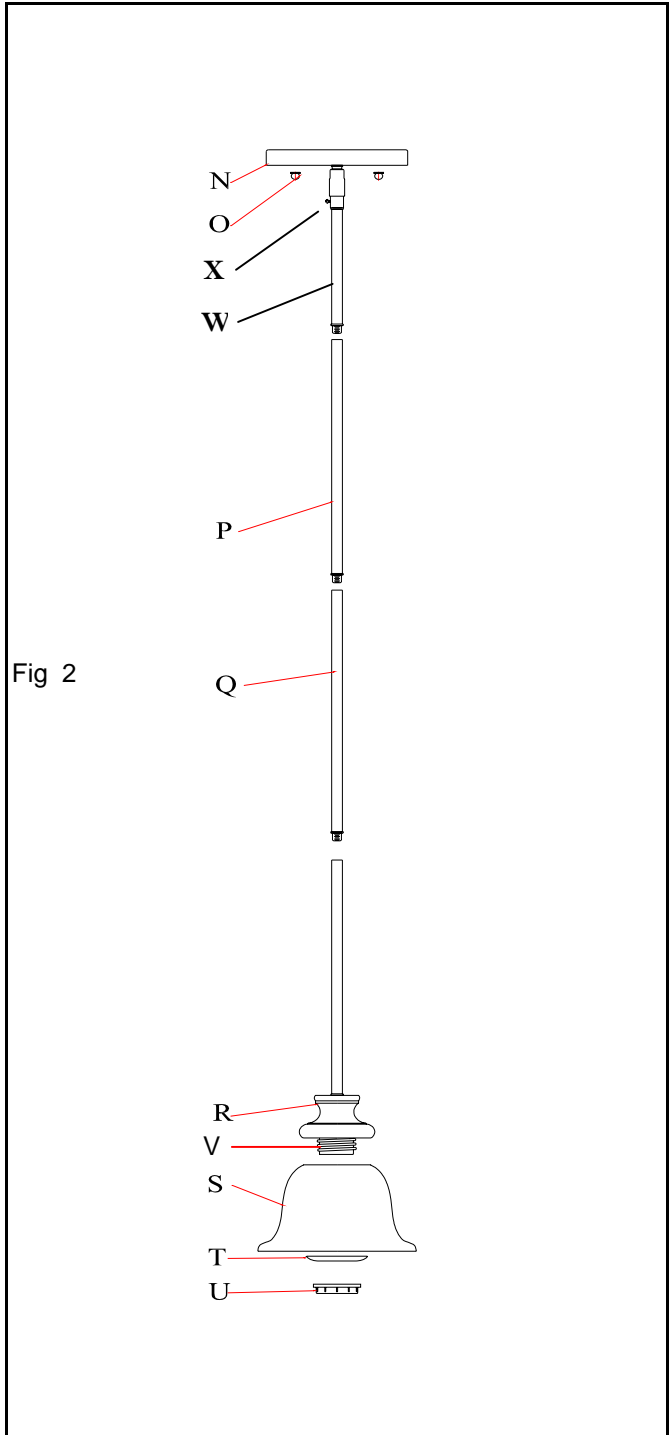

For Customer Service, contact the place of purchase to arrange for replacement parts.

WARNING ! SHUT OFF POWER AT FUSE OR CIRCUIT BREAKER.

HANGING THE FIXTURE as Semi flush (Fig. 1)

1. Carefully remove the new fixture from the carton and the yellow bag that holds all your parts. Check that all parts are included as shown in the illustration and parts list.
2. Shut off power at the circuit breaker and remove the old fixture from ceiling, including the old mounting strap.
3. The Mounting bracket (C) contains several pairs of threaded holes, find the pair of holes that match the hole spacing in your fixture Back Plate (N) and thread the two Mounting Screws (B) half way into the Mounting Strap (C) facing down, these will have their threaded ends protrude through the two holes in the fixture canopy(N).
4. Place the Mounting Strap (C) over the junction box
5. Attach the Mounting Strap (C) to the Junction Box using the two mounting screws (E). Tighten the screws (E) securely with screw driver.

CONNECTING THE WIRES (Fig 2)

6. Attach the power supply wires to the fixture lead wires by connecting BLACK to BLACK (or SMOOTH) and WHITE to WHITE (or RIBBED).
7. Attach the GROUND wire(GREEN or COPPER) from the Junction Box and the fixture Ground wire to the green Ground Screw (F) on the Mounting Bracket (C) or connect both wires together using the correct size of wire connectors. -
- NOTE: Twist the wires together in the same direction you twist the wire connector onto the wires.
8. Tuck these wire connections neatly into the Junction Box.

FINISHING THE INSALLATION (Fig.3)

9. Place the fixture's canopy over the Mounting Bracket (C) and over the Mounting Screws (B), adjust the fixture canopy (N) until the Mounting Screws (B) protrude out from the canopy (N) and secure the fixture against the ceiling by threading the decorative nuts(O) until tight.
10. Install the light bulbs and glass shade as per the fixture assembly sheet.

YOUR INSTALLATION IS NOW COMPLETE. RETURN POWER TO THE JUNCTION BOX AND TEST THE FIXTURE.

Fig. 1

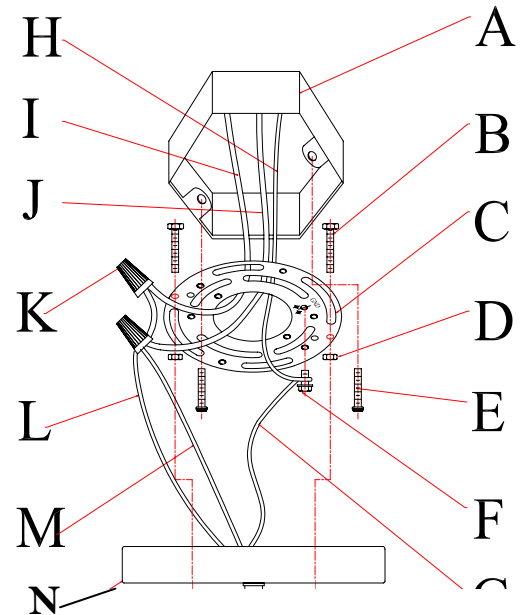

Fig. 2

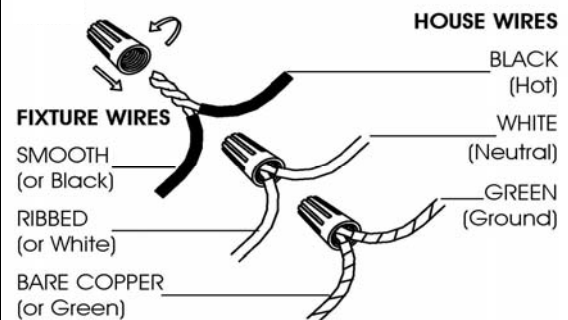

Fig. 3

