

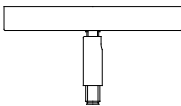

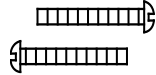
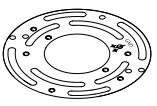
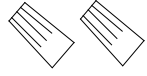

Fixture Name: Marco 6068-M1L GMT

This fixture assembled PO: \_\_\_\_\_ Date: \_\_\_\_\_

**Notice:** Please review the parts listing and check for all parts before assembling the fixture. If any parts are missing or damaged, please note on this sheet and contact the place of purchase to arrange for replacement parts.

<b>PARTS LIST</b>		Company Name: _____ Co. Account #: _____ to be filled out by retailer	
Canopy 1ea $\varnothing 5'' \times H3/4''$ 	Mounting screws 2ea 8#32-IP*1" 	Mounting strap 1ea $\varnothing 4'' \times H2mm$ 	
Wire connectors 3ea P3 Orange 	Mounting screws 2ea 5/32-IP*1-3/5" 	Hex nut 2ea 5/32-IP*H3mm 	
Rod 3ea $\varnothing 11.7'' \times H12''$ 	Rod 1ea $\varnothing 11.7'' \times H6''$ 	Deco nut 2ea 5/32-IP*H10mm 	
Part Needed _____	Quantity _____		
Part Needed _____	Quantity _____		
Reason why _____	(missing, scratched, broken glass, bent, bad finish)		
Comments _____			

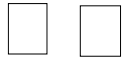
## FIXTURE ASSEMBLY INSTRUCTIONS

Read and review installation instruction sheet before assembling the fixture.

- By measuring determine correct number of rods needed for proper hanging height.  
\* This fixture includes 4 rods (6", 12", 12", 12")
- To shorten the fixture; slide the excess rods off the wires. To lengthen add additional rods. The 12" rods are optional.
- Pull the fixture's wires through the rods (G) until taut and thread the rods together. Then thread to the fixture coupler (H) at top of fixture and the swivel joint on Canopy. (F)
- Place the Glass Shade (J) over the Socket (I).
- Install the light bulb in accordance with the fixture's specification.

(DO NOT EXCEED THE MAXIMUM WATTAGE RATING!)

**NOTE: INSTALL THE GLASS ASSEMBLY AFTER THE FIXTURE IS HUNG.**

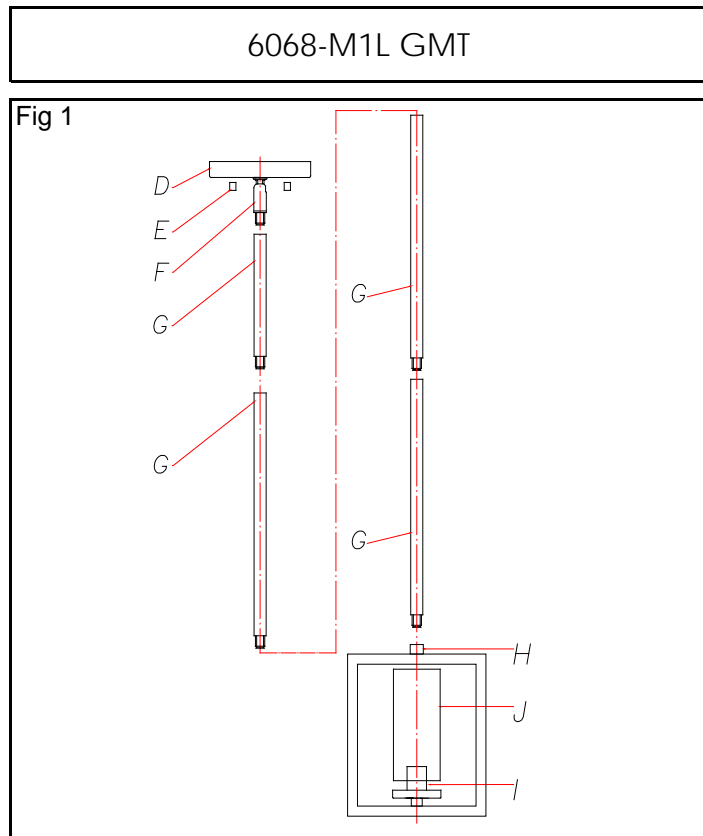

For Customer Service, contact the place of purchase to arrange for replacement parts.

Fixture Name: Marco 6068-M1L GMT

For Mini Pendant Light Fixture

## WARNING ! SHUT OFF POWER AT FUSE OR CIRCUIT BREAKER.

### HANGING THE FIXTURE as Pendant (Fig. 1)

1. Carefully remove the new fixture from the carton and the yellow bag that holds all your parts. Check that all parts are included as shown in the illustration and parts list.
2. Shut off power at the circuit breaker and remove the old fixture from ceiling, including the old mounting strap.
3. The Mounting bracket ( C ) contains several pairs of threaded holes, find the pair of holes that match the hole spacing in your fixture Back Plate (N) and thread the two Mounting Screws (B) half way into the Mounting Strap (C) facing down, these will have their threaded ends protrude through the two holes in the fixture canopy(N).
4. Place the Mounting Strap ( C ) over the junction box
5. Attach the Mounting Strap (C) to the Junction Box using the two mounting screws (E). Tighten the screws (E) securely with screw driver.

### CONNECTING THE WIRES (Fig. 2)

6. Attach the power supply wires to the fixture lead wires by connecting BLACK to BLACK (or SMOOTH) and WHITE to WHITE (or RIBBED).
  7. Attach the GROUND wire(GREEN or COPPER) from the Junction Box and the fixture Ground wire to the green Ground Screw on the Mounting Bracket (E) or connect both wires together using the correct size of wire connectors.
- NOTE: Twist the wires together in the same direction you twist the wire connector onto the wires.
8. Tuck these wire connections neatly into the Junction Box.

### FINISHING THE INSALLATION (Fig. 3)

9. Place the fixture's canopy over the Mounting bracket (C), adjust the canopy (N) until the Mounting Screws (B) protrude out from the canopy (N) and secure by threading the Decorative nuts (O) on until tight.
  10. Install the light bulbs and glass shade as per the fixture assembly sheet.
- YOUR INSTALLATION IS NOW COMPLETE.  
RETURN POWER TO THE JUNCTION BOX AND TEST THE FIXTURE.

