

WARNING! SHUT POWER OFF AT FUSE OR CIRCUIT BREAKER

HANGING THE FIXTURE (Fig.1)

- Carefully remove the new fixture from the carton and the yellow bag that holds all parts. Check that all parts are included as shown in the illustration and parts list.
- Shut off the power at the circuit breaker and remove old fixture from ceiling, including the old mounting strap.
- Thread Nipple(C) into Canopy Loop (F) until snug.
- Thread other end of the Nipple (C) with Canopy Loop attached into Mounting Strap (D).
- Place Lock Washer (B) over end of Nipple (C) protruding through Mounting Strap (D) and thread Hex Nuts (A) onto Nipple until tight.
- Take this mounting strap assembly and mount to ceiling junction box with junction box Screws (E). Tighten screw securely with screw driver.
- Unscrew the Canopy loop collar (H) from the Canopy loop. Take the canopy and pass over the Canopy loop. Approximately one half of the canopy loop exterior threads should be exposed. Adjust until desired height is reached. *the Canopy loop collar should fit snugly on the Canopy loop after the canopy is installed. Remove Canopy and Canopy loop collar.
- Assemble the fixture and have an assistant or secure support hold the weight of the fixture while you complete the wiring connections.
- Thread the fixture wires and ground wire of the assembled fixture through the canopy loop (F) and nipple(C) and chain (every three links) into the outlet box.

CONNECTING THE WIRES (Fig.2)

- Attach the power supply wires to the fixture lead wires by connecting BLACK to BLACK (or SMOOTH) and WHITE to WHITE (or RIBBED).
- Attach the GROUND wire (GREEN or COPPER) from the Junction Box and the fixture Ground wire to the green Ground Screw on the Mounting Bracket (B) or connect both wires together using the correct size of wire connectors.

NOTE: Twist the wires together in the same direction you twist the wire connector onto the wires.

- Tuck these wire connections neatly into the Junction Box.

FINISHING THE INSTALLATION (Fig.3)

- Raise Canopy (G) to the ceiling and secure in place by tightening the Canopy loop collar (H) into the Canopy Loop (F).
- Install the light bulbs and glass shade as per the fixture assembly sheet.

YOUR INSTALLATION IS NOW COMPLETE. TURN POWER ON AT TO THE JUNCTION BOX & TEST THE FIXTURE.

Fig.1

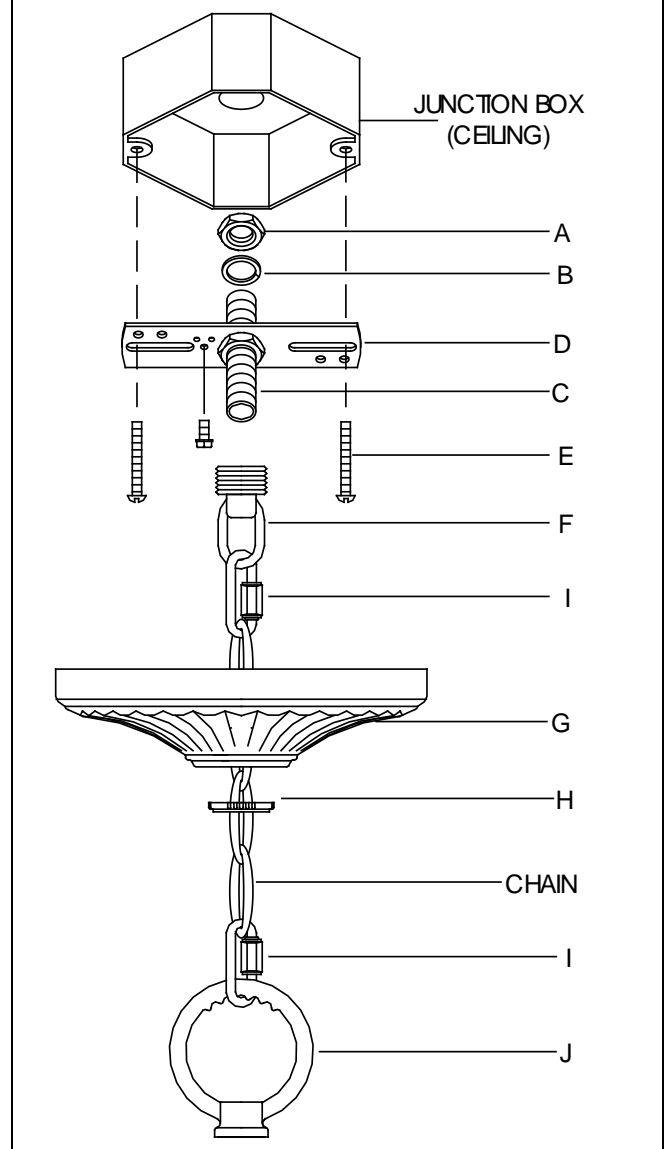
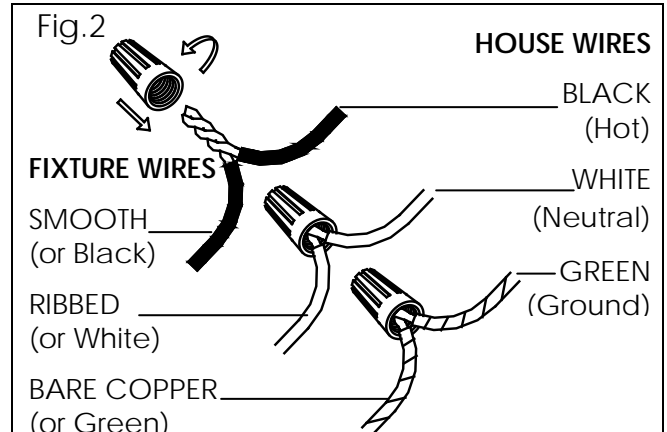

Fig.2



PARTS & ASSEMBLY SHEET









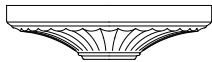

Fixture Name: BEAU JARDIN 5400-9 RG

This fixture assembled PO: _____ Date: _____

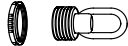
Notice: Please review the parts listing and check for all parts before assembling the fixture. If any parts are missing or damaged, please note on this sheet and contact the place of purchase to arrange for replacement parts.

PARTS LIST

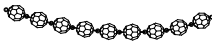
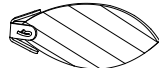
Company Name: _____ Co Account#: _____
below to be filled out by retailer

Canopy 1ea Φ 160*H42 mm		Hex Nut 2ea NPS-1/4-18		Wire Connectors 3ea Orange	
Chain 1ea Φ 3.8*6ft		Nipple 1ea NPS 1/4-18*65 mm		Canopy Loop 1ea NPS 1/4-18*H41 mm	
Link 2ea W20*H45 mm		Mounting Strap 1ea W103*T2.0 mm		Mounting Screws 2ea G8/32*H32 mm	
Bead String 6ea L720 mm		Crystal Leaf 71ea W27*H65 mm		Crystal Drop 1ea W58*H65 mm	

Part Needed _____ Quantity _____

Part Needed _____ Quantity _____

Reason why (missing, scratched, broken glass, bent, bad finish)

Comments _____

FIXTURE ASSEMBLY INSTRUCTIONS

Read and review installation instruction sheet before assembling the fixture

1. Screw Column (A) on the nipple until tight.
2. Screw Crystals (B) on the fixture body and Outside Shade Ring (C) "OSRING".
3. Hook the draping Bead String (D) and Crystal Drop (E) on the body
4. Place OSRING (C) and Glass Shade (F) over the socket and secure with Socket Ring (G).
5. Install the bulbs as specified.
(no bulbs included in the package)
(Do not exceed the maximum wattage rating!)

5400-9 RG

Fig.3

