

ROUGHING IN DIMENSIONS MAY VARY AND ARE SUBJECT TO CHANGE. NO RESPONSIBILITY IS ASSUMED FOR USE OF SUPERCEDED OR VOIDED DATA.



2100 South Clearwater Drive
Des Plaines, IL 60018
Phone: 800-566-2100
Fax: 847-803-5454
www.geberitnorthamerica.com

ROUGH-IN

FITTING NO.

150.183.00.1

BY: SID DATE: 05-07-08

SUBMITTED MODEL NO.

CHK: *[Signature]* REV:

FOR TECHNICAL ASSISTANCE
1-800-TEC-TRUE (1-800-832-8783)

SUBMITTED AS SHOWN

SUBMITTED AS NOTED

SEE ATTACHED FOR
SUBMITTED MODIFICATION

JOB NAME

ITEM NO.

NOTE:
'A' + 'B' NOT TO EXCEED 33"

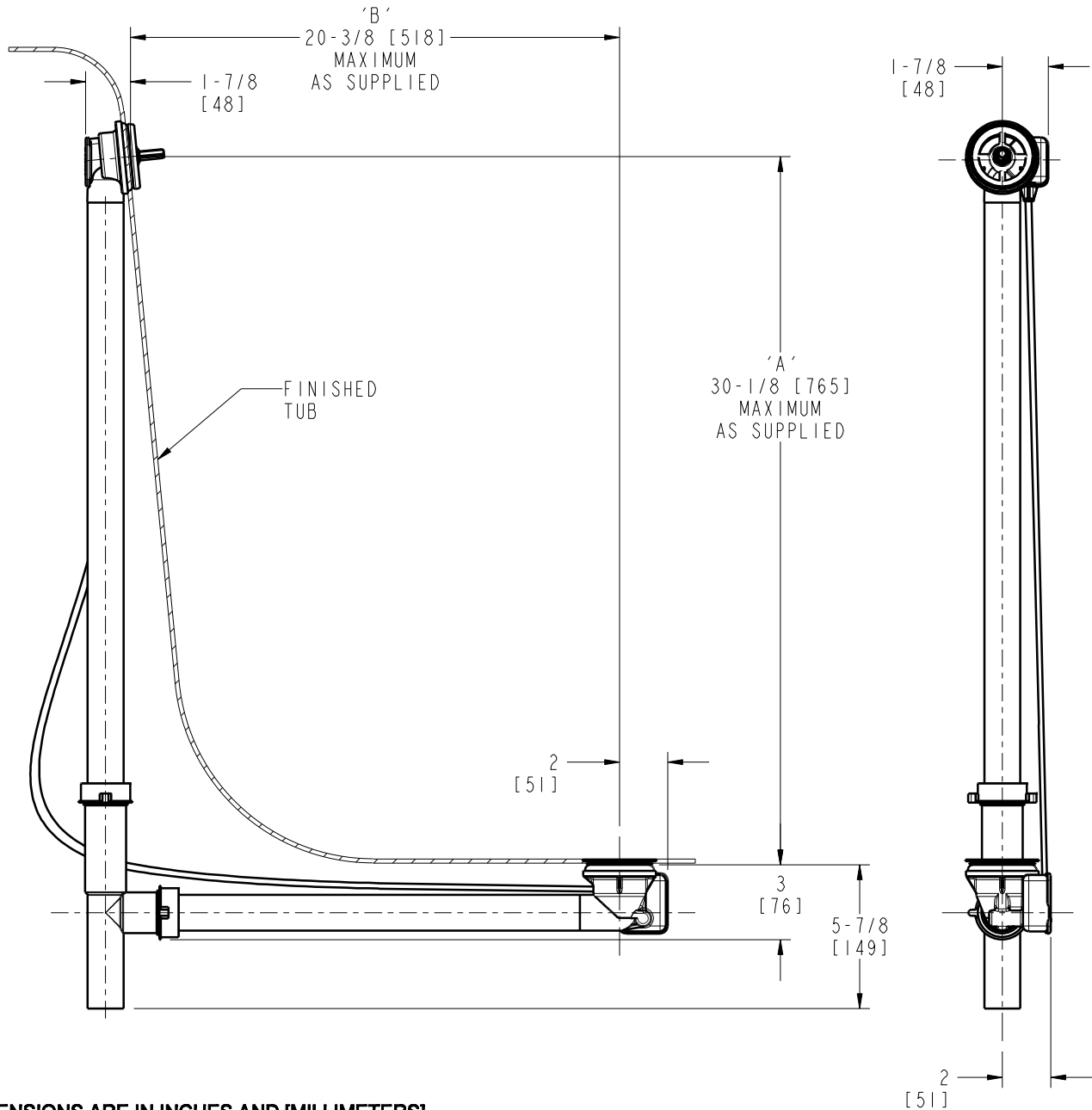

DIMENSIONS ARE IN INCHES AND [MILLIMETERS].

TECHNICAL DATA

- TURN CONTROL CABLE-OPERATED BATH WASTE & OVERFLOW
- ROUGH-IN BODY ONLY
- FITS MOST TUBS 30" DEEP
- 1-1/2" TUBULAR PP .08 WALL THICKNESS
- FITS TUB WALL THICKNESS 1/16" TO 5/16"
- 2" DIA. DRAIN HOLE OPENING
- 2" TO 2-1/2" DIA. OVERFLOW HOLE OPENING
- STAINLESS STEEL STRAINER
- 33" TEFLON® COATED STAINLESS STEEL CABLE
- INSTALLATION TOOL INCLUDED
- ASME A112.18.2/CSA B125.2 COMPLIANT