



# Direct Air Convection Built-In Electric Wall Oven

**Safety Information** ..... 2

**Warranty**..... 6

**Assistance / Accessories** ... 7

**Using The Oven**

Oven Controls..... 8

Special Features .....10

Oven Racks .....12

Cooking Modes .....14

Cookware.....15

Cooking Guide .....16

**Care and Cleaning**

Control Panel .....17

Oven Exterior .....17

Stainless Steel Surfaces .....17

Oven Interior.....17

Oven Racks .....18

Maintenance.....19

**Troubleshooting Tips** .....22

## Owner's Manual

- PT7050 - 30" Single Wall Oven
- PT9050 - 30" Single Wall Oven
- PT7550 - 30" Double Wall Oven
- PT9550 - 30" Double Wall Oven

*For a Spanish version of this manual, visit our Website at [GEAppliances.com](http://GEAppliances.com).*

*Para consultar una versión en español de este manual de instrucciones, visite nuestro sitio de internet [GEAppliances.com](http://GEAppliances.com).*

Write the model and serial numbers here:

Model # \_\_\_\_\_

Serial # \_\_\_\_\_

You can find them on a label on the side trim or on the front of the (lower) oven behind the oven door.



Printed on Recycled Paper

## IMPORTANT SAFETY INFORMATION. READ ALL INSTRUCTIONS BEFORE USING.

### **▲ WARNING**

Read all safety instructions before using the product. Failure to follow these instructions may result in fire, electrical shock, serious injury or death.

### STATE OF CALIFORNIA PROPOSITION 65 WARNING

The California Safe Drinking Water and Toxic Enforcement Act requires the Governor of California to publish a list of substances known to the state to cause cancer, birth defects or other reproductive harm, and requires businesses to warn customers of potential exposure to such substances.

### **▲ WARNING**

This product contains one or more chemical known to the State of California to cause cancer, birth defects or other reproductive harm.

Self-clean ovens can cause low-level exposure to some of these substances, including carbon monoxide, during the cleaning cycle. Exposure can be minimized by venting with an open window or using a ventilation fan or hood.

### **▲ WARNING**

### GENERAL SAFETY INSTRUCTIONS

- Use this appliance only for its intended purpose as described in this Owner's Manual.
- Be sure your appliance is properly installed and grounded by a qualified installer in accordance with the provided installation instructions.
- Do not attempt to repair or replace any part of your oven unless it is specifically recommended in this manual. All other servicing should be transferred to a qualified technician.
- Before performing any service, disconnect the power supply at the household distribution panel by removing the fuse or switching off the circuit breaker.
- Do not leave children alone—children should not be left alone or unattended in an area where an appliance is in use. They should never be allowed to climb, sit or stand on any part of the appliance.
- **▲ CAUTION** : Do not store items of interest to children in cabinets above an oven - children climbing on the oven to reach items could be seriously injured.
- Use only dry pot holders—moist or damp pot holders on hot surfaces may result in burns from steam. Do not let pot holders touch hot heating elements. Do not use a towel or other bulky cloth in place of pot holders.
- Never use your appliance for warming or heating the room.
- Do not touch the heating elements or the interior surface of the oven. These surfaces may be hot enough to burn even though they are dark in color. During and after use, do not touch, or let clothing or other flammable materials contact any interior area of the oven; allow sufficient time for cooling first. Other surfaces of the appliance may become hot enough to cause burns. Potentially hot surfaces include the oven vent opening, surfaces near the opening and crevices around the oven door.
- Do not heat unopened food containers. Pressure could build up and the container could burst, causing an injury.
- Do not use aluminum foil to line the oven bottom. Foil can trap heat or melt, resulting in damage to the product and a shock or fire hazard.
- Avoid scratching or impacting glass doors or control panels. Doing so may lead to glass breakage. Do not cook on a product with broken glass. Shock, fire or cuts may occur.
- Cook meat and poultry thoroughly—meat to at least an internal temperature of 160°F and poultry to at least an internal temperature of 180°F. Cooking to these temperatures usually protects against foodborne illness.

## SAVE THESE INSTRUCTIONS

**⚠ WARNING****KEEP FLAMMABLE MATERIALS AWAY FROM THE OVEN**

Failure to do so may result in fire or personal injury.

- Do not store or use flammable materials in or near an oven, including paper, plastic, pot holders, linens, wall coverings, curtains, drapes and gasoline or other flammable vapors and liquids.
- Never wear loose-fitting or hanging garments while using the appliance. These garments may ignite if they contact hot surfaces, causing severe burns.
- Do not let cooking grease or other flammable materials accumulate in or near the oven. Grease in the oven or near the oven may ignite.

**⚠ WARNING****IN THE EVENT OF A FIRE, TAKE THE FOLLOWING STEPS TO PREVENT INJURY AND FIRE SPREADING**

- Do not use water on grease fires. Never pick up a flaming pan.
- If there is a fire in the oven during baking, smother the fire by closing the oven door and turning the oven off or by using a multi-purpose dry chemical or foam-type fire extinguisher.
- If there is a fire in the oven during self-clean, turn the oven off and wait for the fire to go out. Do not force the door open. Introduction of fresh air at self-clean temperatures may lead to a burst of flame from the oven. Failure to follow this instruction may result in severe burns.

**⚠ WARNING****OVEN SAFETY INSTRUCTIONS**

- Stand away from the oven when opening the oven door. Hot air or steam which escapes can cause burns to hands, face and/or eyes.
- Keep the oven vent unobstructed.
- Keep the oven free from grease buildup. Grease in the oven may ignite.
- Place oven racks in desired location while oven is cool. If rack must be moved while oven is hot, do not let pot holder contact hot heating element in oven.
- When using cooking or roasting bags in the oven, follow the manufacturer's directions.
- Pulling out the standard racks to their stop-locks or the extension rack to its fully open position is a convenience in lifting heavy foods. It is also a precaution against burns from touching hot surfaces of the door or oven walls.
- Do not leave items such as paper, cooking utensils or food in the oven when not in use. Items stored in an oven can ignite.
- Do not use aluminum foil to line the oven bottom. Foil can trap heat or melt, resulting in damage to the product and a shock or fire hazard.

**⚠ WARNING****SELF-CLEANING OVEN SAFETY INSTRUCTIONS**

The self-cleaning feature operates the oven at temperatures high enough to burn away food soils in the oven. Follow these instructions for safe operation.

- Do not touch oven surfaces during self-clean operation. Keep children away from the oven during self-cleaning. Failure to follow these instructions may cause burns.
- Before self-cleaning the oven, remove shiny silver colored oven racks (on some models), the probe, any aluminum foil, and any broiler pan, grid, and other cookware. Only porcelain coated oven racks may be left in the oven.
- Before operating the self-clean cycle, wipe grease and food soils from the oven. Excessive amount of grease may ignite, leading to smoke damage to your home.
- If the self-cleaning mode malfunctions, turn the oven off and disconnect the power supply. Have it serviced by a qualified technician.
- Do not clean the door gasket. The door gasket is essential for a good seal. Care should be taken not to rub, damage or move the gasket.
- Do not use oven cleaners. No commercial oven cleaner or oven liner protective coating of any kind should be used in or around any part of the oven.

**SAVE THESE INSTRUCTIONS**

# IMPORTANT SAFETY INFORMATION. READ ALL INSTRUCTIONS BEFORE USING.

---

The remote enable equipment installed on this oven has been tested and found to comply with the limits for a Class B digital device, pursuant to part 15 of the FCC Rules. These limits are designed to:

**(a)** provide reasonable protection against harmful interference in a residential installation. This equipment generates, uses and can radiate radio frequency energy and, if not installed and used in accordance with the instructions, may cause harmful interference to radio communications. However, there is no guarantee that interference will not occur in a particular installation. If this equipment does cause harmful interference to radio or television reception, which can be determined by turning the equipment off and on, the user is encouraged to try to correct the interference by one or more of the following measures:

- Reorient or relocate the receiving antenna.
- Increase the separation between the equipment and receiver.
- Connect the equipment into an outlet on a circuit different from that to which the receiver is connected.
- Consult the dealer or an experienced radio/TV technician for help.

**(b)** accept any interference received, including interference that may cause undesired operation of the device.

**Note** that any changes or modifications to the remote enable device installed on this oven that are not expressly approved by the manufacturer could void the user's authority to operate the equipment.

# Notes

---

# Thank You! ... for your purchase of a GE Brand appliance.

**Register Your Appliance:** Register your new appliance on-line at your convenience!

[www.geappliances.com/service\\_and\\_support/register/](http://www.geappliances.com/service_and_support/register/)

Timely product registration will allow for enhanced communication and prompt service under the terms of your warranty, should the need arise. You may also mail in the pre-printed registration card included in the packing material.

## GE Electric Range Warranty

### GEAppliances.com

All warranty service is provided by our Factory Service Centers, or an authorized Customer Care® technician. To schedule service on-line, visit us at [www.geappliances.com/service\\_and\\_support/](http://www.geappliances.com/service_and_support/), or call 800.GE.CARES (800.432.2737). Please have serial number and model number available when calling for service.

Servicing your appliance may require the use of the onboard data port for diagnostics. This gives a GE factory service technician the ability to quickly diagnose any issues with your appliance and helps GE improve its products by providing GE with information on your appliance. If you do not want your appliance data to be sent to GE, please advise your technician not to submit the data to GE at the time of service.

For the period of one year from the date of the original purchase. GE will provide any part of the range which fails due to a defect in materials or workmanship. During this limited one-year warranty, GE will also provide, free of charge, all labor and in-home service to replace the defective part.

### What GE will not cover:

- Service trips to your home to teach you how to use the product.
- Improper installation, delivery or maintenance.
- Failure of the product if it is abused, misused, modified or used for other than the intended purpose or used commercially.
- Replacement of house fuses or resetting of circuit breakers.
- Damage to the product caused by accident, fire, floods or acts of God.
- Incidental or consequential damage caused by possible defects with this appliance.
- Damage caused after delivery.
- Product not accessible to provide required service.

### EXCLUSION OF IMPLIED WARRANTIES

Your sole and exclusive remedy is product repair as provided in this Limited Warranty. Any implied warranties, including the implied warranties of merchantability or fitness for a particular purpose, are limited to one year or the shortest period allowed by law.

This warranty is extended to the original purchaser and any succeeding owner for products purchased for home use within the USA. If the product is located in an area where service by a GE Authorized Servicer is not available, you may be responsible for a trip charge or you may be required to bring the product to an Authorized GE Service location for service. In Alaska, the warranty excludes the cost of shipping or service calls to your home.

Some states do not allow the exclusion or limitation of incidental or consequential damages. This warranty gives you specific legal rights, and you may also have other rights which vary from state to state. To know what your legal rights are, consult your local or state consumer affairs office or your state's Attorney General.

**Warrantor: General Electric Company, Louisville, KY 40225**

**Extended Warranties:** Purchase a GE extended warranty and learn about special discounts that are available while your warranty is still in effect. You can purchase it on-line anytime

[www.geappliances.com/service\\_and\\_support/shop-for-extended-service-plans.htm](http://www.geappliances.com/service_and_support/shop-for-extended-service-plans.htm)

or call 800.626.2224 during normal business hours. GE Consumer Home Services will still be there after your warranty expires.

Staple your receipt here. Proof of the original purchase date is needed to obtain service under the warranty.

# Have a question or need assistance with your appliance?

Try the GE Appliances Website ([www.geappliances.com/service\\_and\\_support/](http://www.geappliances.com/service_and_support/)) 24 hours a day, any day of the year! For greater convenience and faster service, you can now download Owner's Manuals, order parts or even schedule service on-line.

**Schedule Service:** Expert GE repair service is only one step away from your door. Get on-line and schedule your service at [www.geappliances.com/service\\_and\\_support/](http://www.geappliances.com/service_and_support/) Or call 800.GE.CARES (800.432.2737) during normal business hours.

**Remote Connectivity:** For assistance with oven wireless network connectivity (for models with remote enable) , please call 1-800-220-6899.

**Parts and Accessories:** Individuals qualified to service their own appliances can have parts or accessories sent directly to their homes (VISA, MasterCard and Discover cards are accepted). Order on-line today, 24 hours every day or by phone at 800.626.2002 during normal business hours.

Instructions contained in this manual cover procedures to be performed by any user. Other servicing generally should be referred to qualified service personnel.

Caution must be exercised, since improper servicing may cause unsafe operation.

**Real Life Design Studio:** GE supports the Universal Design concept of products, services and environments that can be used by people of all ages, sizes and capabilities. We recognize the need to design for a wide range of physical and mental abilities and impairments. For details of GE's Universal Design applications, including kitchen design ideas for people with disabilities, check out our Website today. For the hearing impaired, please call 800.TDD.GEAC (800.833.4322).

**Contact Us:** If you are not satisfied with the service you receive from GE, contact us on our Website with all the details including your phone number, or write to:

**General Manager, Customer Relations**

**GE Appliances, Appliance Park Louisville, KY 40225**

## Accessories

### Looking For Something More?

GE offers a variety of accessories to improve your cooking and maintenance experiences!

To place an order visit us online at:

[www.GEApplianceParts.com](http://www.GEApplianceParts.com) (U.S.) or [www.GEAppliances.ca](http://www.GEAppliances.ca) (Canada)

or call **800.626.2002** (U.S.) **800.661.1616** (Canada)

The following products and more are available:

#### Accessories

Small Broiler Pan (8 ¾" x 1 ¼" x 13 ½")	WB48X10055 (US) 222D2097G001 (Canada)
Large* Broiler Pan (12 ¾" x 1 ¼" x 16 ½")	WB48X10056 (US) 222D2097G002 (Canada)
XL** Broiler Pan (17" x 1 ¼" x 19 1/4")	WB48X10057 (US) Not available in Canada

#### Parts

Oven racks	Part numbers vary by model
Oven elements	Part numbers vary by model
Light bulbs	Part numbers vary by model
Probe	Part numbers vary by model

#### Cleaning Supplies

CitruShine Stainless Steel Wipes	WX10X10007
CeramaBryte Stainless Steel Appliance Cleaner	PM10X311
Graphite Lubricant	WB02T10303

\*The large broiler pan does not fit in 20"/24" ranges.

\*\*The XL broiler pan does not fit in 24" wall ovens, 27" drop ins or 20"/24" ranges

## How to Remove Protective Shipping Film and Packaging Tape

Carefully grasp a corner of the protective shipping film with your fingers and slowly peel it from the appliance surface. Do not use any sharp items to remove the film. Remove all of the film before using the appliance for the first time.

To assure no damage is done to the finish of the product, the safest way to remove the adhesive from packaging tape on new appliances is an application of a household liquid dishwashing detergent. Apply with a soft cloth and allow to soak.

**NOTE:** The adhesive must be removed from all parts. It cannot be removed if it is baked on.

# Single Wall Oven

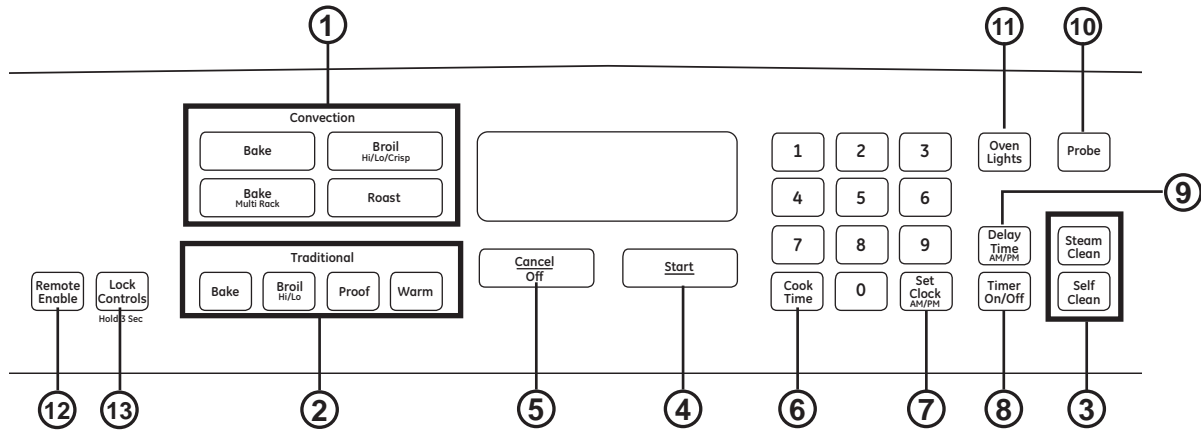

1. **Convection Cooking Modes:** Convection cooking modes use increased air circulation to improve performance. The type of benefit depends on the mode. Your oven has the following convection cooking modes: Bake, Bake Multi Rack, Roast, Broil Hi, Broil Lo, and Broil Crisp. See the Cooking Modes section for more information.
2. **Traditional Cooking Modes:** Your oven has the following traditional cooking modes: Bake, Broil Hi, Broil Lo, Proof and Warm. See the Cooking Modes section for more information.
3. **Clean:** Your oven has two cleaning modes: Self Clean and Steam Clean. See the Cleaning the Oven section for important information about using these modes.
4. **Start:** Must be pressed to start any cooking, cleaning, or timed function.
5. **Cancel/Off:** Cancels ALL oven operations except the clock and timer.
6. **Cook Time:** Counts down cooking time and turns off the oven when the cooking time is complete. Press the **Cook Time** pad, use the number pads to program a cooking time in hours and minutes, then press **Start**. This can only be used with Traditional Bake, Convection Bake, Convection Bake Multi, and Convection Roast.
7. **Clock:** Sets the oven clock time. Press the **Clock** pad and the number pads to program the clock. Make sure to select **AM** or **PM**. Press **Start** to save the time.
8. **Timer:** Works as a countdown timer. Press the **Timer** pad and the number pads to program the time in hours and minutes. Press the **Start** pad. The oven will continue to operate when the timer countdown is complete. To turn the timer off press the **Timer** pad.
9. **Delay Time:** Delays when the oven will turn on. Use this to set a time when you want the oven to start. Press the **Delay Time** pad and use the number pads to program the time of day for the oven to turn on. Press the desired cooking mode and temperature then press **Start**. A cook time may also be programmed if desired. This can only be used with Traditional Bake, Convection Bake, Convection Bake Multi Rack, Convection Roast and Self-Clean.
10. **Probe:** Monitors internal food temperature and turns the oven off when the food reaches the programmed temperature. Insert the probe, program the cooking mode, and program the probe temperature. See the Cooking Modes section for more information. The probe can only be used with Traditional Bake, Convection Bake, and Convection Roast.
11. **Oven Light(s):** Turns the oven light(s) on or off.
12. **Remote Enable (on some models):** Allows the oven to be operated remotely. Once connectivity is established, pressing the **Remote Enable** pad allows the oven to be operated from a mobile device. Opening the oven door while the oven is idle, or ending a cook cycle ends this capability and requires the button to be pressed again to enable remote operation. Both the  and the remote enable light in the display must be solid and lit to allow remote operation. If either the icon or the remote enable light are not lit or are blinking, the remote enable feature will not work. Additional guidance is provided in the included insert and through the mobile app.
13. **Lock Controls:** Locks out the control so that pressing the pads does not activate the controls. Press and hold the **Lock Controls** pad for three seconds to lock or unlock the control. **Cancel/Off** is always active, even when the control is locked.



# Double Wall Oven

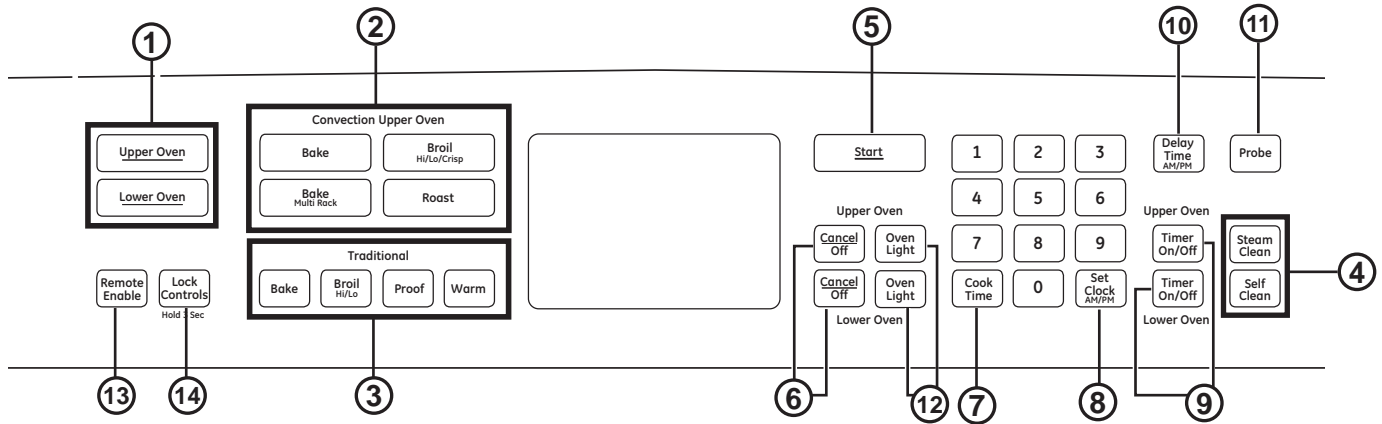

1. **Upper Oven and Lower Oven:** Designates which oven to use. Press the **Upper Oven** or **Lower Oven** pad to select an oven, then press the desired cooking mode pad. The oven control will default to the upper oven.
2. **Convection Cooking Modes:** Convection cooking modes use increased air circulation to improve performance. The type of benefit depends on the mode. Your oven has the following convection cooking modes: Bake, Bake Multi Rack, Roast, Broil Hi, Broil Lo, and Broil Crisp. See the Cooking Modes section for more information.
3. **Traditional Cooking Modes:** Your oven has the following traditional cooking modes: Bake, Broil Hi, Broil Lo, Proof and Warm. See the Cooking Modes section for more information.
4. **Clean:** Your oven has two cleaning modes: Self Clean and Steam Clean. See the Cleaning the Oven section for important information about using these modes.
5. **Start:** Must be pressed to start any cooking, cleaning, or timed function.
6. **Cancel/Off:** Cancels ALL oven operations except the clock and timer.
7. **Cook Time:** Counts down cooking time and turns off the oven when the cooking time is complete. Press the **Cook Time** pad, use the number pads to program a cooking time in hours and minutes, then press **Start**. This can only be used with Traditional Bake, Convection Bake, Convection Bake Multi, and Convection Roast.
8. **Clock:** Sets the oven clock time. Press the **Clock** pad and the number pads to program the clock. Make sure to select **AM** or **PM**. Press **Start** to save the time.
9. **Timer:** Works as a countdown timer. Press the **Timer** pad and the number pads to program the time in hours and minutes. Press the **Start** pad. The oven will continue to operate when the timer countdown is complete. To turn the timer off press the **Timer** pad.
10. **Delay Time:** Delays when the oven will turn on. Use this to set a time when you want the oven to start. Press the **Delay Time** pad and use the number pads to program the time of day for the oven to turn on. Press the desired cooking mode and temperature then press **Start**. A cook time may also be programmed if desired. This can only be used with Traditional Bake, Convection Bake, Convection Bake Multi Rack, Convection Roast and Self-Clean  
**NOTE:** When using the delay time feature, foods that spoil easily—such as milk, eggs, fish, stuffings, poultry and pork—should not be allowed to sit for more than 1 hour before or after cooking. Room temperature promotes the growth of harmful bacteria. Be sure that the oven light is off because heat from the bulb will speed harmful bacteria growth.
11. **Probe:** Monitors internal food temperature and turns the oven off when the food reaches the programmed temperature. Select upper or lower, insert the probe, program the cooking mode, and program the probe temperature. See the Cooking Modes section for more information. The probe can only be used with Traditional Bake, Convection Bake, and Convection Roast.
12. **Oven Light(s):** Turns the oven light(s) on or off.
13. **Remote Enable (on some models):** Allows the oven to be operated remotely. Once connectivity is established, pressing the **Remote Enable** pad allows the oven to be operated from a mobile device. Opening the oven door while the oven is idle, or ending a cook cycle ends this capability and requires the button to be pressed again to enable remote operation. Both the  and the remote enable light in the display must be solid and lit to allow remote operation. If either the icon or the remote enable light are not lit or are blinking, the remote enable feature will not work. Additional guidance is provided in the included insert and through the mobile app.
14. **Lock Controls:** Locks out the control so that pressing the pads does not activate the controls. Press and hold the **Lock Controls** pad for three seconds to lock or unlock the control. **Cancel/Off** is always active, even when the control is locked.

# Special Features

There are numerous special features that are controlled using the number key pad.

- Degree - Fahrenheit or Celsius temperature display
- End tone - Cycle End Tone
- Sound - Tone Volume
- Setting - Clock Setting
- Auto Recipe - Auto Recipe Conversion (for Convection Baking)
- 12hr shutoff - 12 Hour Shutoff
- Sabbath - Sabbath mode
- Temp Offset - Adjust the oven temperature (Double ovens have upper and lower options)
- Notification Light Bar - Turns the light indicator on or off
- Default - Reset control to factory settings

To change the Special Features settings follows these guidelines.

Press and hold the **Traditional Bake** and **Traditional Broil** pads for 3 seconds simultaneously.

When you enter the special features mode:

- The numbers **2** and **8** act as up and down to scroll thru the features and their settings.
- The numbers **4** and **6** act as right and left to change back and forth from scrolling thru the features to changing the feature settings.
- The number **5** acts as an enter pad.

Press and hold the **Traditional Bake** and **Traditional Broil** pads for 3 seconds simultaneously to exit the special feature mode.

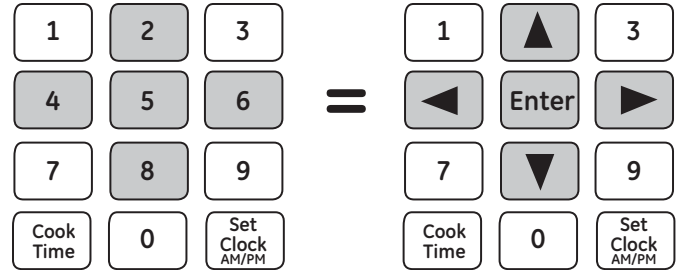

Example: Adjusting the Oven Temperature

1. Press and hold the **Traditional Bake** and **Traditional Broil** pads for 3 seconds simultaneously to enter special features mode.
2. Press the number **2** pad until the display reads "Temp Offset" (double wall ovens will have a selection for both the upper and lower ovens).
3. Press the number **6** pad to change the special feature setting.
4. Press the number **2** or **8** pads to either increase or decrease the temperature in one degree Fahrenheit increments up to + 35° F or down to -35° F.
5. Press the number **5** pad to save your desired change.
6. Press the number **4** pad to return to the other features.
7. Press and hold the **Traditional Bake** and **Traditional Broil** pads for 3 seconds simultaneously to exit the special feature mode.

## Fahrenheit or Celsius Temperature Display

Your oven control is set to use Fahrenheit temperature units but can be changed to use Celsius temperature units if preferred.

## Cycle End Tone

This is the tone that signals the end of a timer. You can change it to be one tone (bEEP) or a continuous repeating tone (con).

## Tone Volume

This feature allows the oven tone volume to be adjusted between high, medium (default), low, and off.

## Clock Setting

This feature specifies how the time of day will be displayed. Options are for a standard 12-hour clock with AM and PM selections, 24-hour military time display, or for no display.

## Auto Recipe Conversion

When using Convection Bake or Convection Bake Multi cooking modes, Auto Recipe conversion will automatically reduce the programmed cooking temperature. Note that this option does not convert convection baking times, only temperatures.

## 12-hour Shutoff

When this feature is turned on, the oven will automatically turn off after 12 continuous hours of use.

## Default

This feature resets all of the special features to the default settings originally on the oven.

## Special Features (cont.)

### Adjust the Oven Temperature (Upper and Lower on some models)

This feature allows the oven temperature to be adjusted up to 35°F hotter or down to 35°F cooler. Use this feature if you believe your oven temperature is too hot or too cold and wish to change it. **For double oven models the upper and lower ovens are adjusted separately.** This adjustment affects Traditional Bake, Convection Bake, and Convection Bake Multi Rack modes.

### Notification Light Bar (on some models)

This feature uses a light bar between the door and the control panel for easy visual indication of preheat and cook time status. This feature can be turned on or off in the special features of your oven. This feature works with Convection Bake, Convection Bake Multi, Convection Broil, Convection Roast, Traditional Bake, Traditional Broil, Warm, Proof, Self Clean, Cook Time and Timer. On a double wall oven the notification lighting indicates the status of the upper oven only. Below is a description of the different light conditions.

 **OFF** - No oven or timer function is running or the feature has been turned off in special features.

 **PULSING BAR** - The oven is pre-heating. The light bar will pulse until the oven set temperature has been reached.

 **PROGRESS BAR** - Will slowly progress to a fully lit bar as the timer counts down.

**NOTE:** If the **Cook Time** button is used, the light bar and the oven will turn off when the time reaches zero. If **Timer** button is used the light bar will remain solid when time reaches zero.

 **SOLID BAR** - The oven is at the set temperature and/or function or your kitchen timer is complete.

**NOTE:** The progress bar for timed functions takes priority over the solid or pulsating functions if both are being used at the same time.

### Sabbath

Sabbath mode disables the oven lights, (the oven light will not turn on when the door is opened and the notification light bar will be disabled), all sounds (the control will not beep when a button is pressed), Convection modes, Broil modes, Warm, Proof, Cook Time, Timer, Clock, and Delay Time functions. Sabbath mode can only be used with Bake. This feature conforms to the Star-K Jewish Sabbath requirements.

Press and hold the **Traditional Bake** and **Traditional Broil** pads for 3 seconds to enter special features mode. Use the number **2** or **8** pad to scroll thru the special features options to "SAbbAtH" and then press

the number **6** pad to allow the number **2** or **8** pad to change the Sabbath feature setting from "oFF" to "on".

Press the number **5** pad to enter the selection. Press and hold the **Traditional Bake** and **Traditional Broil** pads for 3 seconds to exit special features mode. A ] will appear in the display and the clock will not display.

Note that if you have a double wall oven, when you place the control into Sabbath mode, both ovens are now in Sabbath mode and available for cooking.

Once in Sabbath mode, at any time you can press **Bake**, the control will start at 350F but you can use the number pads to enter a different temperature between 170F and 550F if necessary, and then press **Start**. No sound will be given when the keys are pressed. At a random time between 30 seconds and 1 minute, ]], will appear in the display indicating the oven is running.

Note that both ovens of a double wall oven can be used in Sabbath mode. Each oven can be programmed to a different temperature and each oven must be programmed separately. When programming both ovens, please wait until one oven is running before starting the second oven.

If you need to adjust the temperature, press **Bake**, use the number pads to enter a new temperature between 170F and 550F, and press **Start**.

To turn the oven off, press **Cancel/Off** at any time. The oven will immediately turn off and the, ]], will change to ] indicating that the oven has turned off.

Note that each oven of a double wall oven must be turned off separately.

To exit Sabbath mode, first turn the oven off. Then press and hold the **Traditional Bake** and **Traditional Broil** pads for 3 seconds to enter special features mode. You will not be able to enter special features mode if the oven is not turned off.

Use the number **2** or **8** pad to scroll thru the special features options to "SAbbAth" and then press the **6** pad to allow the number **2** or **8** pad to change the Sabbath feature setting from "on" to "oFF".

Press the number 5 pad to enter the selection. Then press and hold the **Traditional Bake** and **Traditional Broil** pads for 3 seconds to exit special features mode.

**NOTE:** If power outage occurs during Sabbath mode the unit will remain in Sabbath mode but off when power is restored.

If you wish to use the Cook Time feature to bake in the oven and then have the oven automatically turn off, do not enter Sabbath mode. You will need to change the End Tone from a continuous beep to a single beep, turn the Tone Volume off, and turn the oven light on using the control panel or remove the light bulb and then you can program the oven for the desired cook time in bake.

# Oven Racks

Your oven has six rack positions. Recommended rack positions for various types of foods are provided in the Cooking Guide. Adjusting rack position is one way to impact cooking results. For example, if you would prefer darker tops on cakes, muffins, or cookies, try moving food one rack position higher. If you find foods are too brown on top try moving them down next time.

When baking with multiple pans and on multiple racks, ensure there is at least 1½" between pans to allow sufficient space for air to flow.

## Oven Racks

Your oven may have extension racks and/or traditional flat racks.

To avoid possible burns, place the racks in the desired position before you turn the oven on.

## Extension Racks

Extension racks have a frame that locks into the rack supports on both sides. Once the frame is locked into place, always pull the rack out, by its upper front rail, to its full extension stop position, when placing or removing cookware.

If extension racks are difficult to extend, lubricate the racks with the graphite lubricant provided with your oven. Remove the rack from the oven, remove debris in the slide tracks with a paper towel, shake the graphite lubricant and place 4 small drops on the two bottom tracks of the left and right sides. Open and close the rack several times to distribute the lubricant.

To order additional graphite lubricant, read the Assistance and Accessories section at the beginning of this manual.

### To Remove An Extension Rack:

1. Make sure the rack is pushed all the way into the oven.
2. Grasp the rack by both its upper front rail and its lower front rail and lift straight up to unlock the front rack locks from the rack supports.
3. Firmly holding onto both the upper and lower front rails, pull the rack forward and remove it from the oven.

### To Replace An Extension Rack:

1. Place the rear rack locks over and onto the rack supports.
2. Slide the rack all the way in until the rear rack locks are secure on the rear rack supports and press the front rack locks onto the front rack supports.

If extension racks are difficult to replace or remove, wipe the oven rack supports with cooking oil. Do not wipe oil on the rack slides.

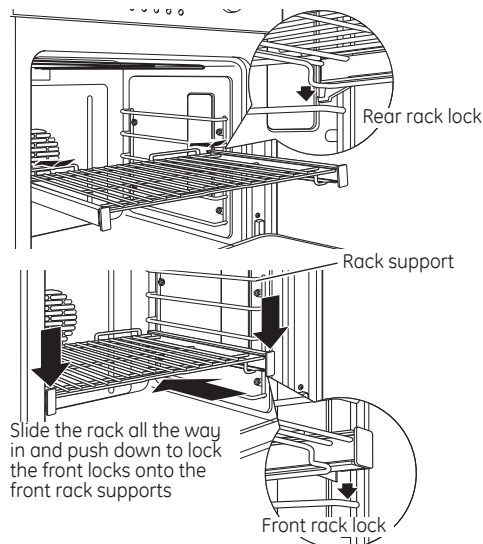
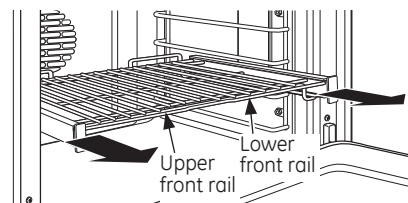
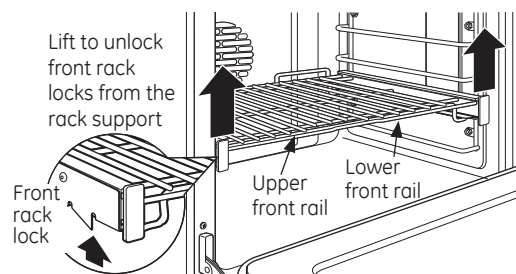
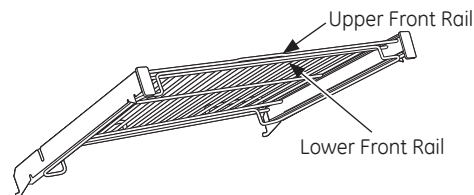
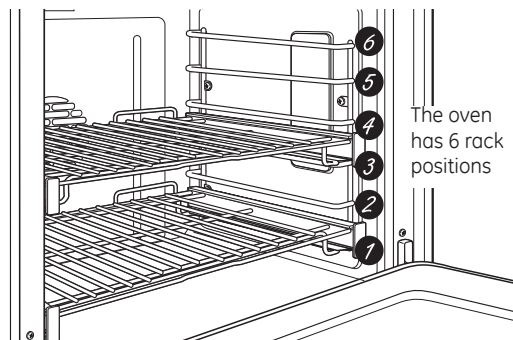

## Oven Racks (cont.)

### Traditional Flat Racks

The racks have stops so that when placed correctly on the supports they will stop before coming completely out and will not tilt. When placing and removing cookware, pull the rack out until it stops.

#### To Remove a Rack

Pull it toward you, tilt the front end up and pull it out.

#### To Replace a Rack

Tilt the front of the rack up, hook the rear locating posts under the rack supports, push the rack back (past the stop-locks) and lower it into position. Push the rack all the way in.

If flat racks are difficult to slide and/or remove, place some cooking oil on a soft cloth or paper towel and rub onto the sides of the rack and each rack support.

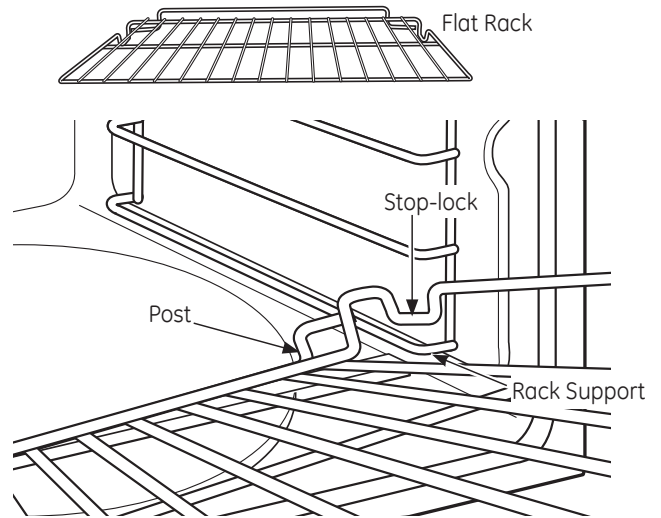

**⚠ CAUTION:** Use caution when removing a rack from lowest position as door may be hot.

**⚠ CAUTION:** Never place cooking utensils, aluminum foil, pizza or baking stones, or any other items on the oven floor. There is a heating element beneath the oven floor. Placing items on the oven floor may cause the oven to overheat, resulting in damage to the oven and risk of damage or fire to cabinets.

### Aluminum Foil

**Do not use aluminum foil to line oven bottoms.** The foil will trap heat below and upset the performance of the oven. Foil can melt and permanently damage the oven bottom. Damage from improper use of aluminum foil is not covered by the product warranty.

Foil may be used to catch spills by placing a sheet on a lower rack, several inches below the food. Do not use more foil than necessary and never entirely cover an oven rack with aluminum foil. Keep foil at least 1-1/2" from oven walls to prevent poor heat circulation.

## Cooking Modes

Your new oven has a variety of cooking modes to help you get the best results. These modes are described below. Refer to the Cooking Guide section for recommendations for specific foods. Remember, your new oven may perform differently than the oven it is replacing.

### Baking and Roasting Modes

Select a mode for baking and roasting based on the type and quantity of food you are preparing. When preparing baked goods such as cakes, cookies, and pastries always preheat the oven first. Follow recipe recommendations for food placement. If no guidelines are provided, center food in the oven.

#### Traditional Bake

The traditional bake mode is intended for single rack cooking. This mode uses heat primarily from the lower element but also from the upper element to cook food. To use this mode press the **Bake** pad under **Traditional**, enter a temperature, and then press **Start**. Preheating is generally recommended when using this mode.

#### Convection Bake with Direct Air

The Convection Bake mode is intended for single rack cooking. This mode uses heat from the lower element and also the upper and rear elements, along with air movement directly down from the top of the oven to enhance evenness. Your oven is equipped with Auto Recipe Conversion, so it is not necessary to convert the temperature when using this mode. To use this mode press the **Bake** pad under **Convection**, enter a temperature, and then press **Start**. Preheating is generally recommended when using this mode.

#### Convection Bake Multi Rack

The Convection Bake Multi Rack mode is intended for baking on multiple racks at the same time. This mode uses heat primarily from the rear element but also heat from the upper and lower elements, along with air movement from the convection fan to enhance cooking evenness. Your oven is equipped with Auto Recipe Conversion, so it is not necessary to convert the temperature when using this mode. Baking time might be slightly longer for multiple racks than what would be expected for a single rack. To use this mode press the **Bake Multi Rack** pad under **Convection**, enter a temperature, and then press **Start**. Always preheat when using this mode.

#### Convection Roast with Direct Air

The Convection Roast mode is intended for roasting whole cuts of meat on a single rack. This mode uses heat from the lower, upper, and rear elements along with air movement directly down from the top of the oven to improve browning and reduce cooking time. It is not necessary to convert temperature. Check food earlier than the recipe suggested time when using this mode, or use the probe. To use this mode press the **Roast** pad under **Convection**, enter a temperature, and then press **Start**. It is not necessary to preheat when using this mode.

### Broiling Modes

Always broil with the door closed. The broil element in this oven is very powerful. Monitor food closely while broiling. Use caution when broiling on upper rack positions as placing food closer to the broil element increases smoking, spattering, and the possibility of fats igniting. **Broiling on rack position 6 is not recommended.**

Try broiling foods that you would normally grill. Adjust rack positions to adjust the intensity of the heat to the food. Place foods closer to the broil element when a seared surface and rare interior is desired. Thicker foods and foods that need to be cooked through should be broiled on a rack position farther from the broiler or by using Traditional Broil Lo or Convection Broil Lo. For best performance, center food below the broil heating element.

#### Traditional Broil Hi

The Traditional Broil Hi mode uses intense heat from the upper element to sear foods. Use Broil Hi for thinner cuts of meat and/or foods you prefer less done on the interior. To use this mode press the **Broil** pad once under **Traditional** and then press **Start**. It is not necessary to preheat when using this mode.

#### Traditional Broil Lo

The Traditional Broil Lo mode uses less intense heat from the upper element to cook food thoroughly while also producing surface browning. Use Broil Lo for thicker cuts of meat and/or foods that you would like cooked all the way through. To use this mode press the **Broil** pad **twice** under **Traditional** and then press **Start**. It is not necessary to preheat when using this mode.

#### Convection Broil Hi with Direct Air

The Convection Broil Hi mode uses intense heat from the upper element along with air movement directly down from the top of the oven for improved searing and browning. To use this mode press the **Broil** pad once under **Convection** and then press **Start**. For best results preheat 5 minutes when using this mode.

#### Convection Broil Lo with Direct Air

The Convection Broil Lo mode uses less intense heat from the upper element along with air movement directly down from the top of the oven. To use this mode press the **Broil** pad **twice** under **Convection** and then press **Start**. For best results preheat 5 minutes when using this mode.

#### Convection Broil Crisp with Direct Air

The Convection Broil Crisp mode is intended as a finishing mode at the end of a cooking cycle to add surface browning to a dish such as a casserole or a roast. To use this mode press the **Broil** pad **three times** under **Convection** and then press **Start**. Monitor food closely to prevent over browning.

## Cooking Modes (Cont.)

### Proof

Proof mode is designed for rising (fermenting and proofing) bread doughs. Press the **Proof** pad and then press **Start**. Cover dough well to prevent drying out. Bread will rise more rapidly than at room temperature.

### Warm

Warm mode is designed to keep hot foods hot for up to 3 hours. To use this mode, press the **Warm** pad then press **Start**. Cover foods that need to remain moist and do not cover foods that should be crisp. Preheating is not required. Do not use warm to heat cold food other than crisping crackers, chips or dry cereal. It is also recommended that food not be kept warm for more than 2 hours.

### Probe

Internal food temperature is frequently used as an indicator of doneness, especially for roasts and poultry. The Probe mode monitors the internal food temperature and turns the oven off when the internal food temperature reaches the programmed temperature. Minimum temperatures for food safety can be found at [www.IsItDoneYet.gov](http://www.IsItDoneYet.gov). The temperature probe can only be used with Traditional Bake, Convection Bake, and Convection Roast modes.

To use the probe with preheating:

1. Press the desired cook mode (**Traditional Bake, Convection Bake, or Convection Roast**) pad and enter the desired cooking temperature.
2. Insert the probe into the food (see Proper Probe Placement Guidelines in this section).
3. Once the oven is preheated, place the food in the oven and connect the probe to the probe outlet, making sure it is fully inserted. Use caution, the oven walls and probe outlet are hot.
4. Program the probe temperature by pressing the **Probe** pad and entering the desired food temperature. The maximum internal food temperature that you can set is 200° F.

To use the probe without preheating:

1. Insert the probe into the food (see Proper Probe Placement Guidelines in this section).
2. Place the food in the oven and connect the probe into the probe outlet in the oven.

3. Program the desired probe and cooking mode settings by pressing the **Probe** pad and entering the desired food temperature, then pressing the cook mode pad (**Traditional Bake, Convection Bake, or Convection Roast**) and entering the desired cooking temperature.

### Proper Probe Placement Guidelines

After preparing the meat and placing it on the cooking pan follow these guidelines for proper probe placement.

- Insert the probe completely into the meat, up to the handle, such that the point of the probe will rest in the center of the thickest part of the meat.
- The probe should not touch bone, fat or gristle.
- For whole poultry insert the probe into the thickest part of the breast.
- For boneless roasts, insert the probe into the center of the roast.
- For bone-in ham or lamb, insert the probe into the center of the lowest large muscle or joint.
- For casseroles or dishes such as meatloaf, insert the probe into the center of the dish.
- For fish, insert the probe from just above the gill into the meatiest area, parallel to the backbone.

Check the temperature at other locations in the food with a food thermometer once the probe temperature is reached to ensure that all portions of the food have reached desired temperatures.

### Probe Care Guidelines

Note: some double oven models have a probe in the upper oven only.

- Use of probes other than the one provided with this product may result in damage to the probe.
- Use the handles of the probe and plug when inserting and removing them from the meat and outlet
- To avoid damaging your probe, do not use tongs to pull on the cable when removing it.
- To avoid breaking the probe, make sure food is completely defrosted before inserting the probe.
- To prevent possible burns, do not unplug the probe from the outlet until the oven has cooled.
- Never leave the probe inside the oven during a self or steam clean cycle.
- Do not store the probe in the oven.

## Cookware

### Cookware Guidelines

The material, finish, and size of cookware affect baking performance.

Dark, coated and dull pans absorb heat more readily than light, shiny pans. Pans that absorb heat more readily can result in a browner, crisper, and thicker crust. If using dark and coated cookware check food earlier than minimum cook time. If undesirable results are obtained with this type of cookware consider reducing oven temperature by 25° F next time.

Shiny pans can produce more evenly cooked baked goods such as cakes and cookies.

Glass and ceramic pans heat slowly but retain heat well. These types of pans work well for dishes such as pies and custards.

Air insulated pans heat slowly and can reduce bottom browning.

Keep cookware clean to promote even heating.

# Cooking Guide

FOOD TYPE	RECOMMENDED MODE(S)	RECOMMENDED RACK POSITION(S)	ADDITIONAL SUGGESTIONS
<b>Baked Goods</b>			
Layer cakes, sheet cakes, bundt cakes, muffins, quick breads on a Single Rack	Convection Bake Traditional Bake	3	Use shiny cookware.
Layer cakes* on Multiple Racks	Traditional Bake	2 and 4	Extension rack in higher position if used. Ensure adequate airflow (see illustration below).
Chiffon cakes (angel food)	Convection Bake Traditional Bake	1	Use shiny cookware.
Cookies, biscuits, scones on a Single Rack	Convection Bake	3	Use shiny cookware.
Cookies, biscuits, scones on Multiple Racks	Convection Bake Multi Rack	2 and 4 2, 3 and 5	Extension rack position 4 for 2 racks, and position 3 for 3 racks. Ensure adequate airflow.
<b>Beef &amp; Pork</b>			
Hamburgers	Traditional Broil Hi	5	Use extension rack; move food down for more doneness/less searing. Watch food closely when broiling. For best performance, center food below the broil heating element.
Steaks & Chops	Convection Broil Hi Traditional Broil Hi	5	Use a broil pan; Preheat 5 minutes if using Convection Broil Mode. Move food down for more doneness/less searing. Watch food closely when broiling. For best performance, center food below the broil heating element.
Roasts	Convection Roast	2 or 3	Use a low sided pan such as a broil pan. Preheating is not necessary. Use probe feature.
<b>Poultry</b>			
Whole chicken	Convection Roast	2 or 3	Use a low sided pan such as a broil pan. Use probe feature.
Bone-in chicken breasts, legs, thighs	Broil Hi	1	If breaded or coated in sauce avoid Broil Hi modes. Broil skin side down first. Watch food closely when broiling. For best performance when broiling, center food below the broil heating element.
	Broil Lo Convection Bake Traditional Bake	3	
Boneless chicken breasts	Convection Broil Lo Convection Bake Traditional Bake	3	Preheat 5 minutes if using Convection Broil. Move food down for more doneness/less searing and up for greater searing/browning when broiling. For best performance when broiling, center food below the broil heating element.
Whole turkey	Convection Roast	1 or 2	Use a low sided pan such as a broil pan. Use the probe feature.
Turkey Breast	Convection Roast	2 or 3	Use a low sided pan such as a broil pan. Use the probe feature.
<b>Fish</b>	Convection Broil Lo Broil Lo	5 (1/2 thick or less) 4 (>1/2 inch)	Preheat 5 minutes when Convection Broiling. Watch food closely when broiling. For best performance, center food below the broil heating element.
<b>Casseroles</b>	Convection Bake Traditional Bake	3	Use Convection Broil Crisp mode during last 2-5 minutes of baking to melt/brown cheese or crisp surface.
<b>Frozen Convenience Foods</b>			
Pizza, french fries, tator tots, chicken nuggets, appetizers on a Single Rack	Convection Bake Traditional Bake	3	Use Convection Broil Crisp mode during last 2-5 minutes of cooking to crisp the exterior.
Pizza, french fries, tator tots, chicken nuggets, appetizers on Multiple Racks	Convection Bake Multi Rack	2 and 4	If using Crisp mode, place both pans on top rack if space allows, otherwise Crisp one at a time on top rack position.

\*When baking four cake layers at a time, use racks 2 and 4. Place the pans as shown so that one pan is not directly above another.

Cook food thoroughly to help protect against food borne illness. Minimum safe food temperature recommendations for food safety can be found at [www.IsItDoneYet.gov](http://www.IsItDoneYet.gov). Make sure to use a food thermometer to take food temperatures.

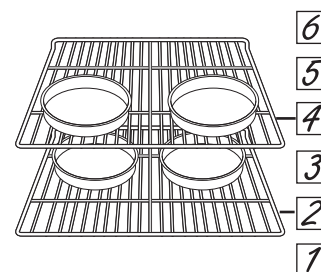



# Cleaning The Oven

Be sure electrical power is off and all surfaces are cool before cleaning any part of the oven.

## Control Panel

It's a good idea to wipe the control panel after each use. Clean with mild soap and water or vinegar and water, rinse with clean water and polish dry with a soft cloth.

Do not use abrasive cleansers, strong liquid cleansers, plastic scouring pads or oven cleaners on the control panel—they will damage the finish.

## Oven Exterior

Do not use oven cleaners, abrasive cleansers, strong liquid cleansers, steel wool, plastic scouring pads, or cleaning powders on the interior or exterior of the oven. Clean with a mild soap and water or vinegar and water solution. Rinse with clean water and dry with a soft cloth. When cleaning surfaces, make sure that they are at room temperature and not in direct sunlight.

If stain on the door vent trim is persistent, use a mild abrasive cleaner and a sponge-scrubber for best results.

Spillage of marinades, fruit juices, tomato sauces and basting liquids containing acids may cause discoloration and should be wiped up immediately. Let hot surfaces cool, then clean and rinse.

## Stainless Steel Surfaces (on some models)

Do not use a steel wool pad; it will scratch the surface.

To clean the stainless steel surface, use warm sudsy water or a stainless steel cleaner or polish. Always wipe the surface in the direction of the grain. Follow the cleaner instructions for cleaning the stainless steel surface.

To inquire about purchasing cleaning products including stainless steel appliance cleaner or polish, read the Assistance and Accessories sections at the beginning of this manual.

## Oven Interior

The interior of your new oven can be cleaned manually or by using the Steam Clean or Self Clean modes.

Spillage of marinades, fruit juices, tomato sauces and basting liquids containing acids may cause discoloration and should be wiped up immediately. Let hot surfaces cool, then clean and rinse.

### Manual Cleaning

Do not use oven cleaners, abrasive cleaners, strong liquid cleansers, steel wool, scouring pads, or cleaning powders on the interior of the oven. Clean with a mild soap and water or vinegar and water solution. Rinse with clean water and dry with a soft cloth. When cleaning surfaces, make sure that they are at room temperature.

### Steam Clean Mode

Steam clean is intended to clean small spills using water and a lower cleaning temperature than Self-Clean.

To use the Steam Clean feature, wipe grease and soils from the oven. Pour one cup of water into the bottom of the oven. Close the door. Press the **Steam Clean** pad and then press **Start**. The oven door will lock. You can not open the door during the 30 minute steam clean as this will decrease the steam clean performance. At the

end of the steam clean cycle the door will unlock. Wipe out any excess water and any remaining soil.

### Self Clean Mode

Read Self-Cleaning Oven Safety Instructions at the beginning of this manual before using Self Clean Mode. Self clean uses very high temperatures to clean the oven interior. The oven door will lock when using this feature. Before operating the self clean cycle, wipe up grease and soils from the oven. Remove all items from the oven other than enameled (dark color) racks. Shiny or silver racks, the meat probe, and any cookware or other items should all be removed from the oven before initiating a self clean cycle. Close the door. Press the **Self Clean** pad and a default self-clean time is displayed. The clean time can be changed to any time between 3:00 and 5:00 hours by using the number pads to enter a different time and pressing **Start**. For heavily soiled ovens, the maximum 5 hour clean time is recommended. If you wish to use the default time, press the **Start** pad immediately after pressing the **Self Clean** pad. The oven will turn off automatically when the self clean cycle is complete. The door will stay locked until the oven has cooled down. After the oven has cooled down wipe any ash out of the oven.

## Oven Racks

The racks that were provided with your oven (dark enameled racks, not shiny) may remain in the oven during the self-cleaning cycle without being damaged.

To manually clean racks, use warm, soapy water. Make sure not to wash the rack slides on an extension rack.

If racks become more difficult to remove from the oven, put some vegetable oil on a soft cloth or paper towel and rub onto the oven rack supports. Do not wipe the oil on an extension rack slide.

Periodically, after several self-clean cycles, the extension rack slides may need to be lubricated using the graphite lubricant shipped with your wall oven. To order additional graphite lubricant read the Assistance and Accessories sections at the beginning of this manual.

1. Remove extension rack from the oven. See the Extension Oven Racks section.
2. Fully extend the rack on a table or countertop. Newspaper may be placed underneath the rack for easy clean up.
3. If there is debris in the slide tracks, wipe it away using a paper towel. **NOTE:** Any graphite lubricant wiped away must be replaced.
4. Shake the graphite lubricant before opening it. Starting with left slide mechanism of the rack, place four (4) small drops of lubricant on the two (2) bottom tracks of the slide close to the bearing carriers.
5. Repeat for the right slide mechanism of the rack.
6. Open and close the rack several times to distribute the lubricant.
7. Replace the cap on the lubricant and shake it again. Turn the rack over and repeat steps 3, 4, 5 and 6.
8. Close the rack, turn rack right-side-up and place in the oven. See the Extension Oven Racks section.
9. Repeat above steps for each rack.

**NOTE:** Do not spray with cooking spray or other lubricant sprays.

### Probe

The temperature probe may be cleaned with soap and water or a soap-filled scouring pad. Cool the temperature probe before cleaning. Scour stubborn spots with a soap-filled scouring pad, rinse and dry.

To order additional temperature probes read the Assistance and Accessories sections at the beginning of this manual.

- Do not immerse the temperature probe in water.
- Do not store the temperature probe in the oven.
- Do not leave the temperature probe inside the oven during a self or steam clean cycle.

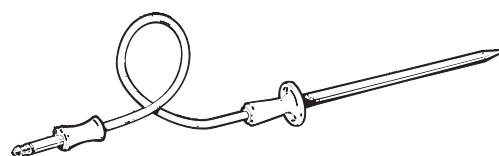
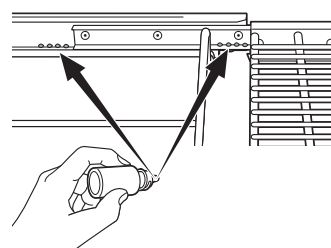
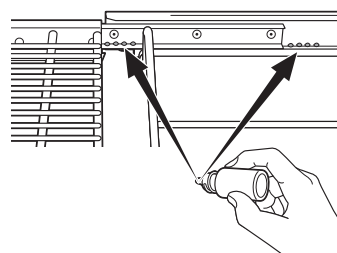
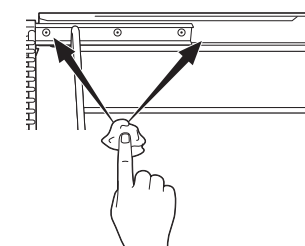
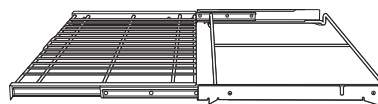

# Maintenance

## Oven Light Replacement

### ⚠ WARNING

**SHOCK OR BURN HAZARD:** Before replacing oven light bulb, disconnect the electrical power to the oven at the main fuse or circuit breaker panel. Failure to do so may result in electric shock or burn.

### ⚠ CAUTION

**BURN HAZARD:** The glass cover and bulb should be removed when cool. Touching hot glass with bare hands or a damp cloth can cause burns.

1. Disconnect power at the main fuse or circuit breaker panel.
2. Remove oven racks.
3. Slide a flat blade screwdriver between the housing and the glass light cover.
4. Support the glass light cover with two fingers to prevent the cover from falling to the bottom of the oven. Be careful not to chip the oven coating.
5. Gently twist the screwdriver blade to loosen the glass light cover.
6. Remove the glass light cover.
7. Remove the bulb by firmly grasping and sliding the bulb straight out until the two prongs have cleared the ceramic holder.
8. Do not touch the glass of the new replacement bulb with your fingers. It will cause the bulb to fail when it lights. Grasp the replacement bulb with a clean towel or facial tissue with the prongs facing down. Align the two prongs in the ceramic holder, pressing gently until the bulb is securely in the ceramic socket.
9. Slide the protective lens into the holder and push until the clips snap into the housing.
10. Reconnect power.

## Lift-Off Oven Door

The door is very heavy. Be careful when removing and lifting the door.

Do not lift the door by the handle.

### To remove the door:

1. Fully open the door.
2. Pull the hinge locks down toward the door frame, to the unlocked position. A tool, such as a small flat-blade screwdriver, may be required.
3. Firmly grasp both sides of the door at the top.
4. Close door to the door removal position. The door should be open approximately 3" with no obstruction above the door.
5. Lift door up and out until both hinge arms are clear of the slots.

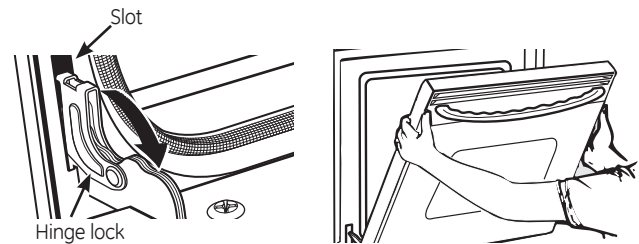

Pull hinge locks down to unlock

Removal position

### To replace the door:

1. Firmly grasp both sides of the door at the top.
2. Starting on the left side, with the door at the same angle as the removal position, seat the indentation of the hinge arm into the bottom edge of the hinge slot. The notch in the hinge arm must be fully seated into the bottom of the slot. Repeat for right side.
3. Fully open the door. If the door will not fully open, the indentation is not seated correctly in the bottom edge of the slot.
4. Push the hinge locks up against the front frame of the oven cavity, to the locked position.
5. Close the oven door.

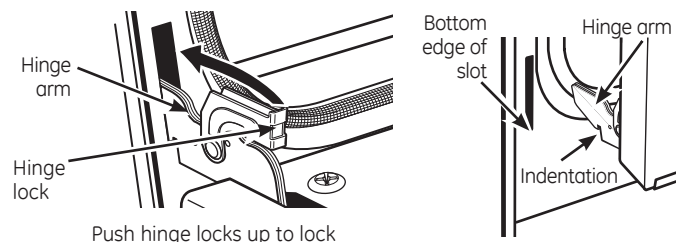

Push hinge locks up to lock

# Notes

---

# Notes

---

## Troubleshooting tips ... Before you call for service

Save time and money! Review the charts on the following pages first and you may not need to call for service.

Problem	Possible Cause	What To Do
My new oven doesn't cook like my old one. Is something wrong with the temperature settings?	Your new oven has a different cooking system from your old oven and therefore may cook differently than your old oven.	For the first few uses, follow your recipe times and temperatures carefully. If you still think your new oven is too hot or too cold, you can adjust the temperature yourself to meet your specific cooking preference. <b>NOTE:</b> This adjustment affects traditional bake Traditional Bake, Convection Bake and Convection Bake Multi temperatures; it will not affect Convection Roast, Traditional Broil, Convection Broil or Clean.
Food does not bake properly	Oven controls improperly set.	See the Cooking Modes section.
	Rack position is incorrect or rack is not level.	See the Cooking Modes section and Cooking Guide.
	Incorrect cookware or cookware of improper size being used.	See the Cookware section.
	Oven temperature needs adjustment.	See the Special Features section.
	Ingredient substitution	Substituting ingredients can change the recipe outcome.
Food does not broil properly	Oven controls improperly set.	Make sure you select the appropriate broil mode. <b>NOTE:</b> Convection crisp is not for broiling foods.
	Improper rack position being used.	See the Cooking Guide for rack location suggestions.
	Food being cooked in a hot pan.	Make sure cookware is cool
	Cookware not suited for broiling.	Use a pan specifically designed for broiling
	Aluminum foil used on the broiling pan and grid has not been fitted properly and slit as recommended.	If using aluminum foil conform to pan slits.
	In some areas the power (voltage) may be low.	Preheat the broil element for 10 minutes.
Oven temperature too hot or too cold	Oven temperature needs adjustment.	See the Special Features section.
Oven not work or appears not to work	A fuse in your home may be blown or the circuit breaker tripped.	Replace the fuse or reset the circuit breaker.
	Oven controls improperly set.	See the Using the Oven section.
	Oven is in Sabbath Mode	Verify, that the oven is not in Sabbath Mode. See the Special Features section.
"Crackling" or "popping" sound	This is the sound of the metal heating and cooling during both the cooking and cleaning functions.	This is normal.
Why is my range making a "clicking" noise when using my oven?	Your range has been designed to maintain a tighter control over your oven's temperature. You may hear your oven's heating elements "click" on and off more frequently than in older ovens to achieve better results during baking, broiling, convection, and self-clean cycles.	This is normal.
Clock and timer do not work	A fuse in your home may be blown or the circuit breaker tripped.	Replace the fuse or reset the circuit breaker.

# Troubleshooting tips ... Before you call for service

Problem	Possible Cause	What To Do
Oven light does not work	Light bulb is loose or defective.	Tighten or replace bulb.
	Pad operating light is broken.	Call for service.
Oven will not self-clean	The temperature is too high to set a self-clean operation.	Allow the oven to cool and reset the controls.
	Oven controls improperly set.	See the Cleaning the Oven section.
Excessive smoking during clean cycle	Excessive soil or grease.	Press the <b>Cancel/Off</b> pad. Open the windows to rid the room of smoke. Wait until the <b>LOCKED</b> light goes off. Wipe up the excess soil and reset the clean cycle.
Excessive smoking during broiling	Food too close to burner element.	Lower the rack position of the food.
Oven door will not open after a clean cycle	Oven too hot.	Allow the oven to cool below locking temperature.
Oven not clean after a clean cycle	Oven controls improperly set.	See the Cleaning the Oven section.
	Oven was heavily soiled.	Clean up heavy spillovers before starting the clean cycle. Heavily soiled ovens may need to self-clean again or for a longer period of time.
"LOCK DOOR" flashes in the display	The self-clean cycle has been selected but the door is not closed.	Close the oven door.
LOCKED light is on when you want to cook	The oven door is locked because the temperature inside the oven has not dropped below the locking temperature.	Press the <b>Cancel/Off</b> pad. Allow the oven to cool.
"F— and a number or letter" flash in the display	You have a function error code.	Press the <b>Cancel/Off</b> pad. Allow the oven to cool for one hour. Put the oven back into operation.
	If the function code repeats.	Disconnect all power to the oven for at least 30 seconds and then reconnect power. If the function error code repeats, call for service.
Display goes blank	A fuse in your home may be blown or the circuit breaker tripped.	Replace the fuse or reset the circuit breaker.
	The clock is turned off.	See the Special Features section.
	Oven is in Sabbath Mode.	Verify that the oven is not in Sabbath Mode. See the Special Features section.
Power outage, clock flashes	Power outage or surge	Reset the clock. If the oven was in use, you must reset it by pressing the <b>Cancel/Off</b> pad, setting the clock and resetting any cooking function.
"Burning" or "oily" odor emitting from the vent	This is normal in a new oven and will disappear in time.	To speed the process, set a self-clean cycle for a minimum of 3 hours. See the Cleaning the Oven section.
Strong odor	An odor from the insulation around the inside of the oven is normal for the first few times the oven is used.	This is temporary and will go away after several uses or a self-clean cycle.
Fan noise	A cooling fan may automatically turn on.	This is normal. The cooling fan will turn on to cool internal parts. It may run for up to 1-1/2 hours after the oven is turned off.
My oven door glass appears to be "tinted" or have a "rainbow" color. Is this defective?	No. The inner oven glass is coated with a heat barrier to reflect the heat back into the oven to prevent heat loss and keep the outer door cool while baking.	This is normal. Under certain light or angles, you may see this tint or rainbow color.

## Troubleshooting tips ... Before you call for service

<b>Problem</b>	<b>Possible Cause</b>	<b>What To Do</b>
Sometimes the oven takes longer to preheat to the same temperature	<b>Cookware or food in oven</b>	The cookware or food in the oven will cause the oven to take longer to preheat. Remove items to reduce preheat time.
	<b>Number of racks in oven</b>	Adding more racks to the oven will cause the oven to take longer to preheat. Remove some racks.
	<b>Different cooking modes</b>	The different cooking modes use different preheat methods to heat the oven for the specific cooking mode. Some modes will take longer than others (i.e. convection bake multi).
Oven will not work remotely	<b>Router issues, no wireless signal, etc.</b>	For assistance with oven wireless network connectivity, please call 1-800-220-6899.
	<b>Oven is not connected.</b>	