

PEB7227SL/BL

GE Profile™ Series 2.2 Cu. Ft. Built-In Sensor Microwave Oven

DIMENSIONS AND INSTALLATION INFORMATION (IN INCHES)

EXTERIOR DIMENSIONS (IN INCHES)	
W x H x D	24 1/8" x 14" x 19 3/4"

ACCESSORY TRIM KITS FOR GE MICROWAVE OVENS (AVAILABLE AT ADDITIONAL COST)

For a custom built-in appearance, these kits allow built-in installation of the microwave oven into a wall or cabinet alone and are U.L. approved for installation over a GE single electric wall oven. These kits should not be installed over a gas wall oven.

NOTE: 120V, 60-cycle, grounded power receptacle location optional on back within cabinet opening.

MODEL	COLOR	TRIM KIT	SIZE	Z	MAX. HEIGHT
PEB7227BLTS	Black Stainless	JX7227BLTS	27"	26 7/8"	18 7/8"
	Steel	JX7230BLTS	30"	29 3/4"	18 7/8"
PEB7227SLSS	Stainless Steel	JX7227SLSS	27"	26 7/8"	18 7/8"
	Slate	JX7227ELES	27"	26 7/8"	18 7/8"
	Stainless Steel	JX7230SLSS	30"	29 3/4"	18 7/8"
	Slate	JX7230ELES	30"	29 3/4"	18 7/8"

INSTALLATION INFORMATION: This information is not intended to be used for installing unit described. Before installing, consult installation instructions packed with product/kit for current dimensional data. For ADA compliance, the microwave must be installed no higher than 36 1/4".

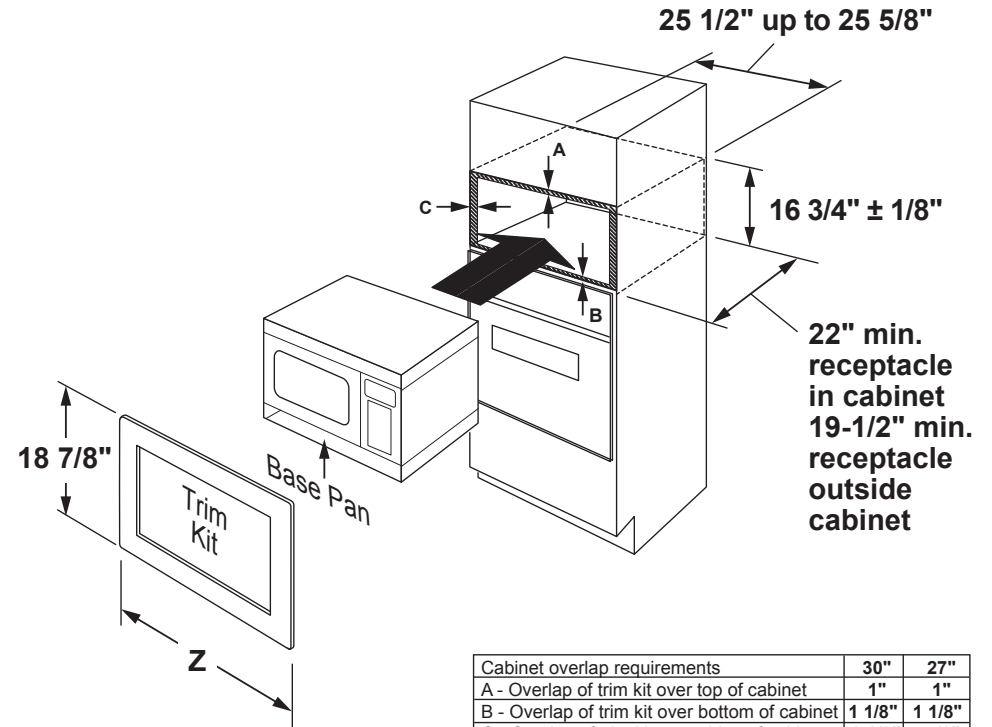

Cabinet overlap requirements	30"	27"
A - Overlap of trim kit over top of cabinet	1"	1"
B - Overlap of trim kit over bottom of cabinet	1 1/8"	1 1/8"
C - Overlap of trim kit over sides of cabinet	2 1/8"	5/8"

Note:
Allow an additional inch of clearance beyond trim frame on all sides



For answers to your Monogram, GE Café™ Series, GE Profile™ Series or GE Appliances product questions, visit our website at geappliances.com or call GE Answer Center® Service, 800.626.2000.



Specification Revised 9/17

PEB7227SL/BL

GE Profile™ Series 2.2 Cu. Ft. Built-In Sensor Microwave Oven

FEATURES AND BENEFITS

2.2 cu. ft. capacity - 1100 watts (IEC-705 test procedure)

Sensor cooking controls - Automatically adjusts time and power

Built-in trim kit - Custom appearance and built-in convenience (available at additional cost)

Weight and time defrost - Simply enter the weight of the food, and the oven automatically sets the optimal defrosting time and power level or set your desired time for defrosting

Extra-large 16.5" turntable - Rotates food throughout the cycle and accommodates large cookware

Instant on controls - One-touch instant operation

Control lockout - Helps prevent accidental activation

Add 30 seconds - Add 30 seconds of microwave cooking time

Kitchen timer - Minute timer helps keep you on track

Model PEB7227SLSS - Stainless steel

Model PEB7227BLTS - Black stainless steel

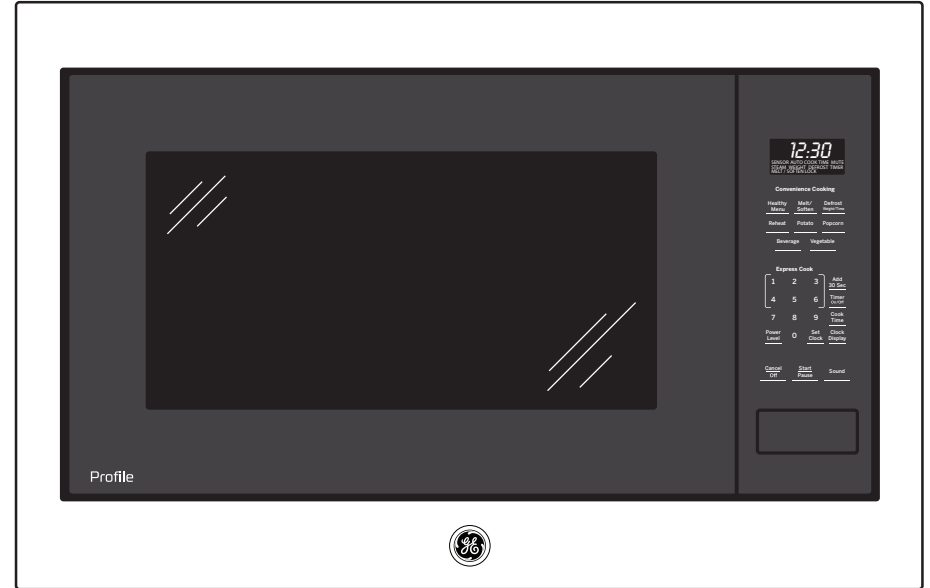

For answers to your Monogram, GE Café™ Series, GE Profile™ Series or GE Appliances product questions, visit our website at geappliances.com or call GE Answer Center® Service, 800.626.2000.



Specification Revised 9/17