

FRIGIDAIRE

All about the

Use & Care

of your Microwave Oven



TABLE OF CONTENTS

| | | | |
|------------------------------------|----|--------------------------|----|
| WELCOME & CONGRATULATION | 2 | AUTO COOKING | 16 |
| IMPORTANT SAFETY INSTRUCTIONS..... | 2 | CONVENIENT FEATURES..... | 23 |
| PART NAMES | 8 | CLEANING AND CARE..... | 26 |
| BEFORE OPERATING | 10 | SERVICE CALL CHECK | 28 |
| MANUAL COOKING..... | 11 | SPECIFICATIONS..... | 28 |
| SENSOR COOKING | 12 | WARRANTY..... | 29 |

WELCOME & CONGRATULATIONS

Questions?

1-800-944-9044

(United States)

1-800-265-8352

(Canada)

Please attach sales receipt here for future reference.

Congratulations on your purchase of a new microwave oven! At **Electrolux Home Products**, we are very proud of our product and are completely committed to providing you with the best service possible. Your satisfaction is our number one priority.

We know you'll enjoy your new microwave oven and **Thank You** for choosing our product. We hope you consider us for future purchases.

PLEASE CAREFULLY READ AND SAVE THESE INSTRUCTIONS

This Use & Care Manual provides specific operating instructions for your model. Use your microwave oven only as instructed in this manual. These instructions are not meant to cover every possible condition and situation that may occur. Common sense and caution must be practiced when installing, operating and maintaining any appliance.

Please record your model and serial numbers below for future reference.

Model Number: _____

Serial Number: _____

Purchase Date: _____

NEED HELP?

Visit the Frigidaire Web Site at: <http://www.frigidaire.com>

Before you call for service, there are a few things you can do to help us serve you better.

Read this manual.

It contains instructions to help you use and maintain your microwave oven properly.

If you received a damaged Microwave Oven... immediately contact the dealer (or builder) that sold you the Microwave Oven.

Save time and money.

Check the section titled "Service Call Check". This section helps you solve common problems that might occur. If you do need service, you can relax knowing help is only a phone call away. A list of toll-free customer service numbers is included in the back of this manual. Or call Frigidaire Customer Services at 1-800-944-9044, 24 hours a day, 7 days a week.

IMPORTANT SAFETY INSTRUCTIONS

For your safety the information in this manual must be followed to minimize the risk of fire or explosion or to prevent property damage, personal injury or loss of life.

PRECAUTIONS TO AVOID POSSIBLE EXPOSURE TO EXCESSIVE MICROWAVE ENERGY

- (a) Do not attempt to operate this oven with the door open since open-door operation can result in harmful exposure to microwave energy. It is important not to defeat or tamper with the safety interlocks.
- (b) Do not place any object between the oven front face and the door or allow soil or cleaner residue to accumulate on sealing surfaces.
- (c) Do not operate the oven if it is damaged. It is particularly important that the oven door close properly and that there is no damage to the: (1) door (bent), (2) hinges and latches (broken or loosened), (3) door seals and sealing surfaces.
- (d) The oven should not be adjusted or repaired by anyone except properly qualified service personnel.

IMPORTANT SAFETY INSTRUCTIONS

Definitions

 This is the safety alert symbol. It is used to alert you to potential personal injury hazards. Obey all safety messages that follow this symbol to avoid possible injury or death.

WARNING

WARNING indicates a potentially hazardous situation which, if not avoided, could result in death or serious injury.

CAUTION

CAUTION indicates a potentially hazardous situation which, if not avoided, may result in minor or moderate injury.

READ ALL INFORMATION BEFORE USING

WARNING

To reduce the risk of fire, burns, electric shock, injury to persons, or exposure to excessive microwave energy when using your appliance, follow basic **precautions, including the following sections.**

- Read all instructions before using the appliance.
 - Read and follow the specific **"PRECAUTIONS TO AVOID POSSIBLE EXPOSURE TO EXCESSIVE MICROWAVE ENERGY"** on page 2.
 - This appliance must be grounded. Connect only to properly grounded outlet. See **"GROUNDING INSTRUCTIONS"** on page 4.
 - Install or locate this appliance only in accordance with the provided installation instructions.
 - Some products such as whole eggs and sealed containers—for example, closed glass jars—are able to explode and should not be heated in this microwave oven.
 - Use this appliance only for its intended use as described in this manual. Do not use corrosive chemicals or vapors in this appliance. This type of microwave oven is specifically designed to heat, cook or dry food. It is not designed for industrial or laboratory use.
 - As with any appliance, close supervision is necessary when used by children.
 - Do not operate this appliance if it has a damaged cord or plug, if it is not working properly or if it has been damaged or dropped.
 - This appliance should be serviced only by qualified service personnel. Contact nearest Electrolux Authorized Servicer for examination, repair or adjustment.
 - Do not cover or block any openings on the appliance.
 - Do not store or use this appliance outdoors. Do not use this product near water—for example, near a kitchen sink, in a wet basement or near a swimming pool, or similar locations.
 - Do not immerse cord or plug in water.
 - Keep cord away from heated surfaces.
 - Do not let cord hang over edge of table or counter.
 - See door surface cleaning instructions on page 26.
 - Do not mount over a sink.
- Do not store anything directly on top of the appliance surface when the appliance is in operation.
 - To reduce the risk of fire in the microwave oven cavity:
 - **Do not overcook food. Carefully attend appliance when paper, plastic or other combustible materials are placed inside the microwave oven to facilitate cooking.**
 - Remove wire twist-ties from paper or plastic bags before placing bag in microwave oven.
 - **If materials inside the microwave oven ignite, keep microwave oven door closed, turn microwave oven off and disconnect the power cord or shut off power at the fuse or circuit breaker panel.**
 - Do not use the cavity for storage purposes. Do not leave paper products, cooking utensils or food in the cavity when not in use.
 - Liquids, such as water, coffee or tea are able to be overheated beyond the boiling point without appearing to be boiling. Visible bubbling or boiling when the container is removed from the microwave oven is not always present. **THIS COULD RESULT IN VERY HOT LIQUIDS SUDDENLY BOILING OVER WHEN A SPOON OR OTHER UTENSIL IS INSERTED INTO THE LIQUID.**
To reduce the risk of injury to persons:
 - Do not overheat the liquid.
 - Stir the liquid both before and halfway through heating it.
 - Do not use straight-sided containers with narrow necks. Use a wide-mouthed container.
 - After heating, allow the container to stand in the microwave oven at least for 20 seconds before removing the container.
 - Use extreme care when inserting a spoon or other utensil into the container.
 - Clean ventilation openings and grease filters frequently. Grease should not be allowed to accumulate on ventilation openings, louver or grease filters.
 - Use care when cleaning the louver and the grease filters. Corrosive cleaning agents, such as lye-based oven cleaners, may damage the louver and the grease filters.
 - When flaming food under the hood, turn the fan on.
 - This appliance is suitable for use above both gas and electric cooking equipment 36" wide or less.

SAVE THESE INSTRUCTIONS.

IMPORTANT SAFETY INSTRUCTIONS

UNPACKING AND EXAMINING YOUR MICROWAVE OVEN

Open the bottom of the carton, bend the carton flaps back and tilt the microwave oven over to rest on plastic foam pad. Lift carton off microwave oven and remove all packing materials, Installation Instructions, Wall Template, Top Template, Charcoal Filter, Turntable and Turntable Support. **SAVE THE CARTON AS IT MAY MAKE INSTALLATION EASIER.**

- Remove the feature sticker from the outside of the door, if there is one.
- **DO NOT REMOVE THE WAVEGUIDE COVER**, which is located on the ceiling in the microwave oven cavity. Check to see that there are Installation Instructions, Wall Template, Top Template and Charcoal Filter, which is used when recirculating is chosen. Read enclosures and **SAVE** the Use and Care Manual.

Check the microwave oven for any damage, such as misaligned or bent door, damaged door seals and sealing surfaces, broken or loose door hinges and latches and dents inside the cavity or on the door. If there is any damage, do not operate the microwave oven and contact your dealer or **ELECTROLUX SERVICER**. See Installation Instructions for more details.

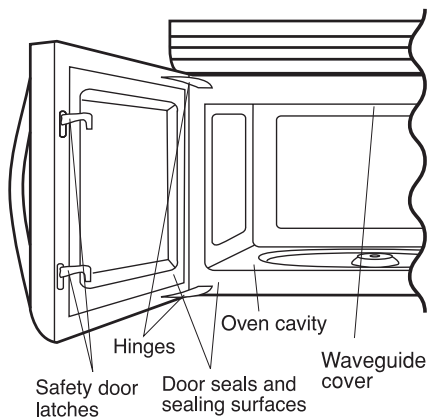

GROUNDING INSTRUCTIONS

This appliance must be grounded. This microwave oven is equipped with a cord having a grounding wire with a grounding plug. It must be plugged into a wall receptacle that is properly installed and grounded in accordance with the National Electrical Code and local codes and ordinances. In the event of an electrical short circuit, grounding reduces risk of electric shock by providing an escape wire for the electric current.



WARNING

Improper use of the grounding plug can result in a risk of electric shock.

Electrical Requirements

Check Installation Instructions for proper location for the power supply.

The electrical requirements are a 120 volt 60 Hz, AC only, 15 amp. or more protected electrical supply. It is recommended that a separate circuit serving only the microwave oven be provided.

The microwave oven is equipped with a 3-prong grounding plug. It must be plugged into a wall receptacle that is properly installed and grounded. **DO NOT UNDER ANY CIRCUMSTANCES CUT OR REMOVE THE GROUNDING PIN FROM THE PLUG. DO NOT USE AN EXTENSION CORD.**

If the power supply cord is too short, have a qualified electrician or serviceman install an outlet near the appliance.

The Power Supply Cord and plug must be connected to a separate 120 Volt AC, 60 Hz, 15 Amp, or more branch circuit, single grounded receptacle. The receptacle should be located inside the cabinet directly above the Microwave Oven mounting location as shown in Figure 1.



NOTES

1. If you have any questions about the grounding or electrical instructions, consult a qualified electrician or service person.
2. Neither Electrolux nor the dealer can accept any liability for damage to the microwave oven or personal injury resulting from failure to observe the correct electrical connection procedures.

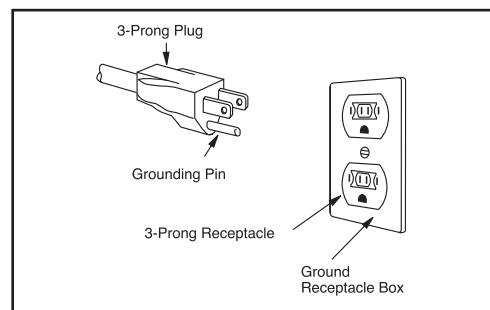
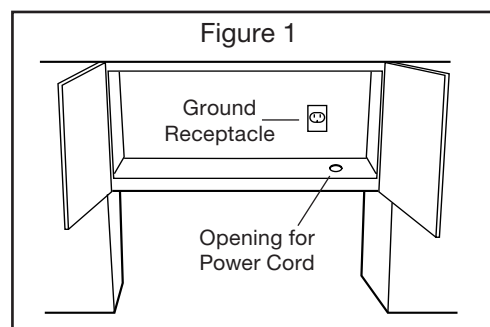

Figure 1



IMPORTANT SAFETY INSTRUCTIONS

Federal Communications Commission Radio Frequency Interference Statement (U.S.A. Only)

This equipment generates and uses ISM frequency energy and if not installed and used properly, that is in strict accordance with the manufacturer's instructions, may cause interference to radio and television reception. It has been type tested and found to comply with limits for ISM Equipment pursuant to part 18 of FCC Rules, which are designed to provide reasonable protection against such interference in a residential installation.

However, there is no guarantee that interference will not occur in a particular installation. If this equipment does cause interference to radio or television reception, which can be determined by turning the equipment off and on, the user is encouraged to try to correct the interference by one or more of the following:

- Reorient the receiving antenna of the radio or television.
- Relocate the microwave oven with respect to the receiver.
- Move the microwave oven away from the receiver.
- Plug the microwave oven into a different outlet so that the microwave oven and the receiver are on different branch circuits.

The manufacturer is not responsible for any radio or television interference caused by **unauthorized modification** to this microwave oven. It is the responsibility of the user to correct such interference.

IMPORTANT SAFETY INSTRUCTIONS

ABOUT YOUR MICROWAVE OVEN

This Use and Care Manual is valuable: read it carefully and always save it for reference.

A good microwave cookbook is a valuable asset. Check it for microwave cooking principles, techniques, hints and recipes.

NEVER use the microwave oven without the turntable and support nor turn the turntable over so that a large dish could be placed in the microwave oven. The turntable will turn both clockwise and counterclockwise. See page 26 for complete instructions.

ALWAYS have food in the microwave oven when it is on to absorb the microwave energy.

When using the microwave oven at power levels below 100%, you may hear the magnetron cycling on and off. It is normal for the exterior of the microwave oven to be warm to the touch when cooking or reheating.

Condensation is a normal part of microwave cooking. Room humidity and the moisture in food will influence the amount of moisture that condenses in the microwave oven. Generally, covered foods will not cause as much condensation as uncovered ones. Ventilation openings must not be blocked.

The microwave oven is for food preparation only. It should not be used to dry clothes or newspapers.

Your microwave oven is rated 1000 watts by using the IEC Test Procedure. In using recipes or package directions, check food a minute or two before the minimum time and add time accordingly.

ABOUT MICROWAVE COOKING

- Arrange food carefully. Place thickest areas towards outside of dish.
- Watch cooking time. Cook for the shortest amount of time indicated and add more as needed. Food severely overcooked can smoke or ignite.
- Cover foods while cooking. Check recipe or cookbook for suggestions: paper towels, wax paper, microwave plastic wrap or a lid. Covers prevent spattering and help foods to cook evenly.
- Shield with small flat pieces of aluminum foil any thin areas of meat or poultry to prevent overcooking before dense, thick areas are cooked thoroughly.
- Stir foods from outside to center of dish once or twice during cooking, if possible.
- Turn foods over once during microwaving to speed cooking of such foods as chicken and hamburgers. Large items like roasts must be turned over at least once.
- Rearrange foods such as meatballs halfway through cooking both from top to bottom and from the center of the dish to the outside.
- Add standing time. Remove food from microwave oven and stir, if possible. Cover for standing time which allows the food to finish cooking without overcooking.
- Check for doneness. Look for signs indicating that cooking temperatures have been reached.

Doneness signs include:

- Food steams throughout, not just at edge.
- Center bottom of dish is very hot to the touch.
- Poultry thigh joints move easily.
- Meat and poultry show no pinkness.
- Fish is opaque and flakes easily with a fork.

ABOUT FOOD

| FOOD | DO | DON'T |
|--|---|---|
| Eggs, sausages, nuts, seeds, fruits & vegetables | <ul style="list-style-type: none"> • Puncture egg yolks before cooking to prevent "explosion". • Pierce skins of potatoes, apples, squash, hot dogs and sausages so that steam escapes. | <ul style="list-style-type: none"> • Cook eggs in shells. • Reheat whole eggs. • Dry nuts or seeds in shells. |
| Popcorn | <ul style="list-style-type: none"> • Use specially bagged popcorn for microwave cooking. • Listen while popping corn for the popping to slow to 1 or 2 seconds or use special popcorn pad. | <ul style="list-style-type: none"> • Pop popcorn in regular brown bags or glass bowls. • Exceed maximum time on popcorn package. |
| Baby food | <ul style="list-style-type: none"> • Transfer baby food to small dish and heat carefully, stirring often. Check temperature before serving. • Put nipples on bottles after heating and shake thoroughly. "Wrist" test before feeding. | <ul style="list-style-type: none"> • Heat disposable bottles. • Heat bottles with nipples on. • Heat baby food in original jars. |
| General | <ul style="list-style-type: none"> • Cut baked goods with filling after heating to release steam and avoid burns. • Stir liquids briskly before and after heating to avoid "eruption". • Use deep bowl, when cooking liquids or cereals, to prevent boilovers. | <ul style="list-style-type: none"> • Heat or cook in closed glass jars or air tight containers. • Can in the microwave as harmful bacteria may not be destroyed. • Deep fat fry. • Dry wood, gourds, herbs or wet papers. |

IMPORTANT SAFETY INSTRUCTIONS

ABOUT UTENSILS AND COVERINGS

It is not necessary to buy all new cookware. Many pieces already in your kitchen can be used successfully in your new microwave oven. Make sure the utensil does not touch the interior walls during cooking.

Use these utensils for safe microwave cooking and reheating:

- glass ceramic (Pyroceram®), such as Corningware®.
- heat-resistant glass (Pyrex®)
- microwave-safe plastics
- paper plates
- microwave-safe pottery, stoneware and porcelain
- browning dish (Do not exceed recommended preheating time. Follow manufacturer's directions.)

These items can be used for short time reheating of foods that have little fat or sugar in them:

- wood, straw, wicker

DO NOT USE

- metal pans and bakeware
- dishes with metallic trim
- non-heat-resistant glass
- non-microwave-safe plastics (margarine tubs)
- recycled paper products
- brown paper bags
- food storage bags
- metal twist-ties

Should you wish to check if a dish is safe for microwaving, place the empty dish in the microwave oven and microwave on HIGH for 30 seconds. A dish which becomes very hot should not be used.

The following coverings are ideal:

- Paper towels are good for covering foods for reheating and absorbing fat while cooking bacon.
- Wax paper can be used for cooking and reheating.
- Plastic wrap that is specially marked for microwave use can be used for cooking and reheating. DO NOT allow plastic wrap to touch food. Vent so steam can escape.
- Lids that are microwave-safe are a good choice because heat is kept near the food to hasten cooking.
- Microwave oven cooking bags are good for large meats or foods that need tenderizing. DO NOT use metal twist ties. Remember to slit bag so steam can escape.

How to use aluminum foil in your microwave oven:

- Small flat pieces of aluminum foil placed smoothly on the food can be used to shield areas that are either defrosting or cooking too quickly.
- Foil should not come closer than one inch to any surface of the microwave oven.

Should you have questions about utensils or coverings, check a good microwave cookbook or follow recipe suggestions.

ACCESSORIES There are many microwave accessories available for purchase. Evaluate carefully before you purchase so that they meet your needs. A microwave-safe thermometer will assist you in determining correct doneness and assure you that foods have been cooked to safe temperatures. Electrolux is not responsible for any damage to the microwave oven when accessories are used.

ABOUT CHILDREN AND THE MICROWAVE

Children below the age of 7 should use the microwave oven with a supervising person very near to them. Between the ages of 7 and 12, the supervising person should be in the same room.

As with any appliance, close supervision by an adult is necessary when used by children.

At no time should anyone be allowed to lean or swing on the microwave oven door.

Children should be taught all safety precautions: use potholders, remove coverings carefully, pay special attention to packages that crisp food because they may be extra hot.

Don't assume that because a child has mastered one cooking skill he/she can cook everything.

Children need to learn that the microwave oven is not a toy. See page 23 for Child Lock feature.

ABOUT SAFETY

- Check foods to see that they are cooked to the United States Department of Agriculture's recommended temperatures.

| TEMP | FOOD |
|-----------------|--|
| 145°F (63°C) | - For beef, lamb or veal cut into steaks, chops or roasts, fish |
| 160°F (71°C) | - For fresh pork, ground meat, seafood, egg dishes, frozen prepared food and beef, lamb or veal cut into steaks, chops or roasts |
| 165°F (74°C) | - For leftover, ready-to-reheat refrigerated, deli and carry out "fresh" food, whole chicken or turkey, chicken or turkey breasts and ground poultry used in chicken or turkey burgers |

NOTE

Do not cook whole, stuffed poultry. Cook stuffing separately to 165°F.

To test for doneness, insert a meat thermometer in a thick or dense area away from fat or bone. NEVER leave the thermometer in the food during cooking, unless it is approved for microwave oven use.

- ALWAYS use potholders to prevent burns when handling utensils that are in contact with hot food. Enough heat from the food can transfer through utensils to cause skin burns.
- Avoid steam burns by directing steam away from the face and hands. Slowly lift the farthest edge of a dish's covering and carefully open popcorn and oven cooking bags away from the face.
- Stay near the microwave oven while it's in use and check cooking progress frequently so that there is no chance of overcooking food.
- NEVER use the cavity for storing cookbooks or other items.
- Select, store and handle food carefully to preserve its high quality and minimize the spread of foodborne bacteria.
- Keep waveguide cover clean. Food residue can cause arcing and/or fires.
- Use care when removing items from the microwave oven so that the utensil, your clothes or accessories do not touch the safety door latches.
- Keep aluminum foil used for shielding at least 1 inch away from walls, ceiling and door.

PART NAMES

FRONT VIEW

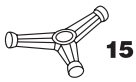
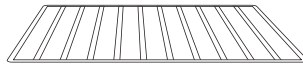
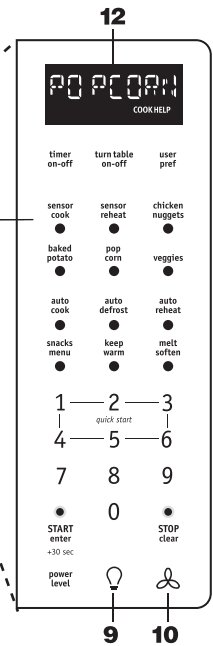
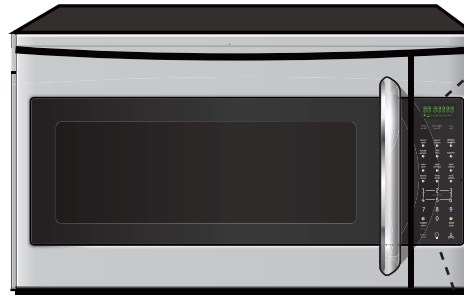
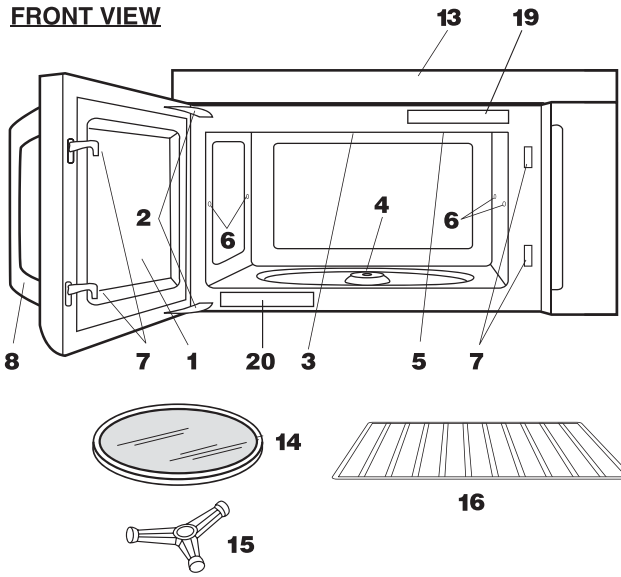

16

BOTTOM VIEW

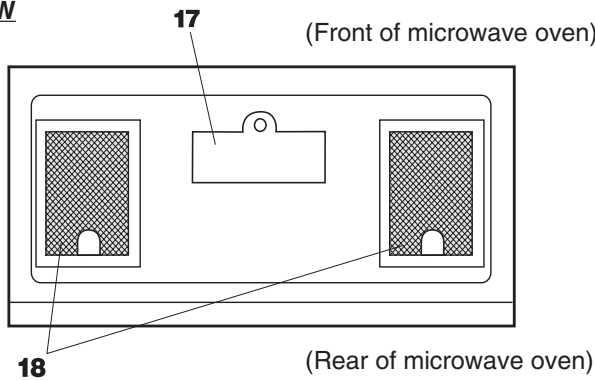

- | | |
|--|---|
| <ul style="list-style-type: none"> 1 Microwave oven door with see-through window 2 Door hinges 3 Waveguide cover: DO NOT REMOVE. 4 Turntable motor shaft 5 Microwave oven light It will light when microwave oven is operating or door is open. 6 Rack holders 7 Safety door latches The microwave oven will not operate unless the door is securely closed. 8 Handle 9 Light hi/lo/off pad Press the light hi/lo/off pad once for high, twice for low and three times to turn off the light. 10 Vent hi/lo/off pad Press the vent hi/lo/off pad once for high speed, twice for low speed and three times to turn off the fan. | <ul style="list-style-type: none"> 11 Control panel 12 Time display: Digital display, 99 minutes, 99 seconds 13 Ventilation openings 14 Removable turntable The turntable will rotate clockwise or counterclockwise. Only remove for cleaning. 15 Removable turntable support First, carefully place the turntable support in the motor shaft in the center of the microwave oven floor. Then, place the turntable on the turntable support securely. 16 Rack for 2-level cooking/ reheating 17 Light cover 18 Grease filters 19 Menu label 20 Rating label (model and serial number) |
|--|---|

CONTROL PANEL

Words in the lower portion of the display will light to indicate what function is in progress.

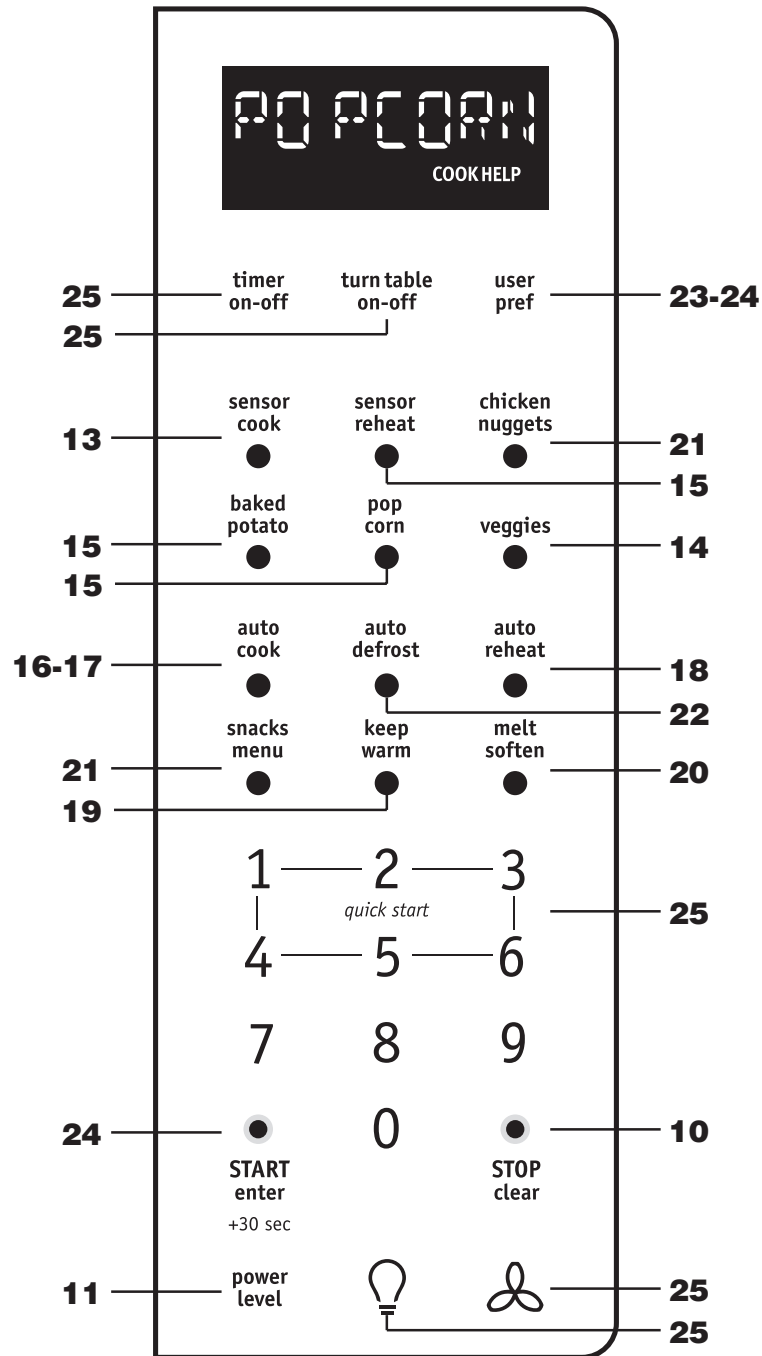

Number next to the control panel illustration indicates pages on which there are feature descriptions and usage information.

NOTE





When a pad is pressed, an audible signal will be heard which confirms the pad has been pressed.

BEFORE OPERATING

- Before operating your new oven make sure you read and understand this Use and Care Guide completely.
- Before the Over the Range Microwave Oven can be used, follow these procedures:
 1. Plug in the oven. Close the door. The oven display will show *ENJOY YOUR OVEN PRESS CLEAR*.
 2. Press the **STOP clear** pad. will appear.
 3. Set clock. See below.

To Set the Clock

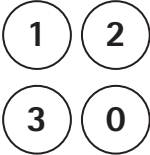
- Suppose you want to enter the correct time of day 12:30 (A.M or P.M.).

| Step | Press |
|---|---|
| 1. Press the user pref pad. |  |
| 2. Press number 5. |  |
| 3. Enter the correct time of day by pressing the numbers in sequence. |  |
| 4. Press the START enter +30 sec pad. |  |

This is a 12 hour clock. If you attempt to enter an incorrect clock time, *ERROR* will appear in the display. Press the **STOP clear** pad and re-set the clock.

- If the electrical power supply to your microwave oven should be interrupted, the display will intermittently show after the power is reinstated. If this occurs during cooking, the program will be erased. The time of day will also be erased. Simply press **STOP clear** pad and reset the clock for the correct time of day.

NOTE

Your Over the Range Microwave Oven can be programmed with the door open except for **+30 sec, Popcorn, Veggies, Baked Potato and Sensor Reheat.**

STOP clear

Press the **STOP clear** to:



1. Erase if you make a mistake during programming.
2. Cancel timer.
3. Stop the oven temporarily during cooking.
4. Return the time of day to the display.
5. Cancel a program during cooking, press twice.

MANUAL COOKING

Time Cooking

Your Over the Range Microwave Oven can be programmed for 99 minutes 99 seconds (99.99). Always enter the seconds after the minutes, even if they are both zeros.

- Suppose you want to cook for 5 minutes at 100%.

| Step | Press |
|--|---|
| 1. Enter cooking time. |  |
| 2. Press the START enter +30 sec pad. |  |



To Set Power Level

There are eleven preset power levels.

Using lower power levels increases the cooking time which is recommended for foods such as cheese, milk and long slow cooking of meats. Consult cookbook or recipes for specific recommendations.

| PRESS POWER LEVEL PAD NUMBER OF TIMES FOR DESIRED POWER | APPROXIMATE PERCENTAGE OF POWER | COMMON WORDS FOR POWER LEVELS |
|---|---------------------------------|-------------------------------|
| POWER LEVEL x 1 | 100% | High |
| POWER LEVEL x 2 | 90% | |
| POWER LEVEL x 3 | 80% | |
| POWER LEVEL x 4 | 70% | Medium High |
| POWER LEVEL x 5 | 60% | |
| POWER LEVEL x 6 | 50% | Medium |
| POWER LEVEL x 7 | 40% | |
| POWER LEVEL x 8 | 30% | Med Low/Defrost |
| POWER LEVEL x 9 | 20% | |
| POWER LEVEL x 10 | 10% | Low |
| POWER LEVEL x 11 | 0% | |

- Suppose you want to defrost for 5 minutes at 30%.

| Step | Press |
|--|---|
| 1. Enter defrosting time. |  |
| 2. Press the power level pad eight times to enter a power level of 30%. |  x 8 |
| 3. Press the START enter +30 sec pad. |  |

When the defrost time is complete, cooking completion signal will beep and END will appear in the display.

Using the Rack

The rack allows several foods to be cooked or reheated at one time. However, for the best cooking and reheating, use Turntable ON function and cook with SENSOR COOKING or AUTO COOKING without the rack. When the rack is used, set time and power level manually. Allow plenty of space around and between the dishes. Pay close attention to the cooking and reheating progress. Reposition the foods and reverse them from the rack to turntable and/or stir them at least once during any cooking or reheating time. After cooking or reheating, stir if possible. Using a lower power level will assist in better cooking and reheating uniformity.

Avoid:

- Storing the rack in the microwave oven when not in use.
- Popping popcorn with the rack in the microwave oven.
- Using any browning dish on the rack.
- Using SENSOR COOKING and AUTO COOKING with the rack.
- Cooking directly on the rack—use microwave-safe cookware.

NOTE

Turntable on/off function can be used in Manual Operation. See page 25.

MANUAL COOKING

Manual Defrost

If the food that you wish to defrost is not listed on the Defrost chart or is above or below the limits in the Amount column on the Defrost chart (see page 22), you need to defrost manually.

You can defrost any frozen food, either raw or previously cooked, by using power level for 30%. Follow the exact 3-step procedure found under To set power level. Estimate defrosting time and press **power level** pad eight times for 30% power.

For either raw or previously cooked frozen food the rule of thumb is approximately 4 minutes per pound. For example,

defrost 4 minutes for 1 pound of frozen spaghetti sauce.

Always stop the oven periodically to remove or separate the portions that are defrosted. If food is not defrosted at the end of the estimated defrosting time, program the oven in 1 minute increments on power level 30% until totally defrosted.

When using plastic containers from the freezer, defrost only long enough to remove from the plastic in order to place in a microwave-safe dish.

SENSOR COOKING

Sensor cooking has an electronic controlled sensor that detects the vapor (moisture and humidity) emitted from the food as it heats. The sensor adjusts the cooking times and power level for various foods and quantities automatically.

Using Sensor Settings:

1. After oven is plugged in, wait 2 minutes before using Sensor Settings.
2. Be sure the exterior of the cooking container and the interior of the oven are dry. Wipe off any moisture with a dry cloth or paper towel.
3. The oven works with foods at normal storage temperature. For example, popcorn would be at room temperature.
4. Any Sensor Settings selection can be programmed with More or Less Time Adjustment. See page 24.
5. More or less food than the quantity listed in the chart should be cooked following the guidelines in any microwave cookbook.
6. During the first part of SENSOR COOKING, food name will appear on the display. Do not open the oven door or press the **STOP clear** pad during this part of the cycle. The measurement of vapor will be interrupted. If this occurs, an error message will appear. To continue cooking, press the **STOP clear** pad and cook manually.

When the sensor detects the vapor emitted from the food, remainder of cooking time will appear. Door may be opened when remaining cooking time appears on the display. At this time, you may stir or season food, as desired.

7. If the sensor does not detect vapor properly when popping popcorn, the oven will turn off, and the correct time of day will be displayed. If the sensor does not detect vapor properly when cooking other foods, *ERROR* will be displayed, and the oven will turn off.
8. Check food for temperature after cooking. If additional time is needed, continue to cook manually.
9. Each food has a cooking hint. Press the **user pref** pad when the *HELP* indicator is lighted in the display.

Covering Foods:

Some foods cook better when covered. Use the cover recommended in the food charts.

1. Casserole lid.
2. Plastic wrap: Use plastic wrap recommended for microwave cooking. Cover dish loosely; allow approximately 1/2 inch to remain uncovered to allow steam to escape. Plastic wrap should not touch food.
3. Wax paper: Cover dish completely; fold excess wrap under dish to secure. If dish is wider than paper, overlap two pieces at least one inch to cover.

Be careful when removing any covering to allow steam to escape away from you.

SENSOR COOKING

SENSOR COOKING applies to the following selections: Sensor Cook, Popcorn, Veggies, Baked Potato, Sensor Reheat

NOTES for SENSOR COOKING



1. SENSOR MODES can be programmed with More or Less Time Adjustment. Press the **power level** pad once or twice before cooking is started. See page 24.
2. Each food has a cooking hint. Press the **user pref** pad when the *HELP* indicator is lighted in the display.
3. Should you attempt to enter more or less than the allowed amount, an error message will appear in the display. More or less than the quantity listed in the chart should be cooked following the guidelines in any microwave cookbook.
4. The final cooking result will vary according to the food condition (e.g. initial temperature, shape, quality). Check food for temperature after cooking. If additional time is needed, continue to cook manually.
5. When sensor detects the vapor emitted from the foods, manipulation message or remaining cooking time will be displayed.
6. Stay near the oven while it's in use and check cooking progress frequently so that there is no chance of overcooking food.
7. When SENSOR COOKING are selected Turntable On is automatically set for optimum cooking.

Sensor Cook

There are 5 foods (Frozen Entrees, Ground Meat, Rice, Fish/Seafood, and Chicken Breast) under the SENSOR COOK that uses the sensor.

You can cook many foods by pressing the **sensor cook** pad and the food number. You don't need to calculate cooking time or power level.

- Suppose you want to cook Frozen Entrees.

| Step | Press |
|---|---|
| 1. Press the sensor cook pad, number 1 for Frozen Entrees. |   |
| 2. At end, follow the directions in the display. | |
| 3. Press the START enter +30 sec pad. |  |

Sensor Cook chart



| FOOD | AMOUNT | PROCEDURE | | | | | | | | | | | | | | | |
|--------------------|-------------------------------|--|------|-------|------------------------|--------|-------|-----------|-------|--------|---------|----------|--------|----------------|--------|--------|-------------------|
| 1. Frozen Entrees* | 6 - 17 oz 170 - 480 g | Use this pad for frozen, convenience foods. It will give satisfactory results for most brands. You may wish to try several and choose your favorite. Remove package from outer wrapping and follow package directions for covering. After cooking, let stand, covered for 1 to 3 minutes. | | | | | | | | | | | | | | | |
| 2. Ground Meat* | 0.25 - 2.0 lb 0.2 - 0.9 kg | Use this setting to cook ground beef or turkey as patties or in a casserole to be added to other ingredients. Place patties on a microwave-safe rack and cover with wax paper. Place ground meat in a casserole and cover with wax paper or plastic wrap. When oven stops, turn patties over or stir meat in casserole to break up large pieces. Re-cover and press the START enter +30 sec pad. After cooking, let stand, covered, for 2 to 3 minutes. | | | | | | | | | | | | | | | |
| 3. Rice* | 0.5 - 2.0 cups | Place rice into a deep casserole dish and add double quantity of water. Cover with lid or plastic wrap. After cooking, stir, cover and let stand 3 to 5 minutes or until all liquid has been absorbed. <table border="1" data-bbox="544 1549 1187 1713"> <thead> <tr> <th>Rice</th> <th>Water</th> <th>Size of casserole dish</th> </tr> </thead> <tbody> <tr> <td>.5 cup</td> <td>1 cup</td> <td>1.5 quart</td> </tr> <tr> <td>1 cup</td> <td>2 cups</td> <td>2 quart</td> </tr> <tr> <td>1.5 cups</td> <td>3 cups</td> <td>2.5 or 3 quart</td> </tr> <tr> <td>2 cups</td> <td>4 cups</td> <td>3 quart or larger</td> </tr> </tbody> </table> | Rice | Water | Size of casserole dish | .5 cup | 1 cup | 1.5 quart | 1 cup | 2 cups | 2 quart | 1.5 cups | 3 cups | 2.5 or 3 quart | 2 cups | 4 cups | 3 quart or larger |
| Rice | Water | Size of casserole dish | | | | | | | | | | | | | | | |
| .5 cup | 1 cup | 1.5 quart | | | | | | | | | | | | | | | |
| 1 cup | 2 cups | 2 quart | | | | | | | | | | | | | | | |
| 1.5 cups | 3 cups | 2.5 or 3 quart | | | | | | | | | | | | | | | |
| 2 cups | 4 cups | 3 quart or larger | | | | | | | | | | | | | | | |
| 4. Fish/Seafood* | 0.25 - 2.0 lb 0.2 - 0.9 kg | Arrange in ring around shallow glass dish (roll fillet with edges underneath). Cover with plastic wrap. After cooking, let stand, covered, 3 minutes. | | | | | | | | | | | | | | | |
| 5. Chicken Breast* | 0.5 - 2.0 lb 0.3 - 0.9 kg | Cover with vented plastic wrap. When oven stops, turn over. Shield with small, flat pieces of aluminum foil any areas that are cooking too rapidly. Re-cover and press the START enter +30 sec pad. After cooking, let stand, covered 3 to 5 minutes. Chicken should be 160°F. | | | | | | | | | | | | | | | |

* It is not necessary to enter amount.

SENSOR COOKING

Popcorn

- Suppose you want to cook popcorn.

| Step | Press |
|---|---|
| <Regular> Press the popcorn pad once. |  |
| <Snack> Press the popcorn pad twice. |  x 2 |

NOTES



1. The **popcorn** pad can only be accepted within 3 minutes after cooking, opening and closing the door or pressing the **STOP clear** pad to prevent from misusing.
2. Cooking can be also started by pressing the **START enter +30 sec** pad within 2 seconds after pressing the **popcorn** pad.

Popcorn chart

| FOOD | AMOUNT | PROCEDURE |
|---------|---|---|
| Popcorn | 1 package Regular: 3.0 - 3.5 oz, 85 - 100 g Snack: 1.5 - 1.75 oz, 45 - 50 g | Use only popcorn packaged for the microwave. Try several brands to decide which you like. Do not try to pop unpopped kernels. The amount is selected by pressing the pad once (Regular) or twice (Snack). |

Veggies

- Suppose you want to cook vegetables.

| Step | Press |
|---|---|
| <Fresh Veggies Soft> Press the veggies pad once. |  |
| <Frozen Veggies Hard> Press the veggies pad twice. |  x 2 |
| <Frozen Veggies> Press the veggies pad three times. |  x 3 |

NOTES

1. The **veggies** pad can only be accepted within 3 minutes after cooking, opening and closing the door or pressing the **STOP clear** pad to prevent from misusing.
2. Cooking can be also started by pressing the **START enter +30 sec** pad within 2 seconds after pressing the **veggies** pad.

Veggies chart

| FOOD | AMOUNT | PROCEDURE |
|---------------------------|--------------------------------|---|
| 1. Fresh Vegetables, soft | 0.25 - 2.0 lb, 0.2 - 0.9 kg | Wash and place in casserole. Add no water if vegetables have just been washed. Cover with lid for tender vegetables. Use plastic wrap for tender-crisp vegetables. Press the veggies pad once. After cooking, stir, if possible. Let stand, covered, for 2 to 5 minutes. |
| Broccoli | 0.25 - 2.0 lb, 0.2 - 0.9 kg | |
| Brussels sprouts | 0.25 - 2.0 lb, 0.2 - 0.9 kg | |
| Cabbage | 0.25 - 2.0 lb, 0.2 - 0.9 kg | |
| Cauliflower (flowerets) | 0.25 - 2.0 lb, 0.2 - 0.9 kg | |
| Cauliflower (whole) | 1 medium | |
| Spinach | 0.25 - 1.0 lb, 0.2 - 0.45 kg | |
| Zucchini | 0.25 - 2.0 lb, 0.2 - 0.9 kg | |
| Baked apples | 2 - 4 medium | |
| 2. Fresh Vegetables, hard | 0.25 - 2.0 lb, 0.2 - 0.9 kg | Place in casserole. Add 1-4 tbsp. water. Cover with lid for tender vegetables. Use plastic wrap cover for tender-crisp vegetables. Press the veggies pad twice. After cooking, stir, if possible. Let stand, covered, for 2 to 5 minutes. |
| Carrots, sliced | 0.25 - 1.5 lb, 0.2 - 0.6 kg | |
| Corn on cob | 2 - 4 pcs. | |
| Green beans | 0.25 - 1.5 lb, 0.2 - 0.6 kg | |
| Winter squash | 0.25 - 1.5 lb, 0.2 - 0.6 kg | |
| - diced | 0.25 - 1.5 lb, 0.2 - 0.6 kg | |
| - halves | 1 - 2 | |
| 3. Frozen Veggies* | 0.25 - 1.25 lb 0.2 - 0.5 kg | Add no water. Cover with lid or plastic wrap. Press the veggies pad three times. After cooking, stir and let stand, covered, for 3 minutes. |

* It is not necessary to enter amount or number.

SENSOR COOKING

Baked Potato

- Suppose you want to cook 2 pieces of potatoes.

| Step | Press |
|------------------------------------|---|
| Press the baked potato pad. |  |

NOTES

1. The **baked potato** pad can only be accepted within 3 minutes after cooking, opening and closing the door or pressing the **STOP clear** pad to prevent from misusing.
2. Cooking can be also started by pressing the **START enter +30 sec** pad within 2 seconds after pressing the **baked potato** pad.

Baked Potato chart

| FOOD | AMOUNT | PROCEDURE |
|---------------|-----------------------|---|
| Baked Potato* | 1 - 8 pieces (medium) | Pierce with fork in several places. Place on paper towel on turntable. After cooking, remove from oven and let stand wrapped in foil for 5 to 10 minutes. |

* It is not necessary to enter amount or number.

Sensor Reheat

- Suppose you want to reheat soup.

| Step | Press |
|-------------------------------------|---|
| Press the sensor reheat pad. |  |

NOTES

1. The **sensor reheat** pad can only be accepted within 3 minutes after cooking, opening and closing the door or pressing the **STOP clear** pad to prevent from misusing.
2. Cooking can be also started by pressing the **START enter +30 sec** pad within 2 seconds after pressing the **sensor reheat** pad.

Sensor Reheat chart

| FOOD | AMOUNT | PROCEDURE |
|----------------|----------------------------|---|
| Sensor Reheat* | 4 - 36 oz 0.12 - 1.0 kg | Place in dish or casserole slightly larger than amount to be reheated. Flatten, if possible. Cover with lid, plastic wrap or wax paper. Use covers such as plastic wrap or lids with larger quantities of more dense foods such as stews. After reheating, stir well, if possible. Re-cover and allow to stand 2 to 3 minutes. Foods should be very hot. If not, continue to heat with variable power and time. |

* It is not necessary to enter amount or number.

AUTO COOKING

AUTO COOKING consists of 7 functions - Auto Cook, Auto Reheat, Keep Warm, Melt Soften, Snacks Menu, Chicken Nuggets and Auto Defrost.

NOTES



1. AUTO COOKING except Keep Warm can be programmed with More or Less Time Adjustment. Press the **power level** pad once or twice before cooking is started. See page 24.
2. Each food has a cooking hint except for Melt Soften. Press the **user pref** pad when the *HELP* indicator is lighted in the display for a helpful hint.

Auto Cook

Auto cook is divided into 2 parts - Quick Meals (Frozen Breakfast, Scrambled Eggs, Hot Cereal and Soup) and Dinner Recipes (Chicken and Rice, Meatloaf, Roast Pork, Seafood Pasta and Vegetarian Medley).

<Quick Meals>

- Suppose you want to cook Hot Cereal for 1 serving with Less Time Adjustment.

| Step | Press |
|---|---|
| 1. Press the auto cook pad, number 3 for hot cereal. |   |

Quick Meals chart

| FOOD | AMOUNT | PROCEDURE |
|----------------------|------------------------|---|
| 1. Frozen Breakfast* | 3 - 6 oz 85 - 170 g | This setting works well for frozen breakfast entrees, pancakes, waffles, burritos etc. Follow manufacturer's directions for how to prepare for microwaving. Allow to stand 1 or 2 minutes after cooking. |
| 2. Scrambled Eggs | 1 - 8 eggs | For each egg, use 1 teaspoon of butter or margarine and 1 tablespoon of milk. Place butter or margarine in dish, measuring cup or casserole large enough for the egg to expand. Mix egg and milk together. Pour on to butter or margarine in dish. Cover with wax paper. Place in oven and program. Press number 2 to increase quantity and press the START enter +30 sec pad. When oven stops, stir egg mixture moving the cooked portion to the center of the dish, uncooked portion to the outside, close the door and press the START enter +30 sec pad. After cooking, stir and let stand, covered, until set. Note that eggs will be slightly undercooked when removed from the oven. |
| 3. Hot Cereal | 1- 6 servings | Use individual packets or bulk cereal in your favorite variety: oatmeal, oat bran, cream of wheat, farina or wheatena. Follow package directions for the correct amount of water or milk. To prevent boilovers, it is very important to choose a large container because microwave cooking of cereal causes high boiling. Press number 3 to increase quantity and press the START enter +30 sec pad. When oven stops, stir and press the START enter +30 sec pad. After cooking, stir and let stand, covered, for 2 minutes. |
| 4. Soup | 1 - 8 cups | Place in bowl or casserole. Cover with lid or plastic wrap. Press number 4 to increase quantity and press the START enter +30 sec pad. At end, stir, recover and let stand 1 to 3 minutes. |

* It is not necessary to enter amount or number.

2. Repeat pressing same number pad at Step 1 to increase quantity.
Ex: 1 serving.



3. Press the **power level** pad twice for Less Time Adjustment.

 x 2

4. Press the **START enter +30 sec** pad.



5. Midway through the cooking, audible signals will be heard and your oven will stop. Open the door, follow the instruction shown in the display and close the door.

6. Press the **START enter +30 sec** pad to continue cooking.







NOTES

1. Skip Step 3, when More or Less Time Adjustment is not needed.
2. Scrambled Eggs, Hot Cereal and Soup are same procedure. Follow the above procedure.
3. Frozen Breakfast is not needed to enter amount or number. Skip Step 2.
4. If mute is set, the audible signals will not be heard at Step 5. See 2, Audible Signal Elimination on page 23.
5. When AUTO COOKING are selected, Turntable On is automatically set for optimum cooking.

<Dinner Recipes>

- Suppose you want to cook Chicken and Rice.

| Step | Press |
|--|---|
| 1. Press the auto cook pad, number 5 and the START enter +30 sec pad for Chicken and Rice. |    |
| 2. Midway through the cooking, audible signals will be heard and your oven will stop. Open the door, follow the instruction shown in the display and close the door. Press the START enter +30 sec pad. |  |

NOTES

1. Skip Step 2 in Roast Pork and Seafood Pasta.
2. If mute is set, the audible signals will not be heard at Step 2. See 2, Audible Signal Elimination on page 23.

<Dinner Recipes (recipes serve 6)>

5. Chicken and Rice

Place in a 3 quart casserole:

- 1 package (5 - 8 ounces) yellow rice mix with flavor packet
- 2 cups chicken broth

Stir well and cover. Press the **auto cook** pad, number 5 and press the **START enter +30 sec** pad.

At pause, stir well and add:

- 1 cup frozen peas
- 1 red pepper, diced
- 1 1/4 pounds boneless chicken cutlets, sliced into thin strips

Re-cover. Press the **START enter +30 sec** pad.

At end, garnish with parsley.

6. Meatloaf

Mix together well:

- 1 1/2 pounds lean ground beef
- 1/2 cup soft bread crumbs
- 1/2 cup red wine
- 1 egg, beaten
- 2 tablespoons chopped onion
- 1/2 teaspoon salt
- 1/2 teaspoon dry mustard
- 1/4 teaspoon pepper
- 1 teaspoon instant beef bouillon
- 2 tablespoons chopped green pepper

Place in a 9 x 5-inch glass loaf dish.

Press the **auto cook** pad, number 6 and press the **START enter +30 sec** pad.

If desired, spread top of meat loaf with 1/2 cup catsup during last 2 minutes of cooking time.

At end, remove from oven, cover with foil and allow to stand 3 to 5 minutes before serving.

7. Roast Pork

Combine in small dish:

- 1 tablespoon butter, melted
- 2 cloves garlic, minced
- 1 teaspoon dried marjoram leaves, crushed
- 1/2 teaspoon dried oregano leaves, crushed
- 1/2 teaspoon pepper

Stir well. Brush on:

- 1 (3 pound) boneless, pork loin, center cut

Place loin in a 13 x 9 x 2-inch casserole. Cover with vented plastic wrap.

Press the **auto cook** pad, number 7 and press the **START enter +30 sec** pad.

8. Seafood Pasta

Place in a 3 quart casserole:

- 8 - 9 ounces fresh tortellini
- 2 cups water

Stir well and cover. Press the **auto cook** pad, number 8 and press the **START enter +30 sec** pad.

At pause, stir well and add:

- 1 jar (17 ounces) creamy Alfredo sauce or 1 3/4 cups of medium, white cheese sauce
- 1 1/4 pounds combination raw shellfish, fresh or thawed (shrimp, bay scallops, crabmeat)
- 3 cups mixed, fresh vegetables (sliced mushrooms, thinly julienned carrots, green beans)

Re-cover. Press the **START enter +30 sec** pad.

At end, garnish with:

- 1/3 cup grated Parmesan cheese

9. Vegetarian Medley

Place in a 3 quart casserole:

- 1 cup orzo or other tiny shaped pasta
- 3 1/2 cups vegetable or chicken broth
- 1/4 cup pesto sauce (fresh or reconstituted from dry)
- 1/2 cup small pieces of sundried tomatoes
- 1 tablespoon minced garlic
- 1 tablespoon Italian seasoning

Stir well and cover. Press the **auto cook** pad, number 9 and press the **START enter +30 sec** pad.

At pause, stir well and add:

- 3 cups chopped green, red, orange or yellow peppers
- 1 onion, thinly sliced
- 1 can (14 ounces) artichoke hearts, drained and quartered
- 1 can (3 ounces) pitted, ripe olives, drained and halved

Re-cover. Press the **START enter +30 sec** pad.





At end, stir and garnish top with:

- 1/2 cup freshly shredded Parmesan cheese
- 1/4 cup pine nuts

AUTO COOKING

Auto Reheat

- Suppose you want to reheat 2 fresh muffins with auto reheat.

| Step | Press |
|---|---|
| 1. Press the auto reheat pad and number 1 for fresh muffin. |   |
| 2. Repeat pressing same number pad at Step 1 to increase quantity. Ex : 2 muffins. |  x 2 |
| 3. Press the START enter +30 sec pad. |  |



NOTES

- Auto Reheat can be programmed with More or less time adjustment. See page 24.
- Fresh rolls/muffins, frozen rolls/muffins, pasta and beverage are same procedure. Follow the left side procedure.

Auto Reheat chart

| FOOD | AMOUNT | PROCEDURE |
|-----------------------------|----------------|---|
| 1. Fresh Rolls/ Muffins | 1 - 10 pieces | Use this pad to warm rolls, muffins, biscuits, bagels etc. Large items should be considered as 2 or 3 regular size. Arrange on flat plate; cover with paper towel. For refrigerated rolls or muffins, it may be necessary to double the entered amount to ensure the proper serving temperature. For example, enter quantity of 2 for 1 refrigerated muffin. Press the auto reheat pad and number 1 to increase quantity and press the START enter +30 sec pad. |
| 2. Frozen Rolls/ Muffins | 1 - 10 pieces | Use this pad to warm rolls, muffins, biscuits, bagels etc. Large items should be considered as 2 or 3 regular size. Arrange on flat plate; cover with paper towel. Press the auto reheat pad and number 2 to increase quantity and press the START enter +30 sec pad. |
| 3. Pasta | 1 - 6 cups | Use this pad to reheat refrigerated canned or homemade pasta with sauce. For room temperature pastas, use Less option. Pasta without sauce double the quantity per setting. For example, measure 2 cups of cooked noodles and program for 1 cup. Cover with lid or plastic wrap. Press the auto reheat pad, number 3 to increase quantity and press the START enter +30 sec pad. After cooking, stir and let stand, covered 2 to 3 minues. |
| 4. Beverage | 0.5 - 2.0 cups | This setting is good for restoring a cool beverage to a better drinking temperature. Stir liquid briskly before and after heating to avoid "eruption". Press the auto reheat pad, number 4 to increase quantity and press the START enter +30 sec pad. |



AUTO COOKING

Keep Warm

Keep Warm allows you to keep food warm for 30 minutes at the maximum.

Direct use

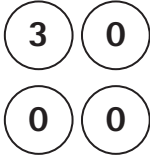



- Suppose you want to keep a cup of soup warm for 30 minutes.

| Step | Press |
|--|---|
| 1. Press the keep warm pad. |  |
| 2. Enter the desired time. Ex : 30 minutes. |  |
| 3. Press the START enter +30 sec pad. |  |

The oven will start. The display will show *30.00* and count down. *KEEP WARM* will be displayed every 10 seconds during the countdown.

With manual cooking

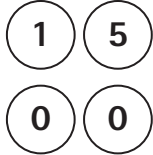
- Suppose you want to cook a cup of soup for 2 minutes at 70% and keep the soup warm for 15 minutes.

| Step | Press |
|---|--|
| 1. Enter cooking time. |  |
| 2. Press the power level pad 4 times for 70% power. |  |
| 3. Press the keep warm pad. |  |
| 4. Enter the desired time by pressing the number pads 1, 5, 0 and 0 for 15 minutes. |  |
| 5. Press the START enter +30 sec pad. |  |

The operation will start. When the cooking time is complete, cooking completion signal will sound and Keep warm will start. *KEEP WARM* will appear in the display every 10 seconds and count down for 15 minutes.

NOTES

- Keep warm cannot be programmed in conjunction with *SENSOR COOKING* or *AUTO COOKING*.
- Keep warm can be used in conjunction with sequence cooking in Auto Start function. See Auto Start on page 23.
- Turn table on/off function can be used in keep warm. See page 25.





AUTO COOKING

Melt Soften

Melt Soften automatically compute the correct heating time and microwave power level for melting and softening foods shown in the chart.

There are 4 foods (butter, chocolate, ice cream and cream cheese) under the Melt Soften.

- Suppose you want to melt 1 square of chocolate with More Time Adjustment.

| Step | Press |
|---|---|
| 1. Press the melt soften pad once, number 2 for chocolate. |   |
| 2. Repeat pressing same number pad at Step 1 to select quantity. Ex: Press number 2 two more times for 1 square. |  x 2 |
| 3. Press the START enter +30 sec pad. |  |

NOTES

1. To melt, soften other food or foods except the quantity listed in the melt, soften, use manual operation.
2. Butter, chocolate, ice cream and cream cheese are same procedure. Follow the procedure on the left side.

Melt Soften chart

| FOOD | AMOUNT | PROCEDURE |
|-----------------|-------------|---|
| Melt | | |
| 1. Butter | 2 tbsp | Use a Pyrex measuring cup. Cover with plastic wrap. Stir after cooking. After pressing the melt soften pad, press number 1 two times for 2 tbsp. |
| | 1/2 cup | After pressing the melt soften pad, press number 1 three times for 1/2 cup. |
| 2. Chocolate | 1 cup chips | After pressing the melt soften pad, press number 2 two times for 1 cup chips. |
| | 1 square | After pressing the melt soften pad, press number 2 three times for 1 square. |
| Soften | | |
| 3. Ice cream | | DO NOT COVER. |
| | 1 pint | After pressing the melt soften pad, press number 3 two times for 1 pint. |
| | 1/2 gallon | After pressing the melt soften pad, press number 3 three times for 1/2 gallon. |
| 4. Cream cheese | | Use a small plate. DO NOT COVER. |
| | 3 oz, 85 g | After pressing the melt soften pad, press number 4 two times for 3 oz or 85 g. |
| | 8 oz, 225 g | After pressing the melt soften pad, press number 4 three times for 8 oz or 225 g. |



AUTO COOKING

Snacks Menu

Snacks are for cooking/heating foods that take a short amount of time!

There are 6 foods (Frozen MW Pizza, Hand Held Snacks - small and large size, Hot Dogs, Frozen Kid's Meal and Pizza) under the Snacks Menu.

- Suppose you want to reheat a slice of pizza with snacks.

| Step | Press |
|--|--|
| 1. Press the snacks menu pad and number 6 for pizza. | snacks menu  |
| 2. Repeat pressing same number pad at Step 1 to increase quantity. |  |

| Step | Press |
|--|-------------------------------|
| 3. Press the START enter +30 sec pad. | START enter +30 sec |

NOTE

Use above steps to cook other Snack Menus listed below in chart. Frozen MW Pizza, Hand Held Snacks and Frozen Kid's Meal do not require an amount or number to be entered. Skip Step 2.

Snack Menu chart

| FOOD | AMOUNT | PROCEDURE |
|-----------------------|-------------------------|---|
| 1. Frozen MW Pizza* | 6 - 8 oz 170 - 225 g | Use for frozen microwave pizza. Remove from package and unwrap. Follow package directions for use of package and/or silver crisping disk. |
| 2. Hand Held Snacks* | 3 - 4 oz 85 - 113 g | Use for frozen French fries, cheese sticks, appetizers etc. Remove from outer package. Arrange on flat plate. Follow package directions for how to wrap or cover. Be careful when removing from the oven as snack may be very hot. |
| 3. Hand Held Snacks* | 5 - 6 oz 142 - 170 g | Use for frozen French fries, cheese sticks, appetizers etc. Remove from outer package. Arrange on flat plate. Follow package directions for how to wrap or cover. Be careful when removing from the oven as snack may be very hot. |
| 4. Hot Dogs | 1 - 6 pieces | Place hot dog in bun. Wrap each with paper towel or napkin. Press number 4 to increase quantity and press the START enter +30 sec pad. |
| 5. Frozen Kid's Meal* | 6 - 8 oz 170 - 225 g | Use this pad for frozen, convenience foods. It will give satisfactory results for most brands. You may wish to try several and choose your favorite. Remove package from outer wrapping and follow package directions for covering. After cooking, let stand, covered for 1 to 3 minutes. |
| 6. Pizza | 1 - 6 slices | Use this setting to reheat refrigerated leftover pizza, 1 slice is approximately 1/8th of a 12-inch pizza or 1/12th of a 16-inch pizza. Arrange on flat plate. Press number 6 to increase quantity and press the START enter +30 sec pad. |

* It is not necessary to enter amount.

Chicken Nuggets

- Suppose you want to heat 0.3 pound or 0.3 kilogram chicken nuggets with snacks.

| Step | Press |
|--|---|
| 1. Press the chicken nuggets pad. | chicken nuggets |
| 2. Enter amount by pressing the number 3. Ex: 0.3 lb or 0.3 kg chicken nuggets. |  |

| Step | Press |
|--|-------------------------------|
| 3. Press the START enter +30 sec pad. | START enter +30 sec |

NOTE

When 1.0 pound chicken nuggets is heated, press number 1 and 0 at Step 2.

Chicken Nuggets chart

| FOOD | AMOUNT | PROCEDURE |
|-----------------|------------------------------|---|
| Chicken Nuggets | 0.3 - 1.0 lb 0.2 - 0.4 kg | Place frozen chicken nuggets on a flat plate allowing space between each. It is not necessary to cover them. When oven stops, rearrange and press the START enter +30 sec pad. |







AUTO COOKING

Auto Defrost

There are 6 foods (Ground Meat, Stakes/Chops/Fish, Chicken Pieces, Roast, Casserole and Soup) under the Auto Defrost.

Auto Defrost automatically defrosts all the foods found in the Defrost chart below.

- Suppose you want to defrost a 1.8 pound or 1.8 kilogram steak.

| Step | Press |
|--|---|
| 1. Press the auto defrost pad and number 2 for steak. |   |
| 2. Enter weight by pressing number 1 and 8. Ex: 1.8 lb or 1.8 kg steak. |   |
| 3. Press the START enter +30 sec pad. |  |
| 4. Midway through the cooking, audible signals will be heard and your oven will stop. Open the door, follow the instruction shown in the display and close the door. Press the START enter +30 sec pad. |  |

After defrost cycle ends, let stand, covered.

Auto Defrost chart

| FOOD | AMOUNT | PROCEDURE |
|--------------------------|------------------------------|---|
| 1. Ground Meat | 0.5 - 3.0 lb 0.3 - 1.3 kg | Remove any thawed pieces after each stage. Let stand, covered, for 5 to 10 minutes. |
| 2. Steaks/Chops/ Fish | 0.5 - 4.0 lb 0.3 - 1.8 kg | After each stage, rearrange and if there are warm or thawed portions, shield with small flat pieces of aluminum foil. Remove any meat or fish that is almost defrosted. Let stand, covered, for 10 to 20 minutes. |
| 3. Chicken Pieces | 0.5 - 3.0 lb 0.3 - 1.3 kg | After each stage, rearrange pieces or remove portions should they become warm or thawed. Let stand, covered, for 10 to 20 minutes. |
| 4. Roast | 2.0 - 4.0 lb 1.0 - 1.8 kg | Start defrosting with fat side down. After each stage, turn roast over and shield the warm portions with aluminum foil. Let stand, covered, for 30 to 60 minutes. |
| 5. Casserole | 2 - 6 cups | After audible signal, stir if possible. At end, stir well and let stand, covered, for 5 to 10 minutes. |
| 6. Soup | 1 - 6 cups | After audible signal, stir if possible. At end, stir well and let stand, covered, for 5 to 10 minutes. |

NOTES

1. To defrost other food or foods above or below the weights allowed on the Defrost chart, use time and 30% power. See Manual defrost on page 12.
2. If you attempt to enter more or less than the amount as indicated in the chart below, an error message will appear in the display.
3. Check foods when your oven stops. After final stage, small sections may still be icy. Let stand to continue thawing. Do not defrost until all ice crystals are thawed.
4. If mute is set, the audible signals will not be heard at Step 4. See 2, Audible Signal Elimination on page 23.
5. Shielding prevents cooking from occurring before the center of the food is defrosted. Use small smooth strips of aluminum foil to cover edges and thinner sections of the food.
6. Press number 5 to enter 0.5 pound or 0.5 kilogram at Step 2.
7. Press desired number for casserole and soup at Step 2.

CONVENIENT FEATURES

User Pref

User Pref provides 5 features that make using your oven easy because specific instructions are provided in the interactive display.

1. Child Lock

The Child Lock prevents unwanted oven operation such as by small children. The oven can be set so that the control panel is deactivated or locked. To set, press the **user pref** pad, the number 1 and then press the **START enter +30 sec** pad. Should a pad be pressed, *LOCKED* will appear in the display.

To cancel, press the **user pref** pad and the **START enter +30 sec** pad. Child Lock will not be canceled if other pads except the **START enter +30 sec** pad are pressed after pressing the **user pref** pad.

2. Audible Signal Elimination







If you wish to have the oven operate with no audible signals, press the **user pref** pad, number 2 and the **STOP clear** pad.











To cancel and restore the audible signal, press the **user pref** pad, number 2 and the **START enter +30 sec** pad.

3. Auto Start

If you wish to program your oven to begin cooking automatically at a designated time of day, follow this procedure:

- Suppose you want to start cooking a stew for 20 minutes on 50% and set keep warm 15 minutes at 4:30. Before setting, check to make sure the clock is showing the correct time of day.

| Step | Press |
|--|---|
| 1. Press the user pref pad. |  |
| 2. Press number 3. |  |
| 3. Enter the start time. Ex : 4:30 |    |
| 4. Press the START enter +30 sec pad. |  |

| Step | Press |
|--|--|
| 5. Enter cooking time. Ex : 20 minutes |   |
| 6. Press the power level pad six times for 50% power. |   x 6 |
| 7. Press the keep warm pad. |  |
| 8. Enter desired time. Ex : 15 minutes |     |
| 9. Press the START enter +30 sec pad. |  |

NOTES

1. Auto Start can be used for manual cooking and keep warm set in conjunction with sequence cooking if clock is set.
2. If the oven door is opened after programming Auto Start, it is necessary to press the **START enter +30 sec** pad for Auto Start time to appear in the display so that the oven will automatically begin programmed cooking at the chosen Auto Start time.
3. Be sure to choose foods that can be left in the oven safely until the Auto Start time. Acorn or butternut squash are often a good choice.
4. After programming Auto Start, open the door and close the door to cancel auto start function.
5. If the electrical power supply to your microwave oven should be interrupted, reset the clock (see page 10) and follow the procedure above to set Auto Start.

CONVENIENT FEATURES

4. Language Selection

The oven comes set for English and U.S. Customary Unit-pounds. Your oven can be selected 3 Languages, English, Spanish or French, and 2 units, pounds or kilograms for each language. To change, press the **user pref** pad and number 4. Continue to press the number 4 until your choice is selected from the table below. Then, press the **START enter +30 sec** pad.

| Press the user pref pad and number 4 | Language | Units |
|--------------------------------------|----------|-------|
| once | | |
| twice | English | LB |
| 3 times | English | KG |
| 4 times | Spanish | LB |
| 5 times | Spanish | KG |
| 6 times | French | LB |
| 7 times | French | KG |
| 8 times | English | LB |

5. Set the Clock





See page 10.

Multiple Sequence Cooking

Your oven can be programmed for up to 4 automatic cooking sequences, switching from one power level setting to another automatically.

Sometimes cooking directions tell you to start on one power level and then change to a different power level. Your oven can do this automatically.

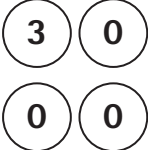
- Suppose you want to cook roast beef for 5 minutes at 100% and then continue to cook for 30 minutes at 50%.

| Step | Press |
|--|---|
| 1. Enter cooking time for 1st stage. |  |
| 2. Press the power level pad once for 100% power for 1st stage. |  |
| 3. Enter second cooking time for 2nd stage. |  |
| 4. Press the power level pad 6 times for 50% power for 2nd stage. |  |

- Press the **START enter +30 sec** pad for 2nd stage.

START enter
+30 sec

NOTES

- If 100% is selected as the final sequence, it is not necessary to press the **power level** pad.
- Keep Warm can be programmed even if 4 cooking sequences have been set.

More or Less Time Adjustment

Should you discover that you like any of SENSOR COOKING or AUTO COOKING slightly more done, press the **power level** pad once after pressing your choice of pads or before pressing the **START enter +30 sec** pad. The display will show *MORE*.

Should you discover that you like any of SENSOR COOKING or AUTO COOKING slightly less done, press the **power level** pad twice after pressing your choice of pads or before pressing the **START enter +30 sec** pad. The display will show *LESS*.

+30 Seconds

+30 seconds allows you to cook for 30 seconds at 100% by simply pressing the **START enter +30 sec** pad. You can also extend cooking time in multiples of 30 seconds by repeatedly pressing the **START enter +30 sec** pad until maximum 99 minutes during manual cooking.

- Suppose you want to heat a cup of soup for 30 seconds.

| Step | Press |
|---|---|
| Press the START enter +30 sec pad. |  |

NOTES

- To use **+30 sec**, press the pad within 3 minutes after cooking, closing the door, pressing the **STOP clear** pad or during cooking.
- +30 seconds cannot be used with SENSOR COOKING and AUTO COOKING.

Help



Each setting has a cooking hint. If you wish to check, press the **user pref** pad whenever *HELP* is lighted in the Interactive Display for these and other manual operation hints.

CONVENIENT FEATURES

Timer

You can easily use Timer function as independent kitchen timer or while using microwave for cooking.

- Suppose you want to time a 3-minute long distance phone call.

| Step | Press |
|---|---|
| 1. Press the timer on-off pad. |  |
| 2. Enter time. |  |
| 3. Press the timer on-off pad. The timer will count down. |  |
| 4. At end of timer, 3 long beeps will sound and words Timer / End will flash in the display. This tells you the timer is completed. To cancel, just touch any key pad. The time of day clock will then appear in display. | |

NOTES

1. **Timer on-off** pad acts as an independent kitchen timer. It can be used before microwave is started for cooking or after microwave has already been started cooking. Timer can not be set while microwave cooking is programming.
2. Timer is always started as example above - touch **timer** pad, enter desired time, press **timer** pad again to start count down.
3. Canceling the Timer function is completed as follows - touch timer pad, then touch **STOP clear** pad. Timer is cancelled. This must be done within 4 seconds after touching **timer** pad. See Timer Operation Table below.
4. When Timer function is completed, 3 long beeps will sound and words Timer / End will flash in the display. This tells you the timer function is completed. To cancel, just touch any key pad. The time of day clock will then appear in display.
5. If using timer when cooking with microwave, when timer is completed, 3 long beeps will sound and words Timer / End will flash in the display. This will continue until timer is cancelled by pressing any key pad. The microwave cooking time will then appear in display.
6. If using timer when cooking with microwave, and cooking is completed and canceled, Timer remaining time will be displayed and continue counting down.

Turntable on/off

Turntable off function is useful when a rack or a large casserole which stop the turntable's rotating are used, for example lasagne or meat. Reposition the foods and/or stir them at least once during

any cooking or reheating time. After cooking or reheating, stir if possible. Using a lower power level will assist in better cooking or reheating uniformity.

Turntable on/off function can be used in Manual Cooking and keep warm in AUTO COOKING. When Turntable on is set, Turntable is turned and when Turntable off is set, Turntable is stopped. When SENSOR COOKING and AUTO COOKING are selected, Turntable on is automatically set for optimum cooking.

Turntable on/off can be set during Manual Cooking and cooking programming by pressing the **turntable on/off** pad.

Quick Start

Quick start is very useful function to start or add to cook from 1 minute to 6 minutes by pressing number from 1 to 6 at 100% power without pressing the **START enter +30 sec** pad. Press number from 1 to 6 within 3minutes after cooking, closing the door, pressing the **STOP clear** pad.

- Suppose you want to cook 2 minutes at 100% power.

| Step | Press |
|-----------------|---|
| Press number 2. |  |

Demonstration Mode

To demonstrate, press the **user pref** pad, number 5, 0 and then press the **START enter +30 sec** pad and hold for three seconds. *DEMO ON DURING DEMO NO OVEN POWER* will appear in the display. Cooking operations and specific special features can now be demonstrated with no power in the oven. For example, press the **START enter +30 sec** pad and the display will show .30 and count down quickly to *END*.

To cancel, press the **user pref** pad, number 5, 0 and the **STOP clear** pad. If easier, unplug the oven from the electrical outlet and replug.

Light

Press the **light hi/lo/off** pad once for high, twice for Low and three times to turn off.

Fan

The fan will automatically start when heat rises from range surface units or burners. This protects the Over the Range Microwave Oven from excessive temperature rise. The fan will stay on until the temperature decreases. It cannot be turned off manually during this time.

For other uses, press the **vent hi/lo/off** pad once for high speed, twice for low speed and three times to turn off.

Timer Operation Table

| | Display | To see timer counting | How to cancel Timer | How to stop or cancel cooking |
|---|------------------------------------|--|--|---|
| Timer use only | Timer counting down | Appears in display at all times | Press STOP clear pad once | - |
| Microwave cooking and timer being used at same time | Microwave cooking is counting down | Press timer on-off pad. Remaining time will appear for 4 seconds, then will change back to microwave cook time. | Press timer on-off pad, then STOP clear pad once. This must be completed within 4 seconds after timer on-off pad. | Stop: Press the STOP clear pad once. Cancel: Press the STOP clear pad twice. |

CLEANING AND CARE

Disconnect the power cord before cleaning or leave the door open to deactivate the oven during cleaning.

EXTERIOR

The outside surface is precoated steel and plastic. Clean the outside with mild soap and water; rinse and dry with a soft cloth. Do not use any type of household or abrasive cleaner.

DOOR

Disconnect the power cord or deactivate the oven with setting Child Lock before cleaning to prevent unexpected manipulation. See Child Lock on page 23. Wipe the window on both sides with a soft cloth to remove any spills or splatters. Metal parts will be easier to maintain if wiped frequently with a soft cloth. Avoid the use of spray and other harsh cleaners as they may stain, streak or dull the door surface.

EASY CARE™ STAINLESS STEEL (SOME MODELS)

Your microwave oven finish may be made with Easy Care™ Stainless Steel (some models). Clean the stainless with warm soapy water using a clean sponge or cloth. Rinse with clean water and dry with a soft clean cloth. **DO NOT** use ANY store bought cleaners like Stainless Steel cleaners or any other types of cleaners containing any abrasive, chlorides, chlorines or ammonia. It is recommended to use mild dish soap and water or a 50/50 solution of water and vinegar.

INTERIOR

Cleaning is easy because little heat is generated to the interior surfaces; therefore, there is no baking and setting of spills or spattering. To clean the interior surfaces, wipe with a soft cloth and warm water. **DO NOT USE ABRASIVE OR HARSH CLEANERS OR SCOURING PADS.** For heavier soil, use baking soda or a mild soap; rinse thoroughly with hot water. The rack can be cleaned with hot soapy water, rinsed and dried.

WAVEGUIDE COVER

The waveguide cover is located on the ceiling in the microwave oven cavity. It is made from mica so requires special care. Keep the waveguide cover clean to assure good microwave oven performance. Carefully wipe with a damp cloth any food splatters from the surface of the cover immediately after they occur. Built-up splashes may overheat and cause smoke or possibly catch fire. **DO NOT REMOVE THE WAVEGUIDE COVER.**

ODOR REMOVAL

Occasionally, a cooking odor may remain in the microwave oven. To remove, combine 1 cup water, grated peel and juice of 1 lemon and several whole cloves in a 2-cup glass measuring cup. Boil for several minutes using 100% power. Allow to set in microwave oven until cool. Wipe interior with a soft cloth.

TURNTABLE/TURNTABLE SUPPORT

The turntable and turntable support can be removed for easy cleaning. Wash them in mild, sudsy water; for stubborn stains use a mild cleanser and non-abrasive scouring sponge. They are also dishwasher-proof. Use upper rack of dishwasher. The turntable motor shaft is not sealed, so excess water or spills should be wiped up immediately.

GREASE FILTERS

Filters should be cleaned at least once a month. Never operate the fan or microwave oven without the filters in place.

1. Pull down slightly on the tab toward the front of the microwave oven and remove the filter. Repeat for the other filter.
2. Soak the filters in a sink or dish pan filled with hot water and detergent. **DO NOT** use ammonia or other alkali; they will react with the filter material and darken it.
3. Agitate and scrub with a brush to remove embedded dirt.
4. Rinse thoroughly and shake dry.
5. Replace by fitting the filter back into the opening.

BOTTOM VIEW

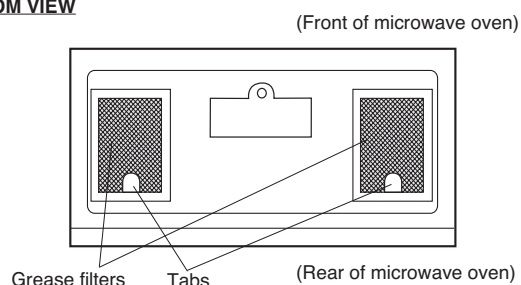

CLEANING AND CARE

Disconnect the power cord before cleaning or leave the door open to deactivate the oven during cleaning.

CHARCOAL FILTERS

Charcoal Filters, which are attached with Hood Louver, are used for nonvented, recirculated installation. The filter should be changed every 6 to 12 months depending on use.

1. Disconnect power to the microwave oven at the circuit breaker panel or by unplugging.
2. Remove three Hood Louver Screws as in Figure 1.
3. Push in the upper tabs and pull the louver away from the unit.
4. Remove the charcoal filters from hood louver and replace new charcoal filters by piercing tabs into the holes in charcoal filters.
5. Carefully push the louver back into place and replace the screws removed at step 2.

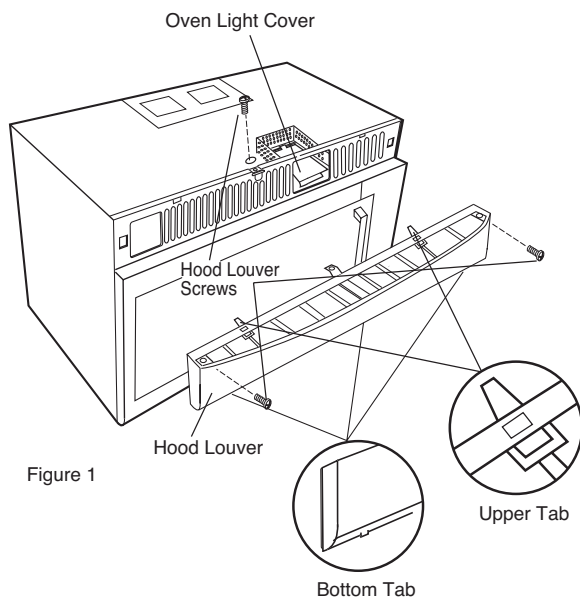

Figure 1

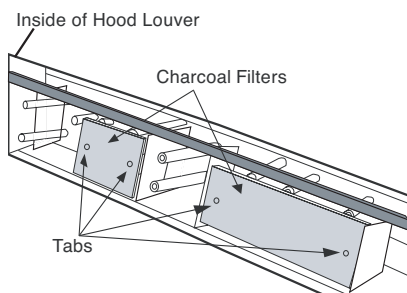

Figure 2

MICROWAVE OVEN LIGHT

1. To replace light bulb, first disconnect power to the microwave oven at the circuit breaker panel or by unplugging.
2. Remove the louver per instructions under Charcoal Filter 2-3. Open oven light cover by carefully pulling up on the front edge. See figure 1.
3. Remove the light bulb and replace with a new 20 watt light bulb. **DO NOT USE BULB LARGER THAN 20 WATTS.**
4. Close the Oven Light Cover by carefully pushing into place. Push the louver back into place (engaging both the bottom and top tabs) and change to hood Louver Screws.

WORK/NIGHT LIGHT

1. To replace light bulbs, first disconnect power to the microwave oven at the circuit breaker panel or by unplugging.
2. To open Light Cover, remove the screw on the light cover. (See Figure 3.)
3. Replace the light bulbs with new 20 watt light bulbs. **DO NOT USE BULBS LARGER THAN 20 WATTS.**
4. Close the Light Cover and secure with screw removed at step 2.

BOTTOM VIEW

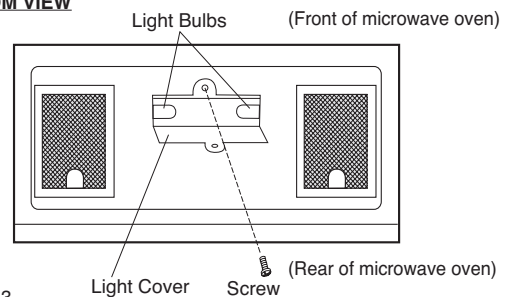

Figure 3



CAUTION

Light Cover may become very hot. Do not press glass when light is on.

SERVICE CALL CHECK

Please check the following before calling for service:

Place one cup of water in a glass measuring cup in the oven and close the door securely.

Operate the oven for one minute at HIGH 100%.

- | | | | |
|---|---|-----------|----------|
| A | Does the oven light come on? | YES _____ | NO _____ |
| B | Does the cooling fan work? (Put your hand over the left side of louver.) | YES _____ | NO _____ |
| C | Is the water in the oven warm? | YES _____ | NO _____ |

If A is "NO", then you need to check light bulb. See page 27 for removal.

If "NO" is the answer to any of the above questions, please check electrical outlet, fuse and/ or circuit breaker. If they are functioning properly, CONTACT YOUR NEAREST ELECTROLUX AUTHORIZED SERVICER.

A microwave oven should never be serviced by a "do-it-yourself" repair person.



NOTES

1. If time appearing in the display is counting down very rapidly, check Demonstration Mode on page 25 and cancel.
2. If the oven is set for 40 minutes and over at 80, 90 or 100 percent power level, after the first 40 minutes the power level will automatically adjust itself to 70 percent power to avoid overcooking.

SPECIFICATIONS

| | |
|--|--|
| AC Line Voltage: | Single phase 120V, 60Hz, AC only |
| AC Power Required: | 1650 W 14.3 amps. (FGMV205KB,FGMV205KF,FGMV205KW FPMV189KF) |
| Output Power*: | 1000 watts |
| Frequency: | 2450 MHz |
| Outside Dimensions (including handle): | 29 15/16"(W) x 17 1/16"(H) x 18 15/32"(D) |
| Cavity Dimensions: | 22 1/2"(W) x 10 1/16"(H) x 14 31/32"(D) |
| Microwave oven Capacity**: | 2.0 Cu.Ft. |
| Weight: | Approx. (net) 61 lb, (gross) 73 lb |
| Work/Night Light: | 2 bulbs 20w each (incandescent light bulbs) |

* The International Electrotechnical Commission's standardized method for measuring output wattage. This test method is widely recognized.

** Internal capacity is calculated by measuring maximum width, depth and height. Actual capacity for holding food is less.

In compliance with standards set by:

- FCC - Federal Communications Commission Authorized.
- DHHS - Complies with Department of Health and Human Services (DHHS) rule, CFR, Title 21, Chapter I, Subchapter J.
-  - This symbol on the nameplate means the product is listed by Underwriters Laboratories, Inc.

MAJOR APPLIANCE WARRANTY INFORMATION

Your appliance is covered by a one year limited warranty. For one year from your original date of purchase, Electrolux will pay all costs for repairing or replacing any parts of this appliance that prove to be defective in materials or workmanship when such appliance is installed, used and maintained in accordance with the provided instructions.

Exclusions **This warranty does not cover the following:**

1. Products with original serial numbers that have been removed, altered or cannot be readily determined.
2. Product that has been transferred from its original owner to another party or removed outside the USA or Canada.
3. Rust on the interior or exterior of the unit.
4. Products purchased "as-is" are not covered by this warranty.
5. Food loss due to any refrigerator or freezer failures.
6. Products used in a commercial setting.
7. Service calls which do not involve malfunction or defects in materials or workmanship, or for appliances not in ordinary household use or used other than in accordance with the provided instructions.
8. Service calls to correct the installation of your appliance or to instruct you how to use your appliance.
9. Expenses for making the appliance accessible for servicing, such as removal of trim, cupboards, shelves, etc., which are not a part of the appliance when it is shipped from the factory.
10. Service calls to repair or replace appliance light bulbs, air filters, water filters, other consumables, or knobs, handles, or other cosmetic parts.
11. Surcharges including, but not limited to, any after hour, weekend, or holiday service calls, tolls, ferry trip charges, or mileage expense for service calls to remote areas, including the state of Alaska.
12. Damages to the finish of appliance or home incurred during installation, including but not limited to floors, cabinets, walls, etc.
13. Damages caused by: services performed by unauthorized service companies; use of parts other than genuine Electrolux parts or parts obtained from persons other than authorized service companies; or external causes such as abuse, misuse, inadequate power supply, accidents, fires, or acts of God.

DISCLAIMER OF IMPLIED WARRANTIES; LIMITATION OF REMEDIES

CUSTOMER'S SOLE AND EXCLUSIVE REMEDY UNDER THIS LIMITED WARRANTY SHALL BE PRODUCT REPAIR OR REPLACEMENT AS PROVIDED HEREIN. CLAIMS BASED ON IMPLIED WARRANTIES, INCLUDING WARRANTIES OF MERCHANTABILITY OR FITNESS FOR A PARTICULAR PURPOSE, ARE LIMITED TO ONE YEAR OR THE SHORTEST PERIOD ALLOWED BY LAW, BUT NOT LESS THAN ONE YEAR. ELECTROLUX SHALL NOT BE LIABLE FOR CONSEQUENTIAL OR INCIDENTAL DAMAGES SUCH AS PROPERTY DAMAGE AND INCIDENTAL EXPENSES RESULTING FROM ANY BREACH OF THIS WRITTEN LIMITED WARRANTY OR ANY IMPLIED WARRANTY. SOME STATES AND PROVINCES DO NOT ALLOW THE EXCLUSION OR LIMITATION OF INCIDENTAL OR CONSEQUENTIAL DAMAGES, OR LIMITATIONS ON THE DURATION OF IMPLIED WARRANTIES, SO THESE LIMITATIONS OR EXCLUSIONS MAY NOT APPLY TO YOU. THIS WRITTEN WARRANTY GIVES YOU SPECIFIC LEGAL RIGHTS. YOU MAY ALSO HAVE OTHER RIGHTS THAT VARY FROM STATE TO STATE.

If You Need Service Keep your receipt, delivery slip, or some other appropriate payment record to establish the warranty period should service be required. If service is performed, it is in your best interest to obtain and keep all receipts. Service under this warranty must be obtained by contacting Electrolux at the addresses or phone numbers below.

This warranty only applies in the USA and Canada. In the USA, your appliance is warranted by Electrolux Major Appliances North America, a division of Electrolux Home Products, Inc. In Canada, your appliance is warranted by Electrolux Canada Corp. Electrolux authorizes no person to change or add to any obligations under this warranty. Obligations for service and parts under this warranty must be performed by Electrolux or an authorized service company. Product features or specifications as described or illustrated are subject to change without notice.

USA
1.800.944.9044
Electrolux Major Appliances
North America
10200 David Taylor Drive
Charlotte, NC 28262



Canada
1.800.265.8352
Electrolux Canada Corp.
5855 Terry Fox Way
Mississauga, Ontario, Canada
L5V 3E4