

Microwave Oven

use & care

Introduction	2
Precautions Microwave Energy	3
Important Safety Instructions	4-7
Countertop Installation	8
Names Of Oven Parts And Accessories	9
Operation	10-16

Maintenance	17-18
Cleaning And Care	19
Service Call Check	20
Warranty	21

2

INTRODUCTION

Welcome to our *family*

Thank you for bringing Frigidaire into your home! We see your purchase as the beginning of a long relationship together.

This manual is your resource for the use and care of your product. Please read it before using your appliance. Keep it handy for quick reference. If something doesn't seem right, the troubleshooting section will help you with common issues.

FAQs, helpful tips and videos, cleaning products, and kitchen and home accessories are available at www.frigidaire.com.

We are here for you! Visit our website, chat with an agent, or call us if you need help. We may be able to help you avoid a service visit. If you do need service, we can get that started for you.

Let's make it official! Be sure to register your product.

Keep your product info here so it's easy to find.

Model Number: _____

Serial Number: _____

Purchase Date: _____

Let's make it official! Be sure to register your product.

Visit us at Frigidaire.com/register

Or use your mobile device to scan the QR code.

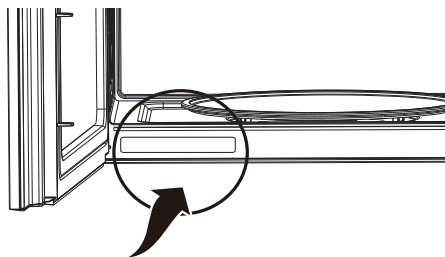

Serial Number Location

PRECAUTIONS TO AVOID POSSIBLE EXPOSURE TO EXCESSIVE MICROWAVE ENERGY

Do not attempt to operate this oven with the door open since open door operation can result in harmful exposure to microwave energy. It is important not to defeat or tamper with the safety interlocks.

Do not place any object between the oven front face and the door or allow soil or cleaner residue to accumulate on sealing surfaces.

WARNING

To reduce the risk of burns, electric shock, fire, injury to persons or exposure to excessive microwave energy:

Do not operate the oven if it is damaged. It is particularly important that the oven door close properly and that there is no damage to the:

- (1) DOOR (bent)
- (2) HINGES AND LATCHES (broken or loosened)
- (3) DOOR SEALS AND SEALING SURFACES.

The oven should not be adjusted or repaired by anyone except properly qualified service personnel.

This device complies with part 18 of the FCC Rules. (Only for USA)

RADIO INTERFERENCE

- Operation of the microwave oven may cause interference to your radio, TV or similar equipment.
- When there is interference, it may be reduced or eliminated by taking the following measures:
 - Clean door and sealing surface of the oven.
 - Reorient the receiving antenna of radio or television.
 - Relocate the microwave oven with respect to the receiver.
 - Move the microwave oven away from the receiver.
 - Plug the microwave oven into a different outlet so that microwave oven and receiver are on different branch circuits.

UTENSILS

CAUTION

- Personal Injury Hazard

- Tightly-closed utensils could explode. Closed containers should be opened and plastic pouches should be pierced before cooking.
- See the instructions on "Materials you can use in microwave oven or to be avoided in microwave oven."

There may be certain non-metallic utensils that are not safe to use for microwaving. If in doubt, you can test the utensil in question following the procedure below.

Utensil Test:

- Fill a microwave-safe container with 1 cup of cold water (250ml) along with the utensil in question.
- Cook on maximum power for 1 minute.
- Carefully feel the utensil. If the empty utensil is warm, do not use it for microwave cooking.
- Do not exceed 1 minute cooking time.

SAVE THESE INSTRUCTIONS

4 **IMPORTANT SAFETY INSTRUCTIONS**

Read all instructions before using this appliance.

This manual contains important safety symbols and instructions. Please pay attention to these symbols and follow all instructions given.

Do not attempt to install or operate your appliance until you have read the safety precautions in this manual. Safety items throughout this manual are labeled with a WARNING or CAUTION statement based on the risk type.

Warnings and important instructions appearing in this guide are not meant to cover all possible conditions and situations that may occur. Common sense, caution, and care must be exercised with installing, maintaining, or operating your appliance.

DEFINITIONS

 This is the safety alert symbol. It is used to alert of potential personal injury hazards. Obey all safety messages that follow this symbol to avoid possible injury or death.

WARNING

Indicates a potentially hazardous situation which, if not avoided, may result in death or serious injury.

CAUTION

Indicates a potentially hazardous situation which, if not avoided, may result in minor or moderate injury.

NOTE

Indicates a short, informal reference - something written down to assist the memory or for future reference.

IMPORTANT

Indicates installation, operation or maintenance information which is important but not hazard-related.

NOTE

ELECTRICAL REQUIREMENTS

Product rating is 120 volts AC, 60 Hertz, 1.5 kilowatts and 13.5 amps. This product must be connected to a separate and dedicated supply circuit of the proper voltage and frequency. Wire size must conform to the requirements of the National Electrical Code or the prevailing local code for this kilowatt rating. The power supply cord and plug should be brought to a separate and dedicated 15- to 20-ampere branch circuit single grounded outlet. The outlet box should be located in the cabinet above the microwave oven. The outlet box and supply circuit should be installed by a qualified electrician and conform to the National Electrical Code or the prevailing local code.

IMPORTANT

1. If you have any questions about the grounding or electrical instructions, consult a qualified electrician or service person.
2. Neither Electrolux nor the dealer can accept any liability for damage to the microwave oven or personal injury resulting from failure to observe the correct electrical connection procedures.

SAVE THESE INSTRUCTIONS

When using electrical appliances basic safety precautions should be followed, including the following:

WARNING

To reduce the risk of burns, electric shock, fire, injury to persons or exposure to excessive microwave energy:

- Read all instructions before using the appliance.
- Read and follow the specific: "PRECAUTIONS TO AVOID POSSIBLE EXPOSURE TO EXCESSIVE MICROWAVE ENERGY" found on page 3.
- This appliance must be grounded. Connect only to properly grounded outlet. See "GROUNDING INSTRUCTIONS" found on page 6.
- Install or locate this appliance only in accordance with the provided installation instructions.
- Some products such as whole eggs and sealed containers - for example, closed glass jars - are able to explode and should not be heated in this oven.
- Use this appliance only for its intended use as described in the manual. Do not use corrosive chemicals or vapors in this appliance. This type of oven is specifically designed to heat, cook or dry food. It is not designed for industrial or laboratory use.
- **HOT CONTENTS CAN CAUSE SEVERE BURNS. DO NOT ALLOW CHILDREN TO USE THE MICROWAVE.** Use caution when removing hot items.
- Do not operate this appliance if it has a damaged cord or plug, if it is not working properly, or if it has been damaged or dropped.
- This appliance should be serviced only by qualified service personnel. Contact nearest authorized service facility for examination, repair, or adjustment.
- Do not cover or block any openings on the appliance.
- Do not store this appliance outdoors. Do not use this product near water - for example, near a kitchen sink, in a wet basement, near a swimming pool, or similar location.
- Do not immerse cord or plug in water.
- Keep cord away from heated surface.
- Do not let cord hang over edge of table or counter. When cleaning surfaces of door and oven that comes together on closing the door, use only mild, nonabrasive soaps, or detergent applied with a sponge or soft cloth.
- To reduce the risk of fire in the oven cavity:
 - Do not overcook food. Carefully attend appliance when paper, plastic, or other combustible materials are placed inside the oven to facilitate cooking.
 - Remove wire twist-ties from paper or plastic bag before when placing bag in oven.
 - If material inside of the oven ignite, keep oven door closed, turn oven off, and disconnect the power cord, or shut off power at the fuse or circuit breaker panel.
 - Do not use the cavity for storage purposes. Do not leave paper products, cooking utensils, or food in the cavity when not in use.
- Liquids, such as water, coffee, or tea are able to be overheated beyond the boiling point without appearing to be boiling. Visible bubbling or boiling when the container is removed from the microwave oven is not always present. **THIS COULD RESULT IN VERY HOT LIQUID SUDDENLY BOILING OVER WHEN THE CONTAINER IS DISTURBED OR A UTENSIL IS INSERTED INTO THE LIQUID.** To reduce the risk of injury to persons:
 - Do not overheat the liquid.
 - Stir the liquid both before and halfway through heating it.
 - Do not use straight-sided containers with narrow necks.
 - After heating, allow the container to stand in the microwave oven for a short time before removing the container.
 - Use extreme care when inserting a spoon or other utensil into the container.
 - Oversized food or oversized metal utensils should not be inserted in a microwave oven as they may create a fire or risk of electric shock. Do not clean with metal scouring pads. Pieces can burn off the pad and touch electrical parts involving a risk of electric shock.
 - Do not store any materials, other than manufacturer's recommended accessories, in this oven when not in use.
 - Do not cover racks or any other part of the oven with metal foil. This will cause over- heating of the oven.
 - Clean Ventilation Hoods Frequently -Grease should not be allowed to accumulate on hood or filter.
 - When flaming foods under the hood, turn the fan on.
 - Use care when cleaning the vent-hood filter. Corrosive cleaning agents, such as lye-based oven cleaners, may damage the filter.
 - Suitable for use above both gas and electric cooking equipment.

SAVE THESE INSTRUCTIONS

6 IMPORTANT SAFETY INSTRUCTIONS

GROUNDING INSTRUCTIONS

This appliance must be grounded. In the event of an electrical short circuit, grounding reduces the risk of electric shock by providing an escape wire for the electric current. This appliance is equipped with a cord having a grounding wire with a grounding plug. The plug must be plugged into an outlet that is properly installed and grounded.

WARNING

Improper use of the grounding can result in a risk of electric shock.

Consult a qualified electrician or serviceman if the grounding instructions are not completely understood, or if doubt exists as to whether the appliance is properly grounded. If it is necessary to use an extension cord, use only a 3-wire extension cord that has a 3-blade grounded plug, and 3-slot receptacle that will accept the plug on the appliance. The marked rating of the extension cord shall be equal to or greater than the electrical rating of the appliance.

IMPORTANT

1. If you have any questions about the grounding or electrical instructions, consult a qualified electrician or service person.
2. Neither Electrolux nor the dealer can accept any liability for damage to the microwave oven or personal injury resulting from failure to observe the correct electrical connection procedures.

DANGER

Electric Shock Hazard

Touching some of the internal components can cause serious personal injury or death. Do not disassemble this appliance.

WARNING

Electric Shock Hazard

Improper use of the grounding can result in electric shock. Do not plug into an outlet until appliance is properly installed and grounded.

- A short power supply cord is provided to reduce the risks resulting from becoming entangled in or tripping over a longer cord.
- Longer cord sets or extension cords are available and may be used if care is exercised in their use.
- If a long cord or extension cord is used:
 - The marked electrical rating of the cord set or extension cord should be at least as great as the electrical rating of the appliance.
 - The extension cord must be a grounding-type 3-wire cord.
 - The longer cord should be arranged so that it will not drape over the counter top or tabletop where it can be pulled on by children or tripped over unintentionally.

SAVE THESE INSTRUCTIONS

Materials you can use in microwave oven

Browning dish	Follow manufacturer instructions. The bottom of browning dish must be at least 3/16 inch (5mm) above the turntable. Incorrect usage may cause the turntable to break.
Dinnerware	Microwave-safe only. Follow manufacturer's instructions. Do not use cracked or chipped dishes.
Glass jars	Always remove lid. Use only to heat food until just warm. Most glass jars are not heat resistant and may break.
Glassware	Heat-resistant oven glassware only. Make sure there is no metallic trim. Do not use cracked or chipped dishes.
Oven cooking bags	Follow manufacturer instructions. Do not close with metal tie. Make slits to allow steam to escape.
Paper plates and cups	Use for short term cooking/warming only. Do not leave oven unattended while cooking.
Paper towels	Use to cover food for reheating and absorbing fat. Use with supervision for a short-term cooking only.
Parchment paper	Use as a cover to prevent splattering or a wrap for steaming.
Plastic	Microwave-safe only. Follow the manufacturer instructions. Should be labeled "Microwave Safe". Some plastic containers soften, as the food inside gets hot. "Boiling bags" and tightly closed plastic bags should be slit, pierced or vented as directed by package.
Plastic wrap	Microwave-safe only. Use to cover food during cooking to retain moisture. Do not allow plastic wrap to touch food.
Thermometers	Microwave-safe only (meat and candy thermometers).
Wax paper	Use as a cover to prevent splattering and retain moisture.

Materials to be avoided in microwave oven

Aluminum tray	May cause arcing. Transfer food into microwave-safe dish.
Food carton with metal handle	May cause arcing. Transfer food into microwave-safe dish.
Metal or metal-trimmed utensils	Metal shields the food from microwave energy. Metal trim may cause arcing.
Metal twist ties	May cause arcing and could cause a fire in the oven.
Paper bags	May cause a fire in the oven.
Plastic foam	Plastic foam may melt or contaminate the liquid inside when exposed to high temperature.
Wood	Wood will dry out when used in the microwave oven and may split or crack.

8

COUNTER TOP INSTALLATION

1. Select a level surface that provides enough open space for the intake and/or outlet vents.

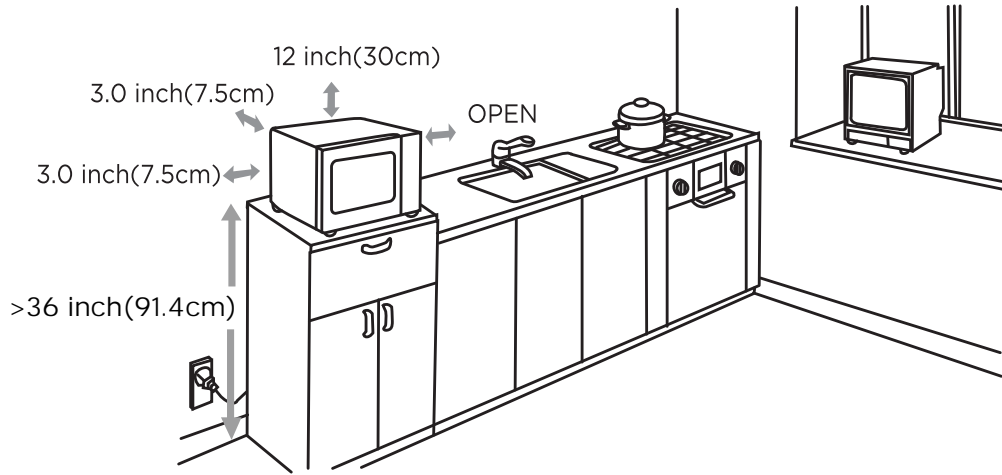

A minimum clearance of 3.0 inches (7.5cm) is required between the oven and any adjacent walls. One side must be open.

- (1) Leave a minimum clearance of 12 inches (30cm) above the oven.
- (2) Do not remove the legs from the bottom of the oven.
- (3) Blocking the intake and/or outlet openings can damage the oven.
- (4) Place the oven as far away from radios and TV as possible. Operation of microwave oven may cause interference to your radio or TV reception.
- (5) Plug your oven into a standard household outlet.
Be sure the voltage and the frequency is the same as the voltage and the frequency on the rating label.
- (6) The minimum installation height is 36 inches (91.4cm).

Sold Separately

Built-in Trim Kit allows for the installation of microwaves listed below to be built into a cabinet or wall by itself or over an electric self-clean or non self-clean single cavity wall oven. See both wall oven and trim kit installation instructions

Model Number	Color	Description
PMBS3080BF	Easy Care SS	Microwave
PMTK3080AF	Easy Care SS	30" Trim Kit

NAMES OF OVEN PARTS AND ACCESSORIES

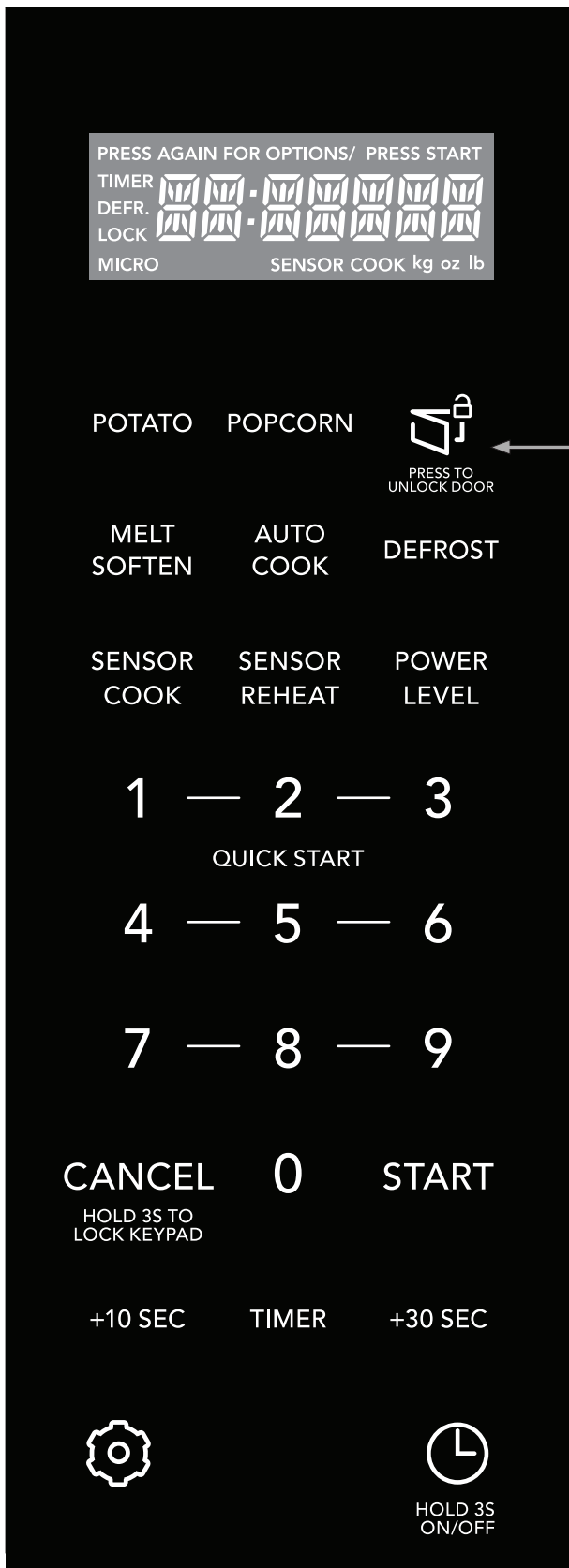

See page 10 for door operation

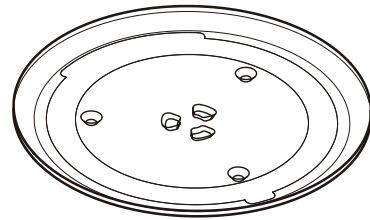

Glass turntable

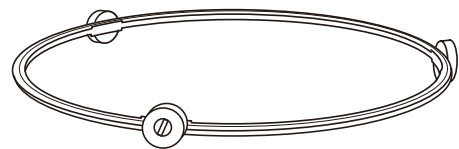

Turntable Ring Assembly

10 OPERATION

SAFETY LOCK

The two step function is provided to allow the consumer an option to limit access to contents from children during and after cooking.

The microwave will be in standby mode requiring only a single step to open the door when no cooking is in process.

TO OPEN THE DOOR:

During the cooking or within 30 minutes after the end of cooking the microwave will require two steps to open the door.

1. Touch



2. Push door button

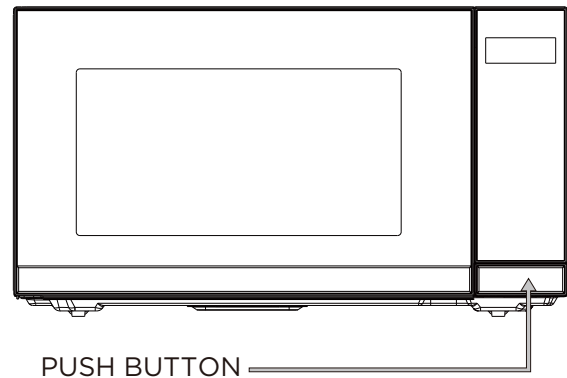

NOTE

- 1 After 30 minutes of the end of cooking, the oven door will be unlocked.
2. After touching “” once to unlock the door, you must open the oven door within 10 seconds. Otherwise, the oven door will be locked again.
3. When you open the oven door in the cooking process, the oven door will be unlocked until the oven starts cooking again.
4. When you open the oven door within 30 minutes after the end of cooking, the oven door will be unlocked and the oven will return to standby mode.

TO DEACTIVATE/REACTIVATE THE SAFETY LOCK:

If there are no children in the house, you can choose to permanently deactivate the safety lock function.

1. Touch

0

2. Touch



3. Hold 3 seconds

CANCEL
HOLD 3S TO
LOCK KEYPAD

NOTE



All three must be touch within 30 seconds, then the screen will display “UNLOC”.

To reactivate the safety lock, repeat steps.

1. Before operating your new oven make sure you read and understand this Use and Care Guide completely.
2. Before the Built-in Convection Microwave Oven can be used, follow these procedures:
 - Plug in the oven. Close the door. The oven display will flash 12:00.
 - If no operation after 1 minute, the oven will show 12:01.
3. Set clock. See below.



SETTING THE CLOCK

Example: setting clock display for 9:00:

1. Touch  pad once . 
2. Enter time using number pads. **9 0 0**
3. Touch START pad. **START**

SETTING THE CLOCK ON/OFF

Clock display ON default.

1. Touch  and hold pad . 
2. Time will display, after 3s, OFF will display. **OFF**

NOTE

When the clock display off:

Press the button  to enter the clock query state and return to the standby mode after 1 second. The clock is not displayed.

Hold down the  key for 1-3 seconds to display the current clock. After 1 second, display the current clock and enter the clock setting mode.

SETTING THE TIMER

Example: setting timer for 5 minutes:

1. Touch TIMER pad once. **TIMER**
2. Enter desired time using number pads. **5 0 0**
3. Touch TIMER pad. **TIMER**

Timer count down does not stop even if the door is opened. To stop/cancel the timer, press the TIMER key once . When the timer has reached the end of set time, you will hear beep alerts indicating the timer has run out.

CONTROL LOCK

You may lock the control panel to prevent the microwave from being accidentally started or used by children. The control lock feature is very useful when cleaning the control panel. The lock will prevent accidental programming when wiping the control panel clean.

Example: to set the control lock ON:

Touch and hold the CANCEL pad for more than 3 seconds. The Lock icon will appear in the display window along with 1 beep. **CANCEL HOLD 3S TO LOCK**

Example: to change the control lock from ON to OFF:

Touch and hold the CANCEL pad for more than 3 seconds. The Lock icon will disappear in the display window. **CANCEL HOLD 3S TO LOCK**

USING THE +10 SEC /+ 30 SEC KEY

This feature will let you quickly start or add 10 or 30 seconds

Touch the +10 SEC/+30 SEC pad to: **+10 SEC/ +30 SEC**

1. Start programmed cooking.
2. Start cooking for 10 seconds/30 seconds at 100% power level.
3. Extend cooking time in multiples of 10 seconds/30 seconds each time this pad is touched during microwave cooking.

Example: to add 1 minute of cook time during 100% microwave cooking :

Press +30SEC pad twice. **+30 SEC**

12 OPERATION

NOTE

"Food" will be displayed if a quick start cooking cycle or +10 Sec /+30 Sec key is pressed more than 5 minutes after the door of microwave oven is closed. You must open then door again to clear "Food" from the display.

USING QUICK START

1 — 2 — 3

QUICK START

4 — 5 — 6

7 — 8 — 9

Microwave heating or cooking may be quickly set at 100% power level for 1-9 minutes. Use the number keys 1-9 to choose the desired minutes of cook time (this option will only work using the 1-9 numeric pads).

Example: to quickly heat for 2 minutes at 100% power:

Press number pad for desired minute(s). **2**
The microwave will start at once.

HEATING WITH HIGH POWER LEVEL

Example: to heat for 5 minutes and 30 seconds at 100%power:

1. Use the number pads to enter desired heating time. **5 3 0**

NOTE

For time sets that start with numbers 1 - 9, the remaining numbers must be entered within 2 second from the first key press, otherwise the Quick Start time will be used.

2. Press START pad. **START**

When finished, you will hear a series of beeps.

HEATING WITH LOWER POWER LEVELS

Using the highest power level to heat foods does not always give the best results when some types of food need slower cooking, such as roasts, baked goods or custards. Your oven has nine other power levels you may choose.

Example: to heat for 4 minutes and 30 seconds at 70%power:

1. Press Power Level pad. Power Level
2. Press Power Level four times or press the number keys 7 to change to 70% power level. PL-70 appears in the display.
3. Press START pad. **START**
4. Use the number pads to enter heating time. **4 3 0**
5. Press START pad. **START**

When finished, you will hear a series of beeps.

NOTE

1. For time settings that start with numbers 1 - 9, the remaining numbers must be entered within 2 second from the first key press, otherwise the Quick Start time will be used.
2. For power level settings, you can easily select a level using the number keys 1-9.

HEATING WITH MULTIPLE COOKING STAGES

For best results, some microwave recipes call for different power levels or different lengths of time for cooking. Your microwave may be set to change from one stage to another automatically (2 stages maximum).

Example: to cook food at 80% power for 3 minutes and then 50% power for 6 minutes 30 seconds:

1. Press Power Level pad. Power Level
2. Press Power Level three times or press the number keys 8 to change to 80% power level. PL-80 appears in the display.

OPERATION 13

3. Press START pad. START
4. Use the number pads to enter heating time for the 1st stage. 3 0 0
5. Press Power Level (within 1 second) for the 2nd stage. Power Level
6. Press Power Level six times or press the number keys 5 to change to 50% power level. PL-50 appears in the display.
7. Press START pad. START

When finished, you will hear a series of beeps.

NOTE

The “Convenience operation” can’t be set as one of multiple cooking.

AUTO COOK

Do not leave microwave unattended during any of auto cook selections.

Key Press	Food	Amount	Key
Auto Cook x1	Bacon	1 - 3 slices	1 - 3
Auto Cook x2	Frozen Entrée	10 oz 20 oz	-
Auto Cook x3	Rice	1 cup 2 cups	-

Example: to cook Rice.

1. Press AUTO COOK pad 3 times. AUTO COOK
2. Press START pad. START

The microwave will beep when finished.

USING AUTO DEFROST

Three defrost sequences are preset in the oven. The auto defrost feature provides you with the best defrosting method for frozen foods. The cooking guide will show you which defrost sequence is recommended for the food you are defrosting.

For added convenience, the Auto Defrost includes a built-in beep mechanism that reminds you to check, turn over, separate, or rearrange the food in order to get the best defrost results. Three different defrosting levels are provided:

1. MEAT
2. POULTRY
3. FISH

Available weight is 0.1 to 6.0 lbs.

Suppose you want to defrost 2.0 lbs of meat.

1. Press DEFROST pad. DEFROST
2. Press START pad. START
3. Enter cook weight 2 0
4. Press START pad. START
(Refer the table on next page)

KEY PRESS	Category	WEIGHTS YOU CAN SET (tenths of a pound)
Defrost	Meat	0.1 to 6.0
Defrost	Poultry	0.1 to 6.0
Defrost	Fish	0.1 to 6.0

POPCORN

CAUTION

DO NOT leave microwave oven unattended while popping popcorn|.

The popcorn feature lets you pop 3 different commercially packaged microwave popcorn sized bags. Use the table below to determine the setting to use:

14 OPERATION

KEY	Food
Popcorn x1	3.3 oz. (default)
Popcorn x2	3.0 oz.
Popcorn x3	1.75 oz.

Example: to pop a 1.75 oz. bag of popcorn automatically:

1. Press POPCORN pad 3 times (refer to table above). **POPCORN**
2. Press START pad. **START**

When finished, you will hear a series of beeps.

SETTING MELT/SOFTEN

The oven uses low power to melt and soften items. See the following table.

KEY	Food	Amount	KEY
Melt / Soften x1	Melt Butter	1 stick	1
		2 sticks	2
Melt / Soften x2	Melt Chocolate	2 oz.	2
		4 oz.	4
		8 oz.	8
Melt / Soften x3	Soften Ice Cream	1 Pint	1
		1.5 Quart	2
Melt / Soften x4	Soften Cream Cheese	3 oz.	3
		8 oz.	8

Suppose you want to melt 8 oz. of Chocolate.

1. Press MELT SOFTEN pad 2 times (refer to table above). **MELT SOFTEN**
2. Press START pad. **START**
3. Enter cook weight. **8**
4. Press START pad. **START**

SENSOR COOK OPERATING TIPS

The Sensor Cook categories are designed to detect the increasing humidity released by the food during the cooking process. The microwave oven sensor will automatically adjust the cooking time to the type and amount of food. The food categories that are controlled with the humidity sensor are:

KEY	Food
Sensor Cook x1	Frozen Breakfast (8-12oz)
Sensor Cook x2	Ground Meat
Sensor Cook x3	Fish Seafood
Sensor Cook x4	Chicken Breast
Sensor Cook x5	Fresh veggies
Sensor Cook x6	Frozen veggies

OPERATION 15

For best results, do not use one of the Sensor Cook categories twice in succession on the same food portion. This may result in severely overcooked or burnt food. If the food appears to be undercooked, use one of the Easy Set pads or cook time pads to add more time.

Additional sensor cook suggestions are:

- Never start with less than 4 oz. of food.
- Use proper containers and covers for best sensor cooking results.
- Always use microwave-safe containers.
- Never use tight sealing plastic containers.
- They will prevent steam from escaping and this will mislead the sensor, usually causing the food to overcook.

Be sure the outside of the cooking containers and the cavity of the microwave oven are dry before placing food in the oven. Excessive moisture turning into steam that does not result from the food cooking can mislead the sensor.

Suppose you want to cook Frozen Breakfast.

- | | |
|-------------------------------|----------------|
| 1. Press the SENSOR COOK pad. | SENSOR
COOK |
| 2. Press START pad. | START |

Suppose you want to cook Fish Seafood.

- | | |
|---|----------------|
| 1. Press the SENSOR COOK pad three times. | SENSOR
COOK |
| 2. Press START pad. | START |

SENSOR REHEAT

The reheat feature is designed to detect the increasing humidity released by the food during the cooking process. The microwave oven sensor will automatically adjust the cooking time to the type and amount of food.

KEY	Selection	Amount
Sensor Reheat x1	Beverage	1 - 3 cups
Sensor Reheat x2	Dinner Plate	1 - 2 plates
Sensor Reheat x3	Soup - Sauce	1 - 2 cups
Sensor Reheat x4	Casserole	1 - 4 servings

Notes concerning sensor reheat:

- For casseroles, add 2 - 3 tablespoons of liquid, cover with lid or vented plastic wrap. Stir when instructed from display.
- For canned foods, empty contents of can into a casserole dish or serving bowl. Cover dish with lid or vented plastic wrap. Let stand a few minutes before serving.
- For plates of food, arrange food on plate and add any butter or gravies, etc. Cover with loose-fitting lid or vented plastic wrap. After reheating, let stand a few minutes before serving.

Example: suppose you want to reheat 1 cup beverage.

- | | |
|-----------------------------|------------------|
| 1. Press SENSOR REHEAT pad. | SENSOR
REHEAT |
| 2. Press START pad. | START |
| 3. Enter 1. | 1 |
| 4. Press START pad. | START |

BAKED POTATO

The potato feature cooks 1 - 4 baked potato automatically (starting from room temperature).

- | | |
|--------------------------|--------|
| 1. Press the POTATO pad. | POTATO |
| 2. Press START pad. | START |

16 OPERATION

USER REFERENCE

This section gives instructions for operating each function. Please read this section carefully.

PREFERENCES

The microwave oven has settings that allow you to customize the operation for your convenience. Below is the table showing the various settings. Touch the User Pref key multiple times to scroll to the desired setting function.

KEY	Function
User Pref x 1	Volume
User Pref x 2	Weight
User Pref x 3	Language
User Pref x 4	Demo Mode

SETTING AUDIO LOW/MED/HIGH/OFF

Suppose you want to turn on the Volume Off.

1. Press the User Pref pad once. 
2. Press START pad when display indicates volume level is off. **START**

SETTING WEIGHT LBS/KG

Suppose you want to toggle weight between pounds & kilograms.

1. Press the User Pref pad twice. 
2. Press START pad. **START**

SETTING LANGUAGE MODE

Suppose you want to enter Language Mode.

1. Press the User Pref pad three times. 
2. Press START pad. **START**

SETTING DEMO MODE

Suppose you want to enter Demo Mode.

1. Press the User Pref pad four times. 
2. Press START pad. **START**

Troubleshooting

Check your problem by using the chart below and try the solutions for each problem. If the microwave oven still does not work properly, contact the nearest authorized service center.

TROUBLE	POSSIBLE CAUSE	POSSIBLE REMEDY
Oven will not start	<ul style="list-style-type: none"> • Electrical cord for oven is not plugged in. • Door is open. • Wrong operation is set. 	<ul style="list-style-type: none"> • Plug into the outlet. • Close the door and try again. • Check instructions.
Arcing or sparking	<ul style="list-style-type: none"> • Materials to be avoided in microwave oven were used. • The oven is operated when empty. • Spilled food remains in the cavity. 	<ul style="list-style-type: none"> • Use microwave-safe cookware only. • Do not operate with oven empty. • Clean cavity with wet towel.
Unevenly cooked foods	<ul style="list-style-type: none"> • Materials to be avoided in microwave oven were used. • Food is not defrosted completely. • Cooking time, power level is not suitable. • Food is not turned or stirred. 	<ul style="list-style-type: none"> • Use microwave-safe cookware only. • Completely defrost food. • Use correct cooking time, power level. • Turn or stir food.
Overcooked foods	<ul style="list-style-type: none"> • Cooking time, power level is not suitable. 	<ul style="list-style-type: none"> • Use correct cooking time, power level.
Undercooked foods	<ul style="list-style-type: none"> • Materials to be avoided in microwave oven were used. • Food is not defrosted completely. • Oven ventilation ports are restricted. • Cooking time, power level is not suitable. 	<ul style="list-style-type: none"> • Use microwave-safe cookware only. • Completely defrost food. • Check to see that oven ventilation ports are not restricted. • Use correct cooking time, power level.
Improper defrosting	<ul style="list-style-type: none"> • Materials to be avoided in microwave oven were used. • Cooking time, power level is not suitable. • Food is not turned or stirred. 	<ul style="list-style-type: none"> • Use microwave-safe cookware only. • Use correct cooking time, power level. • Turn or stir food.

18 MAINTENANCE

TROUBLESHOOTING GUIDE

If you have a problem you cannot solve, please do not hesi-tate to call our service line:

**Questions or for Service Call:
1-800-374-4432**

Before you call a repair person for your microwave, check the list below for possible easy solutions to some common problems.

Neither the microwave's display or oven operates -

Properly insert the plug into a grounded power outlet.

Remove the plug from the outlet, wait 10 seconds, then plug the microwave in again.

Check the household circuit breaker.

Plug the microwave into a different power outlet.

The oven display works, but the oven will not operate -

Make sure the oven door is closed securely and completely.

Check to see if packing material or other materials are stuck to the door seal.

Check for damage to the oven door. Contact service if dented.

Press the STOP pad twice and attempt to re-enter cooking instructions.

Plug the microwave into a different power outlet.

I cannot open the oven door -

Confirm the keypad lock is not active on the CANCEL button.

CANCEL
HOLD 3S TO
LOCK KEYPAD

The power goes off before the cook time has elapsed -

If there has been a power interruption, remove the plug from the outlet; wait 10 seconds, then plug the microwave in again. If there was a power outage, the time indicator in the display will show 00:00.

Reset the clock and any cooking instructions.

Check the household circuit breaker.

Press the STOP pad twice and attempt to re-enter cooking instructions.

Plug the microwave into a different power outlet.

Food is cooking too slowly -

Make sure the oven is on a separate 20 amp circuit line. Operating another appliance on the same circuit can cause a voltage drop.

You see sparks or arcing -

Remove any metallic utensils, cookware or metal ties from the oven cavity.

The turntable makes noises or sticks -

Clean the turntable, roller ring and oven cavity bottom.

Make sure the turntable and roller ring are positioned correctly.

Using your microwave causes TV or radio interference -

This is similar to the interference caused by other small appliances, such as hair dryers. Move your microwave further away from other appliances.

Please note: If the oven is set to cook for more than 30 minutes at 100% power level, it will automatically adjust itself to a 80% power level after 30 minutes to avoid overcooking.

CLEANING SUGGESTIONS

For best performance and for safety reasons, keep the oven clean inside and outside. Take special care to keep the inner door panel and oven frame free of food and grease buildup.

Never use rough scouring powder or pads on the microwave. Wipe the microwave oven inside and out with a soft cloth and warm (not hot) mild detergent solution. Then rinse and wipe completely dry.

Wipe splatters immediately with a wet paper towel, especially after cooking greasy foods like chicken or bacon.

Follow these instructions to clean and care for your microwave oven:

Keep the inside (cavity) of the oven clean. Food particles and spilled liquids can stick to the oven walls, causing the oven to work less efficiently.

Wipe up spills immediately. Use a damp, clean cloth and mild detergent. DO NOT use harsh detergents or abrasive cleaners.

To help loosen baked-on food particles or liquids, heat 2 cups of water (add the juice of 1 lemon if you desire to keep the oven smelling fresh) in a 4 cup measuring glass at High power for 5 minutes or until boiling. Let stand in oven cavity for 1 to 2 minutes.

Remove the glass turntable tray from the oven when cleaning the oven cavity or tray. To prevent the glass turntable from breaking, handle with care and do not put it in water immediately after cooking. Wash the turntable tray with mild detergent.

Clean the outside surface of the microwave with mild detergent and a clean damp cloth. Dry with a clean soft cloth. To prevent damage to the operating parts of the oven, do not let water seep into any vents or openings.

Wash the oven door window with very mild soap and water. Be sure to use a soft clean cloth to avoid scratching.

If steam accumulates inside or outside the oven door, wipe with a soft cloth. Steam can accumulate when operating the oven in high humidity and in no way indicates microwave leakage.

Never operate the oven without food in the oven cavity; this can damage the magnetron tube or glass tray.

20 SERVICE CALL CHECK

Please check the following before calling for service:

Place one cup of water in a glass measuring cup in the microwave oven and close the door securely. Operate the microwave oven for one minute at HIGH 100%.

- | | | | |
|---|--|----------|---------|
| A | Does the microwave oven light come on? | YES ____ | NO ____ |
| B | Does the cooling fan work? (Put your hand at top above Display.) | YES ____ | NO ____ |
| C | Does the turntable rotate? (It is normal for the turntable to turn in either direction.) | YES ____ | NO ____ |
| D | Is the water in the microwave oven warm? | YES ____ | NO ____ |

If “NO” is the answer to any of the above questions, please check electrical outlet, fuse and/or circuit breaker. If they are functioning properly, CONTACT YOUR NEAREST ELECTROLUX AUTHORIZED SER-VICER.

A microwave oven should never be serviced by a “do-it-yourself” repair person.

SPECIFICATIONS

AC Line Voltage:	Single phase 120VAC, 60Hz, AC only
Rated Input	1500W
Output Power*:	1100 W
Frequency:	2450 MHz
Outside Dimensions (including handle):	24.4 "x 19.8 "x 13.5 "
Cavity Dimensions:	19.1 "x 17.8 "x 11.2 "
Microwave oven Capacity***:	2.2 Cu.Ft.
Cooking Uniformity:	Turntable
Weight:	Approx.(net) 42.73 Lbs,(gross)48.12 Lbs
Oven Light:	1*1.5W LED,

* The International Electrotechnical Commission’s standardized method for measuring output wattage. method is widely recognized. test method

** This is the classification of ISM (Industrial, Scientific and Medical) equipment described in the International Standard CISPR11.

*** Internal capacity is calculated by measuring maximum width, depth and height. Actual capacity for holding food is less. In compliance with standards set by:

FCC - Federal Communications Commission Authorized.

DHHS - Complies with Department of Health and Human Services (DHHS) rule, CFR, Title 21, Chapter I, Subchapter J.



- This symbol on the nameplate means the product is listed by Underwriters Laboratories, Inc.



- This symbol on the nameplate means the product is listed by Underwriters Laboratories, Inc. for use in USA or Canada.

Your appliance is covered by a one year limited warranty. For one year from your original date of purchase, Electrolux will pay all costs for repairing or replacing any parts of this appliance that prove to be defective in materials or workmanship when such appliance is installed, used and maintained in accordance with the provided instructions.

Exclusions

This warranty does not cover the following:

1. Products with original serial numbers that have been removed, altered or cannot be readily determined.
2. Product that has been transferred from its original owner to another party or removed outside the USA or Canada.
3. Rust on the interior or exterior of the unit.
4. Products purchased "as-is" are not covered by this warranty.
5. Food loss due to any refrigerator or freezer failures.
6. Products used in a commercial setting.
7. Service calls which do not involve malfunction or defects in materials or workmanship, or for appliances not in ordinary household use or used other than in accordance with the provided instructions.
8. Service calls to correct the installation of your appliance or to instruct you how to use your appliance.
9. Expenses for making the appliance accessible for servicing, such as removal of trim, cupboards, shelves, etc., which are not a part of the appliance when it is shipped from the factory.
10. Service calls to repair or replace appliance light bulbs, air filters, water filters, other consumables, or knobs, handles, or other cosmetic parts.
11. Surcharges including, but not limited to, any after hour, weekend, or holiday service calls, tolls, ferry trip charges, or mileage expense for service calls to remote areas, including the state of Alaska.
12. Damages to the finish of appliance or home incurred during installation, including but not limited to floors, cabinets, walls, etc.
13. Damages caused by: services performed by unauthorized service companies; use of parts other than genuine Electrolux parts or parts obtained from persons other than authorized service companies; or external causes such as abuse, misuse, inadequate power supply, accidents, fires, or acts of God.

DISCLAIMER OF IMPLIED WARRANTIES; LIMITATION OF REMEDIES

CUSTOMER'S SOLE AND EXCLUSIVE REMEDY UNDER THIS LIMITED WARRANTY SHALL BE PRODUCT REPAIR OR REPLACEMENT AS PROVIDED HEREIN. CLAIMS BASED ON IMPLIED WARRANTIES, INCLUDING WARRANTIES OF MERCHANTABILITY OR FITNESS FOR A PARTICULAR PURPOSE, ARE LIMITED TO ONE YEAR OR THE SHORTEST PERIOD ALLOWED BY LAW, BUT NOT LESS THAN ONE YEAR. ELECTROLUX SHALL NOT BE LIABLE FOR CONSEQUENTIAL OR INCIDENTAL DAMAGES SUCH AS PROPERTY DAMAGE AND INCIDENTAL EXPENSES RESULTING FROM ANY BREACH OF THIS WRITTEN LIMITED WARRANTY OR ANY IMPLIED WARRANTY. SOME STATES AND PROVINCES DO NOT ALLOW THE EXCLUSION OR LIMITATION OF INCIDENTAL OR CONSEQUENTIAL DAMAGES, OR LIMITATIONS ON THE DURATION OF IMPLIED WARRANTIES, SO THESE LIMITATIONS OR EXCLUSIONS MAY NOT APPLY TO YOU. THIS WRITTEN WARRANTY GIVES YOU SPECIFIC LEGAL RIGHTS. YOU MAY ALSO HAVE OTHER RIGHTS THAT VARY FROM STATE TO STATE.

If You Need Service

Keep your receipt, delivery slip, or some other appropriate payment record to establish the warranty period should service be required. If service is performed, it is in your best interest to obtain and keep all receipts. Service under this warranty must be obtained by contacting Electrolux at the addresses or phone numbers below.

This warranty only applies in the USA and Canada. In the USA, your appliance is warranted by Electrolux Major Appliances North America, a division of Electrolux Home Products, Inc. In Canada, your appliance is warranted by Electrolux Canada Corp. Electrolux authorizes no person to change or add to any obligations under this warranty. Obligations for service and parts under this warranty must be performed by Electrolux or an authorized service company. Product features or specifications as described or illustrated are subject to change without notice.

USA

1-800-374-4432

Electrolux Home Products,
Inc., 10200 David Taylor
Drive Charlotte, NC 28262



Electrolux

Canada

1.800.265.8352

Electrolux Canada Corp.
5855 Terry Fox Way
Mississauga, Ontario, Canada

L5V 3E4

Printed in China

FRIGIDAIRE®

welcome *home*

Our home is your home. Visit us if you need help with any of these things:



owner support



accessories



service



registration

(See your registration card for more information.)

Frigidaire.com
1-800-374-4432

Frigidaire.ca
1-800-265-8352