

DUEL FUEL RANGE

use & care

Introduction 2
Important Safety Instructions 3
Cooking Recommendation 10
Before Setting Surface Controls 14
Setting Surface Controls 17

Before Setting Oven Controls 20
Setting Oven Controls 26
Care and Cleaning 48
Before You Call 54
Warranty 58

2

INTRODUCTION

Welcome to our **family**

Thank you for bringing Frigidaire into your home! We see your purchase as the beginning of a long relationship together.

This manual is your resource for the use and care of your product. Please read it before using your appliance. Keep it handy for quick reference. If something doesn't seem right, the troubleshooting section will help you with common issues.

FAQs, helpful tips and videos, cleaning products, and kitchen and home accessories are available at www.frigidaire.com.

We are here for you! Visit our website, chat with an agent, or call us if you need help. We may be able to help you avoid a service visit. If you do need service, we can get that started for you.

Let's make it official! Be sure to register your product.

Keep your product info here so it's easy to find.

Model Number: _____

Serial Number: _____

Purchase Date: _____

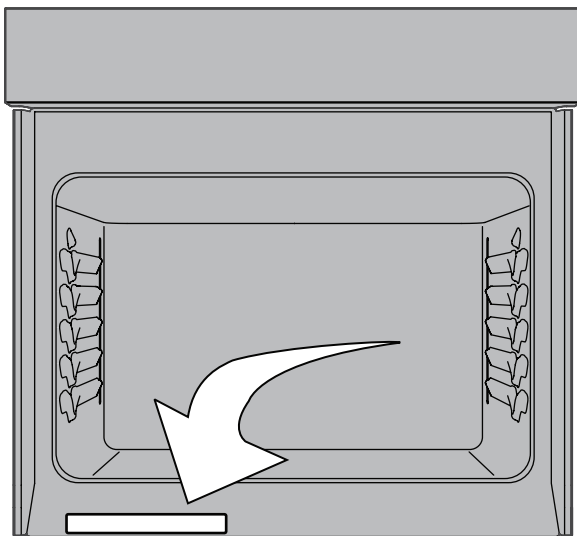

Serial Number Location

✓ Installation Checklist

Doors

- Handles are secure and tight.
- Door seals completely to cabinet on all sides.

Leveling

- Range is level side-to-side and front-to back.
- Cabinet is setting solid on all corners.

Electrical power

- House power turned in.
- Range wired or plugged in.

Final checks

- Shipping material removed.
- Registration card sent in.

Read all instructions before using this appliance.

This manual contains important safety symbols and instructions. Please pay attention to these symbols and follow all instructions given.

Do not attempt to install or operate your appliance until you have read the safety precautions in this manual. Safety items throughout this manual are labeled with a WARNING or CAUTION statement based on the risk type.

Warnings and important instructions appearing in this guide are not meant to cover all possible conditions and situations that may occur. Common sense, caution, and care must be exercised with installing, maintaining, or operating your appliance.

DEFINITIONS

 This is the safety alert symbol. It is used to alert of potential personal injury hazards. Obey all safety messages that follow this symbol to avoid possible injury or death.

WARNING

Indicates a potentially hazardous situation which, if not avoided, may result in death or serious injury.

CAUTION

Indicates a potentially hazardous situation which, if not avoided, may result in minor or moderate injury.

IMPORTANT

Indicates installation, operation or maintenance information which is important but not hazard-related.

NOTE

Indicates a short, informal reference – something written down to assist the memory or for future reference.

⚠ WARNING If the information in this manual is not followed exactly, a fire or explosion may result causing property damage, personal injury or death.

FOR YOUR SAFETY:

- Do not store or use gasoline or other flammable vapors and liquids in the vicinity of this or any other appliance.
- WHAT TO DO IF YOU SMELL GAS:
 - Do not try to light any appliance.
 - Do not touch any electrical switch; do not use any phone in your building.
 - Immediately call your gas supplier from a neighbor's phone. Follow the gas supplier's instructions.
 - If you cannot reach your gas supplier, call the fire department.
- Installation and service must be performed by a qualified installer, servicer or the gas supplier.

WARNING

Never operate the top surface cooking section of this appliance unattended.

- Failure to follow this warning statement could result in fire, explosion, or burn hazard that could cause property damage, personal injury, or death.
- If a fire should occur, keep away from the appliance and immediately call your fire department.

DO NOT ATTEMPT TO EXTINGUISH AN OIL/GREASE FIRE WITH WATER.

4

IMPORTANT SAFETY INSTRUCTIONS

⚠ WARNING

Tip Over Hazard

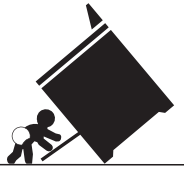

- A child or adult can tip the range and be killed.
- Verify the anti-tip device has been installed to floor or wall.

- Ensure the anti-tip device is re-engaged to floor or wall when the range is moved.
- Do not operate the range without the anti-tip device in place and engaged.
- Failure to follow these instructions can result in death or serious burns to children and adults.

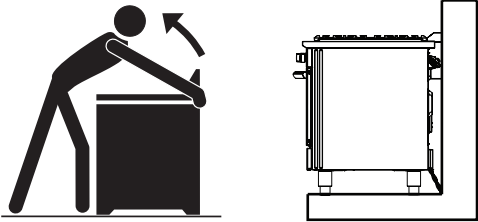

To check if the anti-tip device is installed properly, use both arms to grasp the rear edge of the range back. Carefully attempt to tilt range forward. When properly installed, the range should not tilt forward.

Refer to the anti-tip installation instructions supplied with your range for proper installation.

IMPORTANT INSTRUCTIONS FOR UNPACKING AND INSTALLATION

➔ IMPORTANT

Read and follow the below instructions and precautions for unpacking, installing, and servicing your appliance.

Remove all tape and packaging before using the appliance. Destroy the carton and plastic bags after unpacking the appliance. Never allow children to play with packaging material. Do not remove the wiring label and other literature attached to the appliance. Do not remove model/serial number plate.

Cold temperatures can damage the electronic control. When using this appliance for the first time, or when the appliance has not been used for an extended period of time, be sure the appliance has been in temperatures above 32°F (0°C) for at least 3 hours before turning on the power to the appliance.

All materials used in construction of cabinets, enclosures, and supports surrounding the product must have a temperature rating above 200°F (94°C).

Never modify or alter the construction of the appliance by removing the leveling legs, panels, wire covers, anti-tip device, or any other part of the appliance.

Be sure to have an appropriate foam-type fire extinguisher available, visible, and easily accessible located near the appliance.

⚠ WARNING

Air curtain or other overhead range hoods that operate by blowing a downward air flow onto a range or cooktop shall not be used in conjunction with gas ranges or cooktops other than when the range or cooktop and hood have been designed, tested, and listed by an independent test laboratory for use in combination with each other.

GROUNDING INSTRUCTIONS**WARNING**

- Avoid fire hazard or electrical shock. Failure to follow this warning may cause serious injury, fire, or death.
- Avoid fire hazard or electrical shock. Do not use an adapter plug or use an extension cord. Failure to follow this warning may cause serious injury, fire, or death.

Proper Installation—Be sure your appliance is properly installed and grounded by a qualified technician. In the United States, install in accordance with the National Fuel Gas Code ANSI Z223.1/NPFA No. 54, latest edition and National Electrical Code NFPA No. 70 latest edition, and local electrical code requirements. In Canada, install in accordance with CAN/CGA B149.1 and CAN/CGA B149.2 and CSA Standard C22.1, Canadian Electrical code, Part 1-latest editions and local electrical code requirements. Install only per installation instructions provided in the literature package for this appliance.

For personal safety, this appliance must be properly grounded. For maximum safety, the power cord must be securely connected to an electrical outlet or junction box that is the correct voltage, is correctly polarized and properly grounded, and protected by a circuit breaker in accordance with local codes.

It is the personal responsibility of the consumer to have the appropriate outlet or junction box with the correct, properly grounded wall receptacle installed by a qualified electrician. It is the responsibility and obligation of the consumer to contact a qualified installer to assure that the electrical installation is adequate and is in conformance with all local codes and ordinances.

For personal safety, the appliance must be properly grounded. For maximum safety, the power cord must be plugged into an electrical outlet that is correctly polarized and properly grounded.

6

IMPORTANT SAFETY INSTRUCTIONS

Conversion to (L.P.) Gas

This appliance allows for conversion to Liquefied Petroleum (L.P.) gas.

WARNING

Personal injury or death from electrical shock may occur if the conversion to L.P. gas is not made by a qualified installer or electrician. Any additions, changes or conversions required in order for this appliance to satisfactorily meet the application needs must be made by a qualified technician.

If L.P. conversion is needed, contact your local L.P. gas provider for assistance.

See the installation instructions packaged with this appliance for complete installation and grounding instructions.

IMPORTANT INSTRUCTIONS FOR USING THE APPLIANCE

WARNING

- Storage In or On Appliance—Flammable materials should not be stored in an oven or microwave, near surface burners or elements, or in the storage or warmer drawer (if equipped). This includes paper, plastic, and cloth items, such as cookbooks, plastic ware, and towels, as well as flammable liquids. Do not store explosives, such as aerosol cans, on or near the appliance.

WARNING

- Do not leave children alone - Children should not be left alone or unattended in the area where appliance is in use. They should never be allowed to sit or stand on any part of the appliance, including the storage drawer, lower broiler drawer, warmer drawer, or lower double oven.
- Do not store items of interest to children in the cabinets above the appliance or on the backguards of ranges. Children climbing on or near the appliance to reach items could be seriously injured.
- Do not allow children to climb or play around the appliance. The weight of a child on an open oven door may cause the appliance to tip, resulting in serious burns or other injury. An open drawer when hot may cause burns.
- Stepping, leaning, or sitting on the door or drawers of this appliance can result in serious injuries and also cause damage to the appliance.
- Never cover any slots, holes or passages in the oven bottom or cover and entire rack with materials such as aluminum foil. Doing so blocks air flow through the oven and may cause carbon monoxide poisoning. Aluminum foil linings may also trap heat, causing a fire hazard.
- Do not use oven or warmer drawer (if equipped) for storage.
- Never use your appliance as a space heater to heat or warm the room. Doing so may result in carbon monoxide poisoning and overheating of the appliance.

! CAUTION

- When heating fat or grease, watch it closely. Grease may catch fire if it becomes too hot.
- Do not use water or flour on grease fires. Smother fire or flame or use dry chemical or foam-type extinguisher. Cover the fire with a pan lid or use baking soda.
- Use dry potholders. Moist or damp potholders on hot surfaces may result in burns from steam. Do not let potholders touch hot cooking areas. Do not use towels or other bulky cloths.
- Do not heat unopened food containers; build-up of pressure may cause container to burst and result in injury.
- Wear proper apparel - Loose-fitting or hanging garments should never be worn while using the appliance. Do not let clothing or other flammable materials contact hot surfaces.
- Do not touch surface burners or elements, areas near these burners or elements, interior surfaces of the oven, or the warmer drawer (if equipped). Surface burners and elements may be hot even though they appear cool. Areas near surface burners and elements may become hot enough to cause burns. During and after use, do not touch, or let clothing or other flammable materials touch these areas until they are cool. These areas may include the cooktop, surfaces facing the cooktop, oven vent areas, oven door, and oven window.

! CAUTION

- Do not attempt to operate the appliance during a power failure. If the power fails, always turn off the appliance. If the appliance is not turned off and the power resumes, electric surface elements may resume operation when power is restored. Once the power resumes, reset the clock and the oven function.

IMPORTANT INSTRUCTIONS FOR USING YOUR GAS COOKTOP

! CAUTION

Use Proper Flame Size — Adjust flame size so it does not extend beyond the edge of the utensil. The use of undersized utensils will expose a portion of the burner flame to direct contact and may result in ignition of clothing. Proper relationship of utensil to flame will also improve efficiency.

Know which knob or key controls each surface heating area. Place cookware with food on the cooking area before turning it on. Turn the cooking area off before removing the cookware.

Use proper pan size. This appliance is equipped with one or more surface units of different sizes. Select cookware with flat bottoms that match the surface unit heating element. The use of undersized cookware may expose a portion of the flame to direct contact and may result in the ignition of clothing or other items. Using the proper cookware on the cooking areas will improve efficiency.

Always turn knob to the full LITE position when igniting top burners. Visually check that burner has lit. Then adjust the flame so it does not extend beyond the edge of the utensil.

8

IMPORTANT SAFETY INSTRUCTIONS

To reduce the risk of burns, ignition of flammable materials, and spillage due to unintentional contact with the utensil, the handle of the utensil should be positioned so that it is turned inward, and does not extend over adjacent surface burners

Never leave surface burners unattended at high heat settings — Boil overs cause smoking and greasy spill overs that may ignite, or a pan that has boiled dry may melt.

Glazed cooking utensils — Only certain types of glass, glass/ceramic, ceramic, earthenware, or other glazed utensils are suitable for cooktop service without breaking due to the sudden change in temperature. Check the manufacturer's recommendations for cooktop use.

When you are flaming foods under a ventilating hood, turn the fan on.

IMPORTANT INSTRUCTIONS FOR USING YOUR OVEN

Protective liners—Do not use aluminum foil, aftermarket oven liners, or any other materials or devices to line oven bottom, oven racks, or any other part of the appliance. Only use aluminum as recommended for baking, such as lining cookware or as a cover placed on food. Any other use of protective liners or aluminum foil may result in a risk of electric shock or fire or a short circuit.

Use care when opening oven door, lower oven door, or warmer drawer (some models). Stand to the side of the appliance when opening the door of a hot oven. Let hot air or steam escape before you remove or replace food in the oven.

Keep oven vent ducts unobstructed. Touching surfaces in this area when the oven is on may cause severe burns. Do not place plastic or heat-sensitive items on or near the oven vent. These items can melt or ignite.

Placement of oven racks - Always place oven racks in desired location while oven is cool. If rack must be moved while oven is hot, do not let potholder contact hot burner or element in oven. Use potholders and grasp the rack with both hands to reposition. Remove all cookware and utensils before moving the rack.

Do not use a broiler pan without its insert. Broiler pans and inserts allow dripping fat to drain away from the high heat of the broiler. Do not cover the broiler insert with aluminum foil; exposed fat and grease could ignite.

Do not cook food on the oven bottom. Always cook in proper cookware and always use the oven racks.

IMPORTANT INSTRUCTIONS FOR CLEANING YOUR APPLIANCE

CAUTION

Before manually cleaning any part of the appliance, be sure all controls are turned off and the appliance is cool. Cleaning a hot appliance can cause burns.

Clean the appliance regularly to keep all parts free of grease that could catch fire. Do not allow grease to accumulate. Greasy deposits in the fan could catch fire.

Always follow the manufacturer's recommended directions for use of kitchen cleaners and aerosols. Be aware that excess residue from cleaners and aerosols may ignite causing damage and injury.

Clean ventilating hoods frequently - Grease should not be allowed to accumulate on hood or filter. Follow the manufacturer's instructions for cleaning vent hoods.

IMPORTANT INSTRUCTIONS FOR SELF CLEANING OVENS**CAUTION**

Before using self clean, remove the broiler pan, any food, utensils, and cookware from the oven, storage drawer or warming drawer (if equipped). Remove oven racks unless otherwise instructed.

Do not clean the oven door gasket. The door gasket is essential for a good seal. Care should be taken not to rub, damage, or move the gasket.

Do not use a protective coating to line the oven and do not use commercial oven cleaner unless certified for use in a self-cleaning oven. Always follow the manufacturer's directions for use of cleaners.

Use the self clean cycle to clean only the parts listed in this manual.

Some birds are extremely sensitive to the fumes given off during the self clean cycle of any oven. Move birds to another well-ventilated room.

IMPORTANT INSTRUCTIONS FOR SERVICE AND MAINTENANCE

Do not repair or replace any part of the appliance unless specifically recommended in the manuals. All other servicing should be done only by a qualified technician. This reduces the risk of personal injury and damage to the appliance.

Always contact your dealer, distributor, service agent, or manufacturer about problems or conditions you do not understand.

Ask your dealer to recommend a qualified technician and an authorized repair service. Know how to disconnect the power to the appliance at the circuit breaker or fuse box in case of an emergency.

Remove the oven door from any unused oven if it is to be stored or discarded.

Do not touch a hot oven light bulb with a damp cloth. Doing so could cause the bulb to break. Handle halogen lights (if equipped) with paper towels or soft gloves. Disconnect the appliance or shut off the power to the appliance before removing and replacing the bulb.

**WARNING**

California Residents: for cancer and reproductive harm information, visit www.P65Warnings.ca.gov

10 COOKING RECOMMENDATION



Special Features

Use the special features of your Frigidaire oven to get the best baking and roasting results.

Goal	Feature
<ul style="list-style-type: none">Breads and pastries that rise higher with a crispy, golden crust and a light, flaky interior	Steam Bake Steam baking slows the formation of the crust, allowing your dough to grow longer before the crust forms.
<ul style="list-style-type: none">Moist and tender meats with a golden, crispy skin on the outside.	Steam Roast The humidity of steam roasting prevents meats from drying out during the cooking process.
<ul style="list-style-type: none">Golden, crispy chicken wingsCrunchy vegetable chipsJuicy chicken parmesanPerfectly crisp tempura shrimp, samosas, and more	Air Fry The hot air convection makes crisp, golden fried foods without the splatter. For even heating on all sides and large capacity, use the Air Fry Tray .
<ul style="list-style-type: none">Healthy, flavorful fruit snacksLean meat jerkyDried herbs	Dehydrate The dehydrate feature keeps the oven on low humidity and low heat to dry foods without cooking them.
<ul style="list-style-type: none">Airy breads and balanced pizza dough	Bread Proof Bread proofing keeps your oven at the best temperature and humidity for yeast to cause your dough to rise.
<ul style="list-style-type: none">Perfectly browned baked goodsEvenly cooked roasts and braises	Convection Cooking Even your most challenging recipes turn out delicious with the precisely-controlled heat and air circulation of Advanced Convection
<ul style="list-style-type: none">Prevent build-up of burned, spilled food in the bottom of the oven	Steam Clean Keep your oven looking its best with the Steam Clean cycle that's chemical- and odor-free
<ul style="list-style-type: none">Roast turkey that's crispy on the outside and juicy on the inside.	Turkey Option Precisely times your convection roast for turkey that is perfectly done.

Bakeware

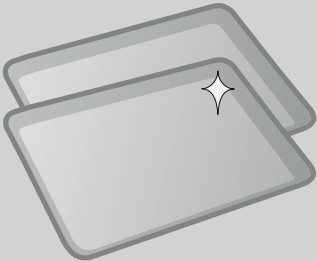
The material of bakeware affects how evenly and quickly it transfers heat from the pan to the food.

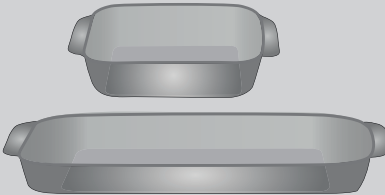
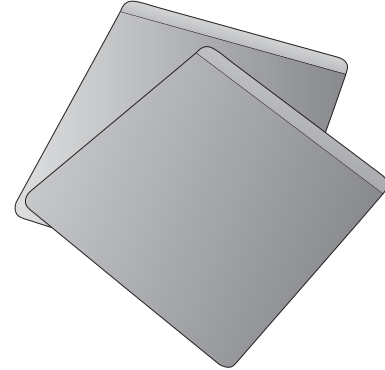
Material	Attributes	Recommendation
<p>Shiny metal bakeware</p> 	<p>Shiny, aluminum, and non-coated bakeware is the best for even heating. It is suitable for all baked goods.</p>	<p>Recommended cooking temperatures and times are based on shiny metal bakeware.</p>
<p>Dark metal bakeware</p> 	<p>Dark bakeware cooks hotter than shiny bakeware.</p>	<p>Reduce the cooking temperature by 25°F (13-14°C) when using dark bakeware.</p>
<p>Glass bakeware</p> 	<p>Glass bakeware cooks hotter than shiny bakeware.</p> <p>Glass is convenient, as the same piece of bakeware can be used for cooking, serving, and storing food.</p>	<p>Reduce the cooking temperature by 25°F (13-14°C) when using glass bakeware.</p>
<p>Insulated bakeware</p> 	<p>Insulated bakeware cooks cooler than shiny bakeware.</p> <p>Insulated bakeware is designed for baking in gas ovens.</p>	<p>When using insulated bakeware, the recipe baking time may be longer than usual.</p>

12 COOKING RECOMMENDATION

Cooking Conditions

Conditions in your kitchen can affect the performance of your appliance when cooking food.

Condition	Attributes	Recommendation
Aging cookware	As pans age and become discolored, cooking times may need to be reduced slightly.	If food is too dark or overcooked, use the minimum cook time in the recipe or packaging. If food is too light or undercooked, use the middle to maximum cook time in the recipe or packaging.
High altitude	Air is drier and air pressure is lower. Water boils at a lower temperature, and liquids evaporate faster. Foods may take longer to bake. Doughs may rise faster.	Adjust cooking temperature, cooking time, or recipes as needed. Increase amount of liquid in baking recipes. Increase cook time on cooktop. Cover dishes to reduce evaporation. Increase bake time or oven temperature. Reduce amount of baking soda or baking powder in recipe. Reduce rising time or punch down dough and allow it to rise twice.

Cooking Results

Small adjustments may help you achieve the best results.

Result	Recommendation
Food too light	Use the middle to maximum cook time recommended on packaging or recipe.
Food too dark	Use the minimum cook time recommended on packaging or recipe.

Cooking Tips

Use these additional tips to get the best results from your appliance.

Situation	Recommendation
Baking	
Rack placement	Follow the instructions in particular oven mode starting in "Setting Oven Controls" on page 26.
Preheat	Fully preheat the oven before baking items like cookies, cakes, biscuits, and breads. Insert food immediately after the beep.
Checking food	Use the window and oven light when checking food. Opening the door may reduce baking performance.
Bake or Convection Bake	Convection bake is the best function to use for baking on multiple racks. For best performance, see "Convection Bake" on page 30.
Steam Bake	For directions, tips, and benefits of Steam Bake see "Steam Bake" on page 38.
Food placement	Allow at least 2 inches (5 cm) of space between bakeware for proper air circulation.

Material	Recommendation
Broiling / Roasting	
Broil pan	For best results when broiling, use a broil pan with an insert designed to drain the fat from the food, help avoid spatter, and reduce smoking. The broil pan will catch grease spills, and the insert helps prevent grease splatters. To purchase the broil pan go to https://www.frigidaire.com/
Convection Cooking	
Convection attributes	<p>Convection cooking uses a fan to circulate hot air around the oven and food. It browns food more evenly and reduces hot spots in the oven.</p> <p>Convection saves time when using multiple racks or cooking several food items at once.</p>
Convection bake	<p>Reduce cooking temperature by 25°F (13-14°C) from the recipe unless the recipe is written for convection baking.</p> <p>Preheat the oven for best results.</p>
Convection roast	<p>Convection roast is best for meats and does not require preheating for most meats and poultry.</p> <p>Reducing the cooking temperature for convection roast is not recommended. Carefully follow your recipe's temperature and time recommendations, adjusting the cooking time if the recipe does not specify convection roasting time.</p> <p>Since convection roast cooks faster, cook time may be reduced by 25% to 40% depending on food type. You can reduce cook times by 25% from the recommended time of your recipe, and check the food at this time. If needed, continue cooking until the desired doneness is obtained.</p> <p>Arrange oven racks so large cuts of meat and poultry are on the lowest rack of the oven.</p> <p>Do not cover foods when dry roasting - covering will prevent the meat from browning properly.</p> <p>When cooking meats, use the broiler pan and insert or a roasting rack. The broiler pan will catch grease spills and the insert helps prevent grease splatters.</p>

14

BEFORE SETTING SURFACE CONTROLS

Gas surface burner types

The cooktop is equipped with gas surface burners with different BTU ratings. The ability to heat food quickly and in large amounts increases as the burner size increases.

- Small burners are best used for low-flame heating of small amounts of food.
- Standard burners can be used for most surface cooking needs.
- The largest burner is best used for bringing large quantities of liquid rapidly up to temperature or when preparing larger quantities of food. The large burner is located at the right front position on the cooktop.

Regardless of size, always select cookware that is suitable for the amount and type of food being prepared. Select a burner and set the flame size appropriately for the pan. Never allow flames to extend beyond the outer edge of the pan.

Assembly of the Burner

Remove all packing material from the cooktop area.

Make sure the burner cup (or the burner head, for single burner) fits correctly over the burner base. The mark on the burner cup should point towards the ignitor.

Note: Duel burner operates with two nozzles. While assembling the burner cup, make sure the nozzles on the burner base are aligned with holes in the burner cup.

Make sure that all of the surface burner caps and surface burner grates are installed correctly and at the correct locations.

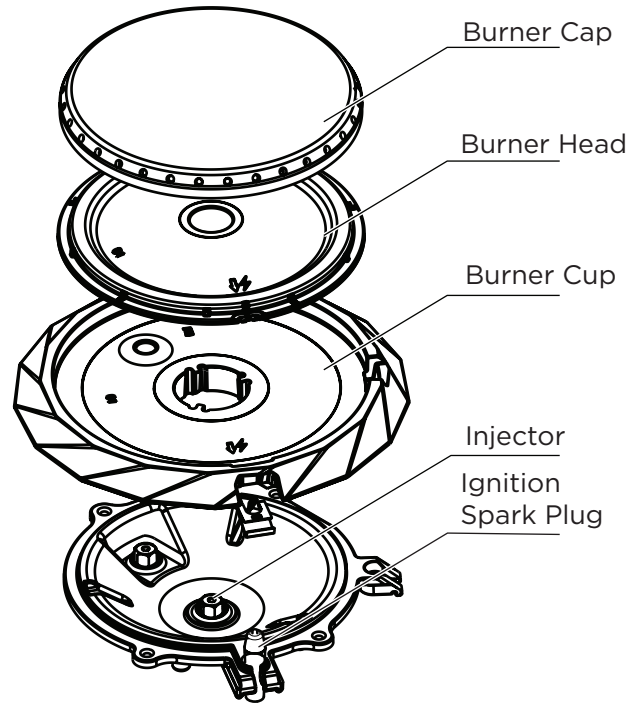

Figure 1: Duel Burner Assembly

Important: The burner cup has a hole which fits over the ignitor. Make sure the burner cup fits snugly before placing the burner head and cap.

Note: Unpack the burner grates and position them on the cooktop after the burner heads and caps are properly installed.

NOTE

This product comes with two types of burners.

- Duel burner: Located at front right and front left of the cooktop, it comes with a 3 piece assembly (burner cup, burner head and burner cap).
- Single burner: All other burners on the cooktop are single burners, and come with 2 piece assembly (burner head and burner cap).

Once in place, you may check the fit by gently sliding the burner cap from side to side (Figure 2) to be sure it is centered and firmly seated. When the burner cap lip makes contact inside the center of the burner head you will be able to hear the burner cap click.

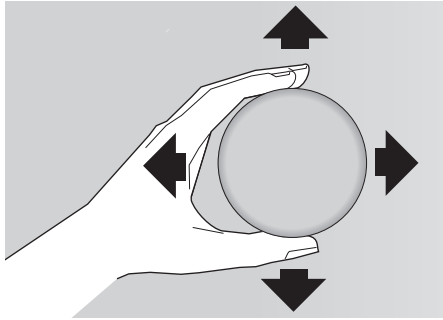

Figure 2: Gently move cap for proper placement

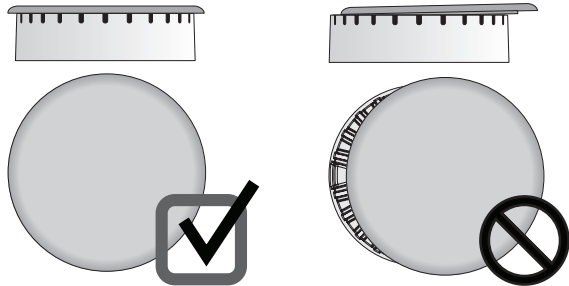

Figure 3: Proper burner cap placement

CAUTION

- Do not allow spills, food, cleaning agents, or any other material to enter the gas orifice holder opening.
- Always keep the burner caps and burner heads in place whenever the surface burners are in use.
- Never place flammable items on the cooktop.

Install Burner Grates

Install the middle grate first by aligning the grate with the burner and gently placing the grate on hob.

The rubber feet on the trivets locate into the contours of the hob.

The middle grate is designed to guide the location of the side grates. Gently place the side grates in the orientation shown.

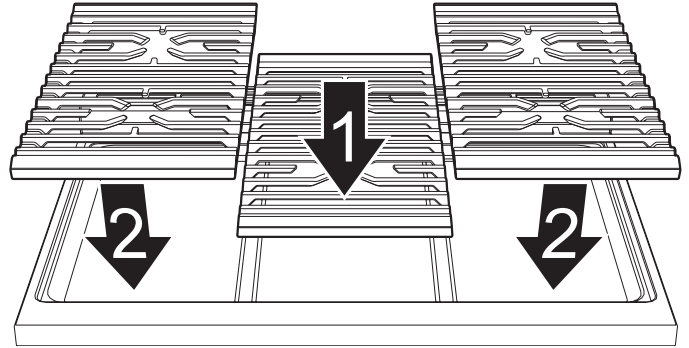

Figure 4: Grate installation

IMPORTANT

- Make sure the burner grates are properly placed on the cooktop before using the surface burners (Figure 4). The grates are designed to rest inside the recess on the cooktop.
- Grates should rest flush against each other and against the sides of the recess.
- Do not line the area underneath the grates or any part of the cooktop with aluminum foil or with any other lining.

16 BEFORE SETTING SURFACE CONTROLS

Using Proper Cookware

The size and type of cookware used will influence the heat setting needed for best cooking results. Be sure to follow the recommendations for using proper cookware as illustrated in “Figure 5: Testing cookware” and “Figure 6: Proper cookware”.

Check for flatness by rotating a ruler across the bottom of the cookware (see “Figure 5: Testing cookware”). Cookware should have flat bottoms that make good contact with the entire surface of the heating element.

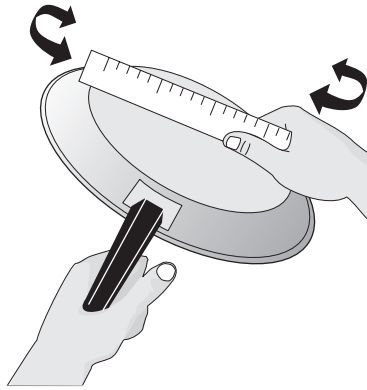

Figure 5: Testing cookware

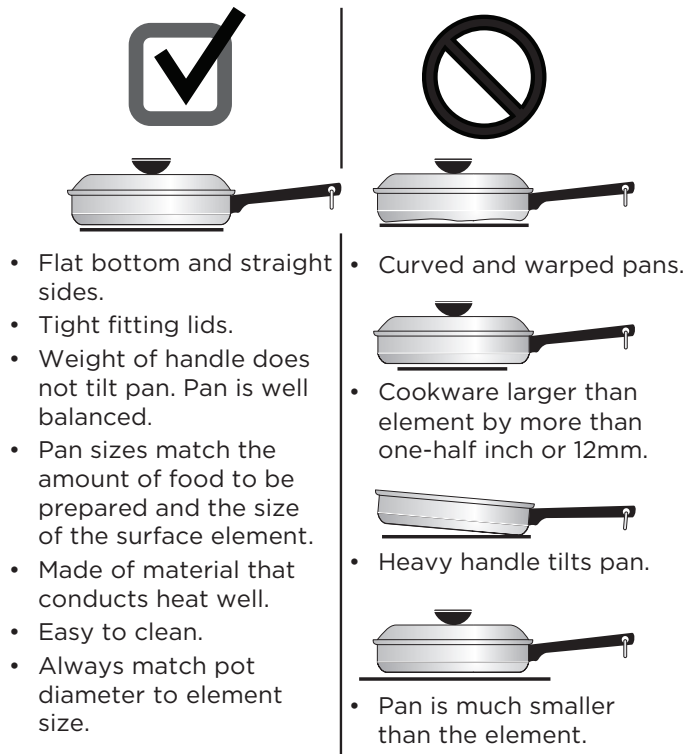

Figure 6: Proper cookware

Cookware Material Types

The cookware material determines how evenly and quickly heat is transferred from the surface element to the pan bottom. The most popular materials available are:

- **Aluminum** - Excellent heat conductor. Some types of food will cause it to darken (Anodized aluminum cookware resists staining and pitting).
- **Copper** - Excellent heat conductor but discolors easily (see Aluminum).
- **Stainless** - Slow heat conductor with uneven cooking results. Durable, easy to clean, and resists staining.
- **Cast Iron** - A slow heat conductor, but will retain heat very well. Cooks evenly once cooking temperature is reached.
- **Porcelain-enamel on metal** - Heating characteristics will vary depending on base material.
- **Glass** - Slow heat conductor.

IMPORTANT

Do not place empty aluminum, glass, or porcelain-enamel coated cookware on the element. The melting point of cookware made with these materials may be reached quickly, especially if left empty. If the cookware melts it will damage the cooktop. Follow all the cookware manufacturer's recommendations for use and care of cookware.

IMPORTANT

NEVER place or straddle a cooking utensil over two different surface cooking areas at the same time. Incorrect use may damage the cooktop.

Location of the Surface Burners

The ability to heat food quickly and in large volumes increases as the burner size increases. Your gas appliance may be equipped with many different sized surface burners.

It is important to select cookware that is suitable for the amount and type of food being prepared. Select a burner and flame size appropriate for the cookware size.

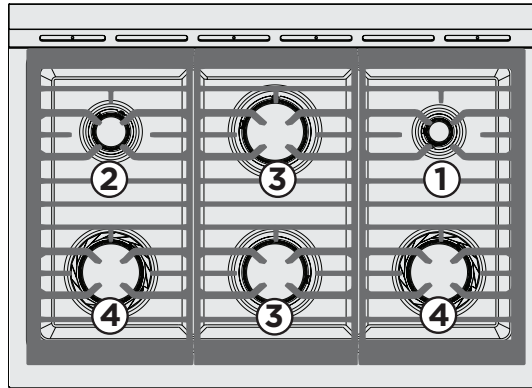

1. Small burner is best used for low-flame heating of small amounts of food.
2. Medium size burner may be used for most surface cooking needs with mid size cookware items.
3. Large burners are best for bringing large quantities of liquid to temperature or heating larger quantities of food.
4. Largest burners can be used for very fast heating and large size cookware items.

Control Panel

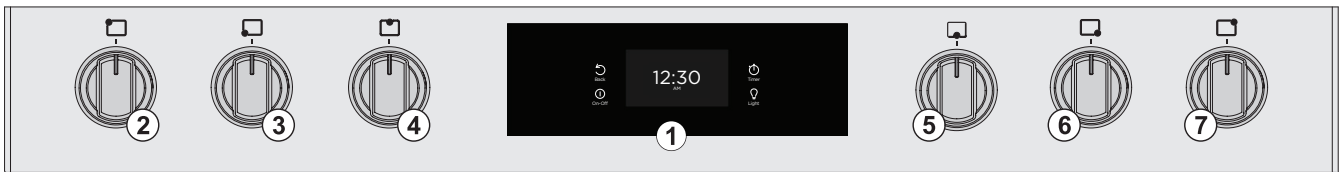

1. Oven Display
2. Cooktop Burner Knob (Rear Left)
3. Cooktop Burner Knob (Front Left)
4. Cooktop Burner Knob (Rear Center)
5. Cooktop Burner Knob (Front Center)
6. Cooktop Burner Knob (Front Right)
7. Cooktop Burner Knob (Rear Right)

18 SETTING SURFACE CONTROLS

Setting a surface burner:

1. Place cooking utensil on center of surface burner grate. Be sure the cooking utensil rests stable on the burner grate.
2. Push the burner's surface control knob in and turn counter clockwise to the "🔥" lite position (Figure 7).
3. Release the surface control knob once the flame is established. Visually check that the burner has a steady gas flame.
4. Once the surface burner has a flame, turn the surface control knob counter clockwise to the desired flame size setting. Adjust the flame as needed using the knob markings.

NOTE: If the flame goes out when knob is released, simply depress the knob and hold it down for approximately 5 seconds.

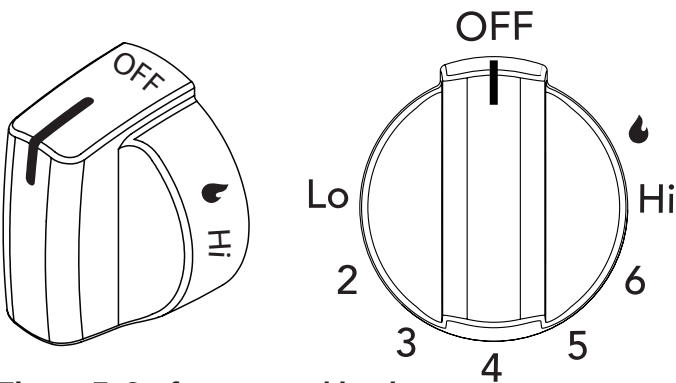

Figure 7: Surface control knob

CAUTION

Do not place flammable items such as plastic wrappings, spoon holders, or plastic salt and pepper shakers on the cooktop when it is in use. These items could melt or ignite. Potholders, towels, or wooden spoons could catch fire if placed too close to the surface burners.

NOTE

In the event of an electrical power outage, the surface burners may be lit manually. To light a surface burner, hold a lit match to the burner head, then push in and turn the surface control knob to lite position. Once the burner ignites, slowly turn knob out of lite then to the desired flame setting. Use caution when lighting surface burners manually.

Set proper burner flame size

The color of the flame is the key to proper burner adjustment. A good flame is clear, blue and hardly visible in a well-lighted room. Each cone of flame should be steady and sharp. Adjust or clean the burner if flame is yellow-orange.

For most cooking: start on the highest setting and then turn to a lower setting to complete the process. Use the recommendations below as a guide for determining proper flame size for various types of cooking (Table 1).

For deep fat frying: use a thermometer and adjust the surface knob accordingly. If the fat is too cool, the food will absorb the fat and be greasy. If the fat is too hot, the food will brown so quickly that the center will be under-cooked. Do not attempt to deep fat fry too much food at once as the food will neither brown nor cook properly.

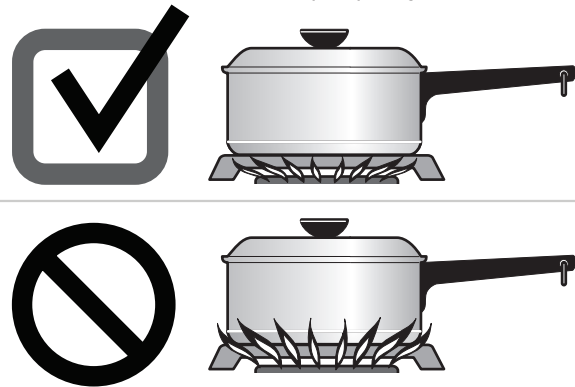

Figure 8: Proper burner flame

Flame size	Type of cooking
High flame	Start most foods; bring water to a boil; pan broiling
Medium flame	Maintain a slow boil; thicken sauces, gravies; steaming
Low flame	Keep foods cooking; poaching; stewing

These settings are based on medium-weight metal or aluminum pans with lids. Settings may vary when using other types of pans.

Table 1: Recommended flame settings for cooking

CAUTION

Never extend the flame beyond the outer edge of the cooking utensil. A higher flame wastes energy, and increases your risk of being burned by the flame (Figure 8).

Home Canning

Be sure to read and observe all the following points when home canning with your appliance. Check with the USDA (United States Department of Agriculture) website and be sure to read all the information they have available as well as follow their recommendations for home canning procedures.

- Use only a completely flat bottom canner with no ridges that radiate from the bottom center when home canning. Heat is spread more evenly when the bottom surface is flat. Use a straight-edge to check canner bottom.
 - Make sure the diameter of the canner does not exceed 1 inch (25mm) beyond the surface element markings or burner.
 - It is recommended to use smaller diameter canners on electric coil and ceramic glass cooktops and to center canners on the burner grates.
 - Start with hot tap water to bring water to boil more quickly.
 - Use the highest heat setting when first bringing the water to a boil. Once boiling is achieved, reduce heat to lowest possible setting to maintain that boil.
 - Use tested recipes and follow instructions carefully. Check with your local Cooperative Agricultural Extension Service or a manufacturer of glass jars for the latest canning information.
 - It is best to can small amounts and light loads.
 - Do not leave water bath or pressure canners on high heat for an extended amount of time.
-

20 BEFORE SETTING OVEN CONTROLS

Oven Vent Location

The oven vent is located under the control panel and at the back of the cooktop as shown below. When the oven is on, warm air is released through the vent; this venting is necessary for proper air circulation in the oven and good baking results.

Do not block oven vent. Never close off the openings with aluminum foil or any other material. Steam or moisture may appear near the oven vent; this is normal.

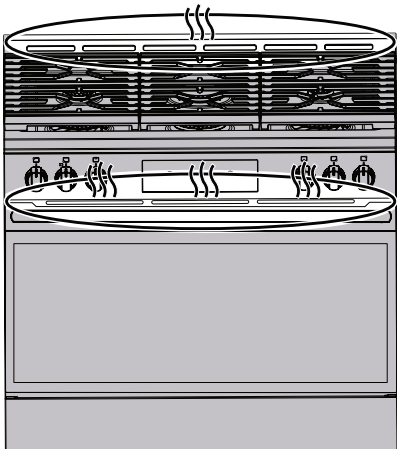

WARNING

Protective Liners — Do not use aluminum foil or any other material or liners to line the oven bottom, walls, racks or any other part of the range. Doing so will alter the heat distribution, produce poor baking results, and possibly cause permanent damage to the oven interior. Improper installation of these liners may result in risk of electric shock or fire. During self clean, temperatures in the oven will be hot enough to melt foil.

CAUTION

Always use pot holders or oven mitts when using the oven. When cooking, the oven interior, oven exterior, oven racks, and cooktop will become very hot which can cause burns.

Remove all oven racks before starting a self clean cycle. If oven racks are left inside the oven during a cleaning cycle, the slide ability of the oven racks may be damaged and all of the oven racks will lose their shiny finish.

To prevent possible damage to the oven, do not attempt to close the oven door until all the oven racks are fully positioned back inside the oven cavity.

Easy Access Side Rack

Easy Access side racks attach to each side of the oven wall. It has 5 rack positions and supports the horizontal racks.

Installing the Side Racks:

1. Insert the rear peg into the rear access hole provided, ensuring peg is fully inserted.
2. Then locate the front peg into the front access hole and push in firmly.



Figure 9: Pegs on Side Rack

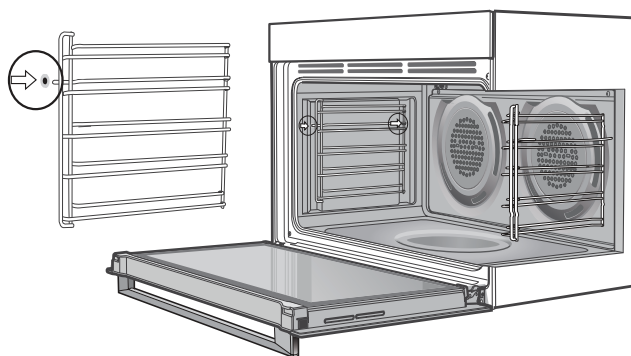

Figure 10: Easy Access Side Rack Installation

IMPORTANT

Always install the oven racks when the oven is cool.

Types of Oven Rack

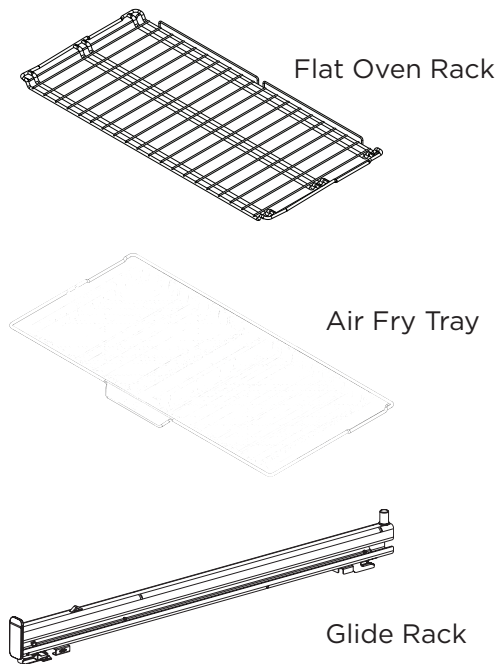

Figure 11: Oven rack types

- **Flat oven rack** may be used for most cooking needs and may be placed in most oven rack positions.
- **Air fry tray** is used for even heating on all sides without having to turn the food.
- **Glide rack** is fully extendable makes food preparation easier. This oven rack has glide tracks that allow the rack to be pulled away from the oven without rubbing the sides of the oven wall.

➔ IMPORTANT

Remove all oven racks and clean according to instructions provided in the Care & Cleaning section of this manual. Never pick up hot oven racks or parts.

Using Menu Options to Customize Your Cooking Experience

When you first install your appliance, the screen will prompt you to set your preferences. You can always change them later using the menu ≡.

1. Touch the **Menu Options** bars and scroll to find the desired option.
2. Select option and set your preference.
3. Save and go back or **Save & Close**.

You can press the **X** to close without saving changes.

Clock

When the appliance is first plugged in or when the power supply to the appliance has been interrupted, the display will show 12:00. It is recommended to always set the clock for the correct time of day before using the appliance.

1. Touch **Menu Options** bars and scroll to **Clock**. You will see options to turn off the clock display when the oven is off, to change from 12-hour to 24-hour time, and to set the clock.
2. Touch **Set Clock** and set time using graph.
3. Set **AM** or **PM**.
4. **Save & Close**.

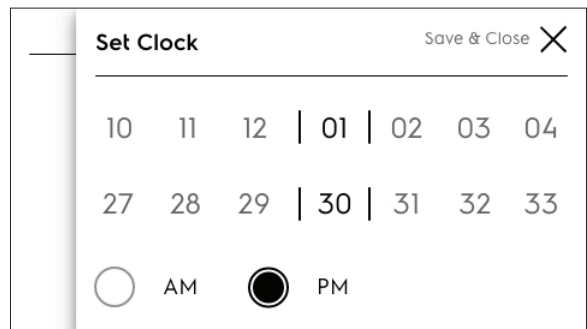

22 BEFORE SETTING OVEN CONTROLS

Energy Saving Mode

The oven control has a factory preset built-in 12-Hour Energy Saving feature that will turn off the oven if the oven is left on for more than 12 hours. The control may be programmed to override this feature to bake continuously.

1. Scroll to **Energy Saving Mode** and touch.
2. Follow the information to override the Energy Saving feature if necessary.
3. **Save & Close.**

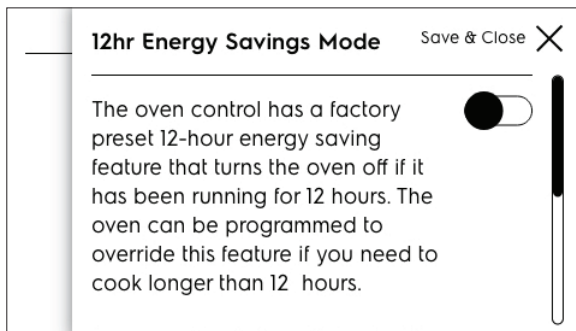

General Settings

1. Scroll to **General Settings** and touch.
2. Different options will appear.
3. Select an option to see how it is set and change if desired.

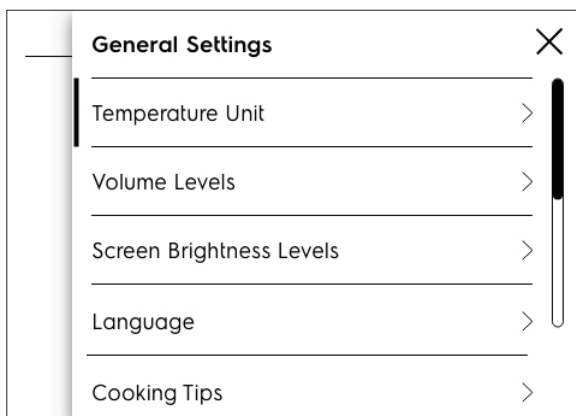

Temperature Unit

The electronic oven control is set to display °F when shipped from the factory. The display may be changed to show either °F or °C oven temperatures.

Temperature Unit > o Fahrenheit
o Celsius

1. Select **Fahrenheit** or **Celsius.**
2. **Save & Close.**

Volume

Volume allows the oven control to operate with strong tones, quiet tones, or no tones.

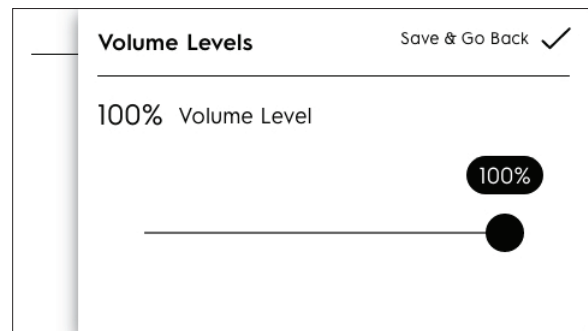

1. Use the slider to set the volume.
2. **Save & Go Back.**

Screen Brightness

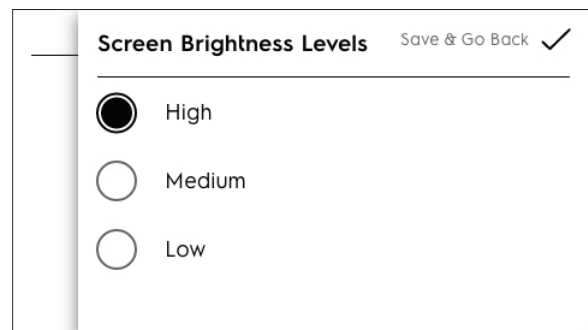

1. Choose brightness and **Save & Close.**

Language



1. Select desired language.
2. **Save & Close.**

Cooking Tips

You can switch whether cooking tips are displayed or not by choosing On or Off.

Favorites

Scroll to Favorites and touch.

- **Quick Start Options** > Oven 350°F (can change the default when Quick Start is selected).
 1. Change temperature if desired.
 2. **Save.**
- **Temperature Options** > Adjust Custom Preheat default.
 1. 325°F / 163°C
 2. 375°F / 191°C
 3. 400°F / 204°C

Oven Temperature Calibration

Your appliance has been factory calibrated and tested to ensure an accurate baking temperature. For the first few uses, follow your recipe times and temperature recommendations carefully. If you think the oven is cooking too hot or too cool for your recipe times, you can adjust the control so the oven cooks hotter or cooler than the temperature displayed.

Important: Do not use oven thermometers such as those found in grocery stores to check the temperature settings inside your oven. These oven thermometers may vary as much as 20° to 40° from actual temperatures.

1. Scroll to **Oven Temperature Calibration** and touch.
2. Option to adjust is shown.
3. Use slider to increase or decrease default oven temperature.
4. Save and go back or Save & Close.

The oven temperature may be increased as much as +35°F (+19°C) or decreased -35°F (-19°C) from the factory calibrated settings.

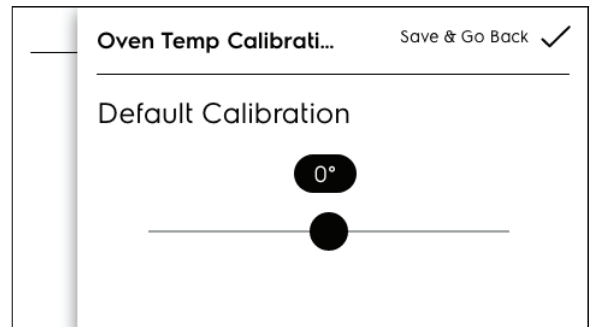

24 BEFORE SETTING OVEN CONTROLS

Sabbath Mode

1. Scroll to **Sabbath Mode**.
2. Read and follow all instructions to set and when finished cancel. See “Setting the Sabbath Feature for the Jewish Sabbath and Holidays” on page 46 for complete details on how Sabbath mode works with your oven controls.

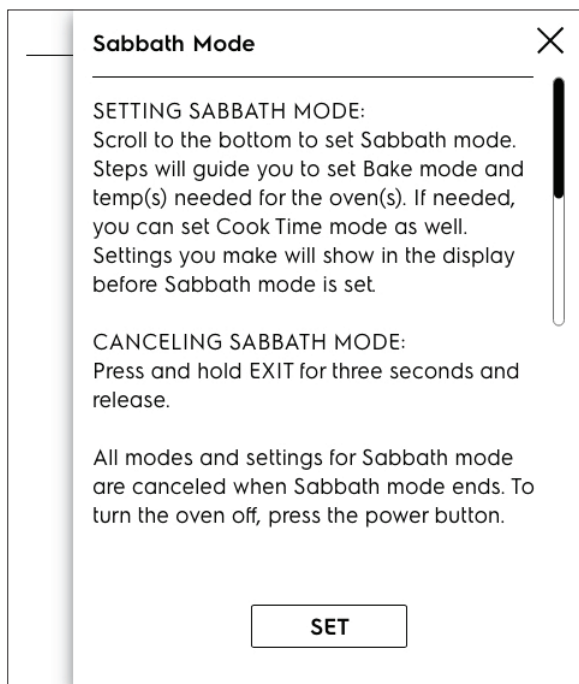

Factory Reset

1. Scroll to **Factory Reset** and touch.
2. Follow screen prompts.

Note: Your appliance was set with predetermined (default) oven control settings. Over time, users may have made changes to these settings. The following options may have been modified since the appliance was new:

- 12 or 24 hr display mode
- Screen Brightness
- Language
- Favorites
- Show Clock
- Continuous bake or 12 hour Energy Savings Mode
- Silent or audible control
- Oven temperature display (Fahrenheit or Celsius)
- Oven temperature adjustments (UPO)

If Reset is touched all the settings will return to default.

3. **Are you sure?**
4. **Reset.**
5. **OKAY.**

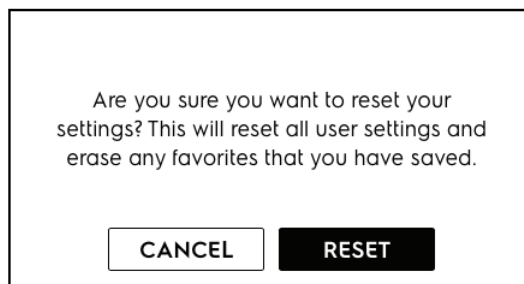

Lock Screen

As a safety measure, the oven doors and controls can be locked. Follow screen directions to lock and unlock.

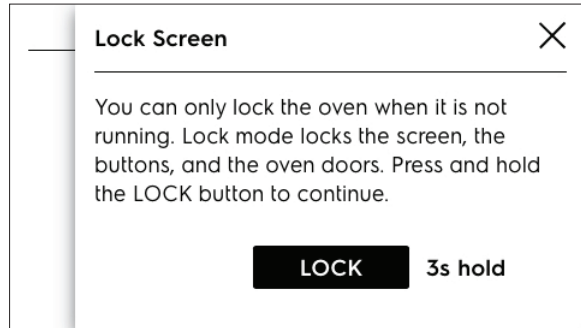

From the Settings Menu, Select **Lock Screen**, then touch and hold **LOCK** for 3 seconds.

When the doors and controls are locked the screen will show the time of day, a note that the oven is locked, and an **UNLOCK** key.

To unlock the oven door and control, press **UNLOCK** and follow directions on the screen. You will be shown a code to use for unlocking the doors and controls.

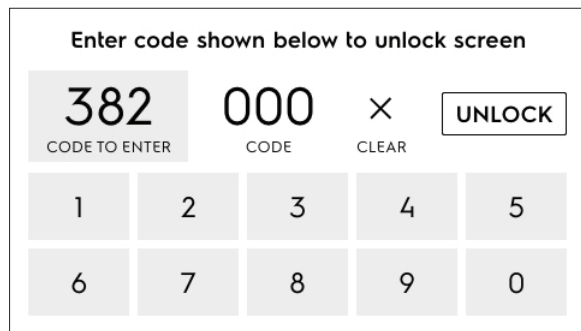

About the Appliance

1. Scroll to **About the Appliance** and touch.
2. Touch headings to see information.

Important information about the appliance such as the the software version number and contact information for support is listed here.

26 SETTING OVEN CONTROLS

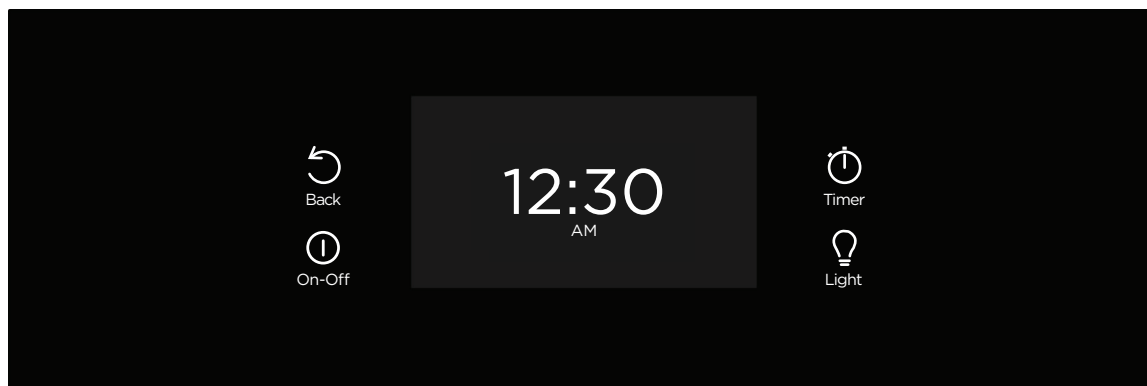

ON / OFF

When **ON/OFF** is pressed, the display opens to the Quick Start screen.

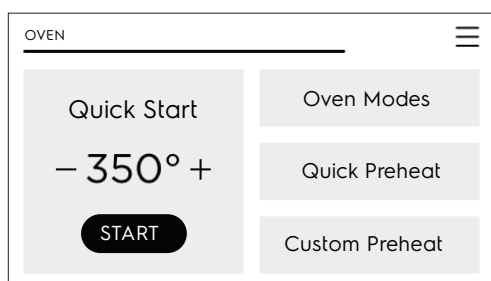

NOTE

In addition to **ON/OFF**, touching the screen will also activate the display.

If the oven is on when **ON/OFF** is pressed, it will turn off completely, canceling any functions that are running at the time.

BACK

Pressing the **Back** key will return to the previous screen without implementing any changes you may have selected.

TIMER

Pressing **Timer** will access the timer function. The timer will count down the amount of time you specify, and a tone will sound when the timer reaches zero. You can set a timer from 1 minute to 11 hours and 59 minutes.

Enter the desired time and press **START**. While the timer is running, you can pause or cancel the countdown. You can also add or subtract time by pressing (+) or (-).

LIGHT

Press the Light key to turn the oven light on or off.

Quick Start

When **ON/OFF** is pressed the display opens to the Quick Start screen.

From the Quick Start screen, you can immediately start the Bake function by pressing **START**. You can adjust the temperature by pressing (+) or (-).

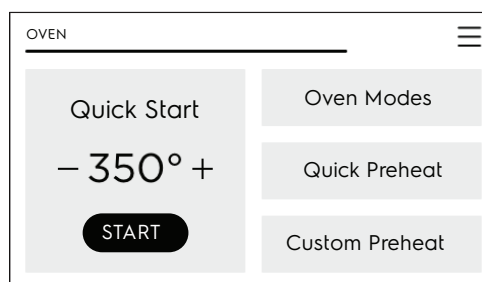

To select other cooking options, touch **Oven Modes** and scroll to the desired feature.

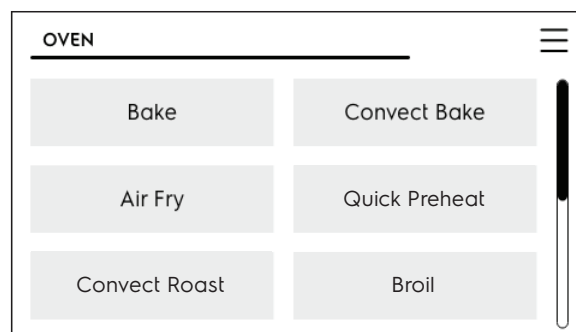

Use the scroll bar to find your oven mode as shown in the oven mode screen. When you select a cooking mode simply follow the tips for setting the particular mode.

Important: Valuable tips to help you get the best results are included in the display and also can be found in this User Manual.

Table 2: Minimum and maximum control settings

Feature	Mode	Min Temp/ Time	Max Temp/ Time
Bake		170°F (77°C)	550°F (288°C)
Broil		400°F (205°C)	550°F (288°C)
Air Fry		170°F (77°C)	550°F (288°C)
Steam Bake		170°F (77°C)	550°F (288°C)
Steam Roast		170°F (77°C)	550°F (288°C)
Conv Bake		170°F (77°C)	550°F (288°C)
Conv Roast		170°F (77°C)	550°F (288°C)
Food Probe		140°F (60°C)	210°F (99°C)
Multi Rack		170°F (77°C)	550°F(288°C)
Quick Preheat		170°F (77°C)	550°F (288°C)
Keep Warm		140°F (60°C)	200°F (93°C)
Bread Proof		100°F (38°C)	11:59 Hr./Min.
Dehydrate		95°F (35°C)	170°F (77°C)
Slow Cooker	Low Med High	200°F (93°C)	250°F (121°C)
Timer		0:01 Min.	11:59 Hr./Min.
Clock Time	12 Hr. 24 Hr.	1:00 Hr./Min. 0:00 Min.	11:59 Hr./Min. 23:59 Hr./Min.
Delay Start		0:01 Min.	1:00 Hr./Min.
Cook Time	12 Hr. 24 Hr.	0:01 Min. 0:01 Min.	11:59 Hr./Min. 11:59 Hr./Min.
Self Clean		2 hours	4 hours
Steam Clean		NA	NA

Modes

- Bake (page 28)
- Quick Preheat (page 29)
- Convection Bake (page 30)
- Air Fry (page 31)
- Slow Cook
 - Dehydrate (page 32)
 - Bread Proof (page 32)
 - Slow Cooker (page 33)
- Convection Roast (page 33)
- Broil (page 35)
- Multi Rack (page 37)
- Steam Bake (page 38)
- Steam Roast (page 38)
- Keep Warm (page 39)
- Delay Start (page 39)
- Self Clean (page 40)
- Steam Clean (page 43)
- Food Probe (page 44)

28 SETTING OVEN CONTROLS

Bake

Bake uses heat that rises from the oven bottom and a convection element for best baking results.

A reminder tone will sound indicating when the set bake temperature is reached and to place the food in the oven.

Bake may be set for any oven temperature between 170°F (77°C) to 550°F (288°C).

CAUTION

Always use pot holders or oven mitts when using the oven. When cooking the oven interior, oven racks, and cooktop will become very hot which can cause burns.

Baking tips

- Fully preheat the oven before baking items like cookies, cakes, biscuits and breads.
- For all baking except layer cakes, pans should be centered in oven cavity.
- Use the convection bake function for best results when baking cookies or cakes on multiple racks.
- For best results when baking layer cakes using two oven racks, place racks in positions 3 and 5. Place top rack cakes in the back and bottom rack cakes in the front as shown in figure.

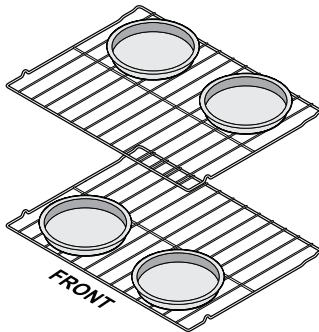

- When using any single rack for baking cookies, cakes, biscuits, or muffins use rack position 3.
- All two rack banking in radiant bake should use rack 3 and 5.
- Allow at least 2 inches (5 cm) of space between bakeware for proper air circulation.
- Leave oven lights off while baking.

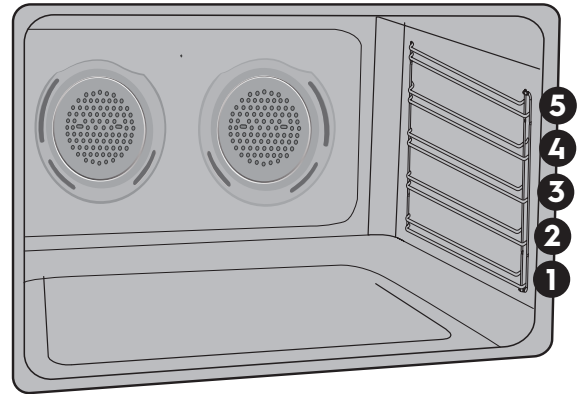
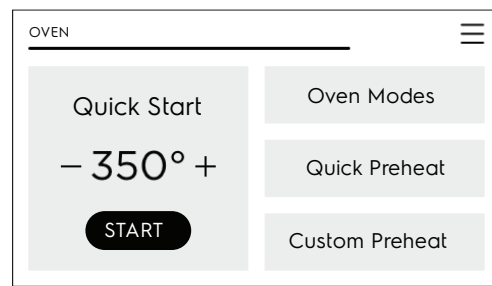

Figure 12: Rack Positions

To set Bake:

1. Press **ON/OFF** key.



2. Touch **Oven Modes** and touch **Bake**. The default temperature 350°F (177°C) will show in the display. You can also use the controls on the Quick Start screen.
3. To set the temperature to 375°F (190°C), use the numbered keys to program the new temperature of 375°F (190°C) and touch **START**.
4. The screen shows the current temperature and a **Cook Time** button.
5. Touch **Cook Time** to set a cooking time if needed.

NOTE: If a cook time is set the oven will turn off automatically when the time expires.

6. Touch **START**.
 7. When cooking has ended, **Off** will be in display. Press **ON/OFF** to turn off the oven and show time of day in the display.
- To cancel cooking at anytime, touch **CANCEL**.

Setting Cook Time

Use Cook Time to set the amount of time needed for most oven functions. The oven will turn on immediately (or after a specified delay) and stop automatically after the set cook time ends.

In most cases you will see a cooking tip suggesting to set Cook Time after the oven is preheated.

When the programmed cook time ends:

- **Off** will appear in the display window.
- An alert tone will sound.
- The oven will turn off automatically.

The **Off** message and an **OKAY** button will display until **OKAY** is touched.

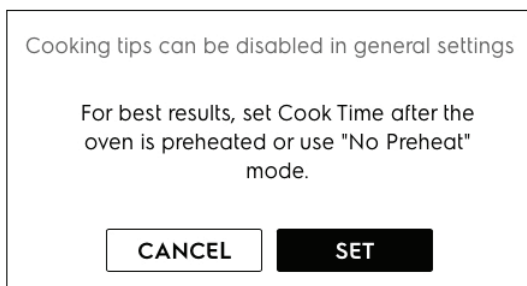

NOTE: The maximum cook time setting is 11 hours and 59 minutes unless the oven is set for continuous cooking.

To change the oven temperature or cook time after baking has started:

- Touch **(+)** or **(-)** on either side of the set temperature.
- Touch **TEMP** to access the keypad.

Quick Preheat

Quick Preheat is available with single rack baking with packaged and convenience foods. Quick Preheat may be used with temperatures between 170°F (77°C) and 550°F (288°C). Follow the recipe or package direction for food preparation time and temperature.

During Quick Preheat function, the oven elements will cycle on and off. The convection fan will turn on and stay on until Quick Preheat is cancelled. Depending on your preference for doneness cooking times may vary. Watch food closely.

Important:

- Always place food in center of the oven rack position 3.
- For best results when baking batter and dough-based items such as cookies and pastries, use convection bake function and place food in oven when the reminder tone sounds signaling the oven is fully preheated.
- Food may need to be removed early and should be checked at minimum recommended bake time.

To Set Preheat:

1. Press **ON/OFF** key.

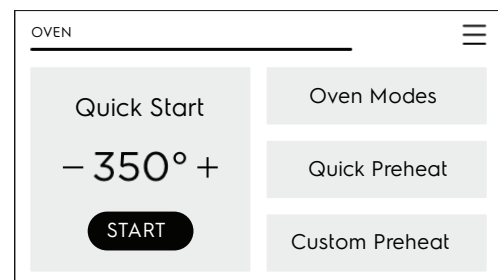

2. Touch **Quick Preheat** from **Quick Start** display or alternatively, touch **Oven Modes** and touch **Quick Preheat**.
3. Default temperature of 350°F (177°C) will be displayed on screen. Select desired temperature between 170°F (77°C) to 550°F (288°C).
4. Touch **START**.
5. Set **Cook Time** if needed.
6. Touch **START**.
7. Alert tone will sound once the oven has reached set temperature.
8. When cooking has ended, **Off** will be in display.
9. Touch **OKAY** to return to Quick Start screen. To cancel cooking at anytime, touch **CANCEL**.

30 SETTING OVEN CONTROLS

Convection Bake

Convection Bake uses a fan to circulate the oven's heat around the oven; this improved heat distribution allows for even cooking and browning results. Heated air flows around the food from all sides.

Convection bake may be set for any oven temperature between 170°F (77°C) and 550°F (288°C).

Benefits of convection cooking include:

- Multiple rack baking.

Convection baking tips:

- Use Convection Bake for best results when baking cookies and cakes on 2 racks.
- For best results it is recommended to preheat the oven before baking items like cookies, biscuits and breads and keep pans centered to the oven cavity.
- If your recipe is not written for convection baking, reduce the oven temperature by 25° or use Convection Convert option.
- No special pans or bakeware required.

For cookies use the following racks:

- Single rack baking use 3 (flat rack).
- Two rack baking use rack 3 and 5.
- For baking cakes use the following rack positions and place bakeware as shown in Figure 13. In upper rack use position 5.
- Cookies and biscuits should be baked on pans with no sides or very low side to allow heated air to circulate around the food. Food items baked on pans with a dark finish will cook faster.
- Leave oven lights off while baking.

Convection Convert

Convection Convert automatically reduces the oven temperature from what is specified in most baking recipes to compensate for the increased cooking efficiency of convection baking.

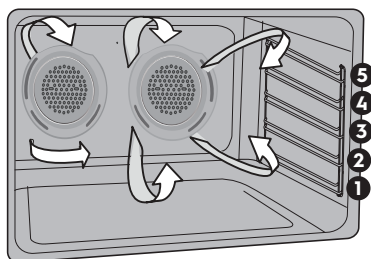

To set convection bake with a default oven set temperature of 325°F (163°C):

1. Select **Oven Mode** and scroll to **Convection Bake**.
2. Touch **Convection Bake**: Default oven temp of 325°F (163°F) appears.
3. An option for **Convection Convert** is visible on the screen. Using it will lower the oven temperature 25° to account for the increased efficiency of convection. If used, Convection Convert must be selected before pressing start.
4. Touch **START**.
5. Touch **Cook Time** to set a cooking time if needed.
6. Touch **START**.
7. Oven will turn off when **Cook Time** is complete.
8. Cooking has ended and **Off** will be in display.
9. Press **ON/OFF** to return display to show the time of day.

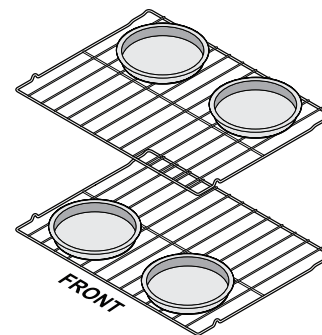
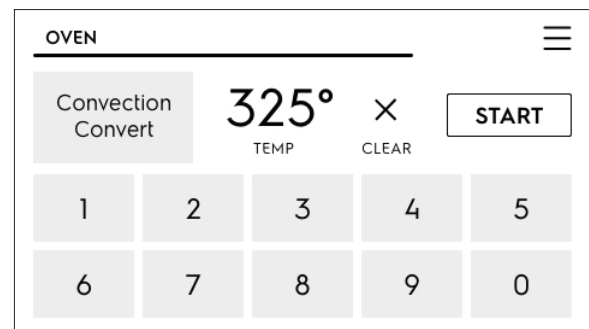

Figure 13: Pan positions for best results when baking cakes on two racks.

Air Fry

The Air Fry feature works best for single rack baking with packaged and convenience foods. It works well with most recipes and can be programmed for temperatures between 170°F (77°C) and 550°F (288°C). Follow the recipe or package directions for food preparation, quantity, time, and temperature.

Important:

- Air Fry is designed for cooking on a single oven rack. Food should be arranged in single layers on a tray.
- When using Air Fry, place food on rack position 4 for best results. Place drip tray on rack position 2 to catch any crumbs or drippings. See figure 14 for Air Fry tray and Drip tray.
- Food may need to be removed early and should be checked at minimum recommended bake time. However, frozen dense foods and items with cook times less than 15 minutes may require additional time.

To set the Air Fry function:

1. Arrange food on rack as suggested.
2. Select **Air Fry** from Oven Modes.
3. Enter the suggested temperature for particular food. Touch **START**.
4. When preheat tone sounds, place the tray on rack position 4 and to prevent smoke, place a drip tray under on rack position 2 below the air fry tray.
5. If setting a Cook Time, set after the oven is preheated. Cook time turns off Air Fry when time is finished.

NOTE: Setting the timer for the minimum suggested time after preheat is a good option and checking food for doneness.

6. When cook time ends **Off** will be in display.
7. Press **ON/OFF** to return display to show the time of day.

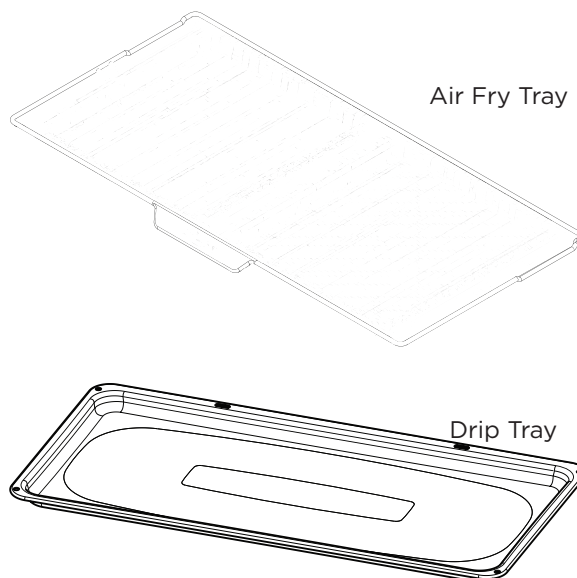

Figure 14: Air Fry Tray and Drip Tray

Table 3: Air Fry Table

Food Type	Quantity (oz.)	Temperature	Cook Time (mins)
Frozen Tater Tots	64 (32 oz per basket)	450°F (232°C)	29-33
Frozen Golden Fries	64 (32 oz per basket)	425°F (218°C)	25-35
Frozen Chicken Nuggets	64 (32 oz per basket)	400°F (205°C)	13-15
Frozen Crispy Chicken Strips	64 (32 oz per basket)	400°F (205°C)	20-22
Frozen Hot Wings Bone-In	64 (32 oz per basket)	450°F (232°C)	25-28
Frozen Chicken Wings	64 (32 oz per basket)	375°F (190°C)	60-65
Fresh Chicken Wings	64 (32 oz per basket)	450°F (232°C)	30-40

32 SETTING OVEN CONTROLS

Dehydrate

For best results when dehydrating food use the Air Fry tray which allows air to circulate all around the food for faster preservation.

Tips

- Always use clean equipment and utensils.
- Keep meat and poultry refrigerated -- 40°F (4°C) or slightly below -- before dehydrating.
- Cut food in evenly sized pieces. Slices should be even and ¼ to ½ inch thick; this will ensure all pieces are dehydrated at same rate.
- Use good quality fruits, vegetables, and meats. Overripe or bruised fruits and vegetables may turn black while dehydrating.
- Use lean cuts of meat or trim off excess fat.
- Use a paper towel to dry meat before dehydrating.
- Store dehydrated foods in airtight containers. If moisture appears in containers, the food was not dehydrated properly.
- Follow USDA recommendation when dehydrating.

To set Dehydrate:

1. Arrange food in a single layer on the Air Fry tray.
2. Touch **Oven Modes** and scroll to **Slow Cook**, then choose **Dehydrate** from the sub-menu.
3. Set dehydrate temperature (between 95°F -170°F).
4. Touch **START**.
5. Press **ON/OFF** to end cooking and return display to show the time of day.

Table 4: Dehydration Temp and Time Suggestions

Food	Temperature	Hours	Food	Temperature	Hours	
Herbs, flowers	95°F (35°C)	6-10	Citrus Peel	135°F (57°C)	8-15	
Vegetables	125°F (52°C)	8-20	Fruit	145°F (63°C)	5-7	
Tomatoes			Apples			8-20
Peppers			Bananas			8-20
Mushrooms			Strawberries			12-18
Meat	165°F (74°C)	6-18	Fish	145°F (63°C)	8-12	
Root Vegetables	165°F (74°C)	6-10 10-15	Fruit Rolls/Leather	165°F (74°C)	8-18	
Carrots			Nuts and Seeds	150°F (66°C)	8-20	
Potatoes						

NOTE

Check food for doneness. If any moisture is present, allow food to dehydrate longer.

Bread Proof

Bread proofing creates the best conditions for yeast to multiply and cause your dough to rise.

1. Touch **Oven Modes** and scroll to **Slow Cook**, then choose **Bread Proof** from the sub-menu.
2. Touch **Bread Proof**: Shows **Bread Proof 100°F (38°C)**.
3. Touch **START**.

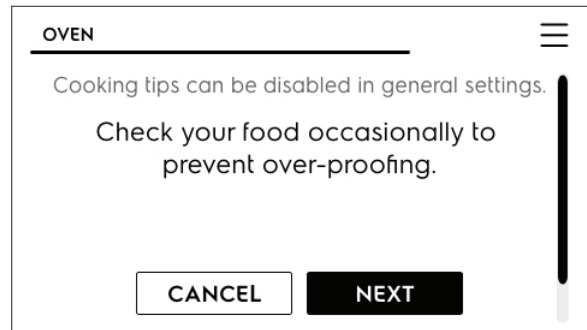

NOTE

Check often to prevent over-proofing.

Slow Cooker

Use Slow Cooker for foods that will cook or braise at low temperature for a long period of time.

For best results when using Slow Cooker:

- Completely thaw all frozen foods before cooking.
- When using a single oven rack, place in oven rack position 2 or 3. Position racks to accommodate the size of various bakeware when cooking multiple food items.
- Do not open the oven door often or leave the door open when checking foods. If the oven heat escapes often, the Slow Cooker time may need to be extended.
- Cover to keep foods moist or use a loose or vented type cover to allow foods to turn crisp or brown.
- Roasts may be left uncovered so browning can occur. Cook times will vary depending on the weight, fat content, bone, and the shape of the roast. Preheating the oven will not be necessary when using the Slow Cooker feature.
- Add any cream or cheese sauces during the last hour.

Slow cooking meats may result in the outside of the meat turning dark; this is normal.

To set Slow Cooker:

1. Touch **Oven Modes** and scroll to **Slow Cook**, then choose **Slow Cooker** from the sub-menu.
2. The display shows **LOW** (200°F), **MEDIUM** (225°F) or **HIGH** (250°F). Select desired temperature and touch **START**.
3. The screen shows the current temperature and a **Cook Time** button.
4. Touch **Cook Time** to set a cooking time if needed.

NOTE: If a cook time is set, the oven will turn off automatically when the time expires.

5. Touch **START**.
6. When cooking has ended, **Off** will be in display. Press **OK** to return to the start screen.

Press **ON/OFF** to turn off the oven and show time of day in the display.

To cancel cooking at any time, touch **CANCEL**.

Convection Roast

Convection roast combines a cook cycle with the convection fan and elements to rapidly roast meats and poultry. Heated air circulates around the meat from all sides, sealing in juices and flavors. Meats cooked with this feature are crispy and brown on the outside while staying moist inside.

! WARNING

Should an oven fire occur, close the oven door and turn the oven off. If the fire continues, use a fire extinguisher. Do not put water or flour on the fire. Flour may be explosive and water can cause a grease fire to spread and cause personal injury.

! CAUTION

Always use pot holders or oven mitts when using the oven. When cooking, the oven interior, oven racks, and cooktop will become very hot which can cause burns.

To use convection roast at a temperature of 350°F (177°C):

1. Touch **Oven Mode** and scroll to **Convection Roast**.
2. Touch **Convection Roast**.
3. Set desired temperature or use default of **350°F**.
4. Touch **START**.
5. Touch **Cook Time** to set a cooking time if needed.
6. Touch **START**. Preheating the oven is not necessary.
7. When cooking is completed or to cancel Convection Roast press **ON/OFF**.

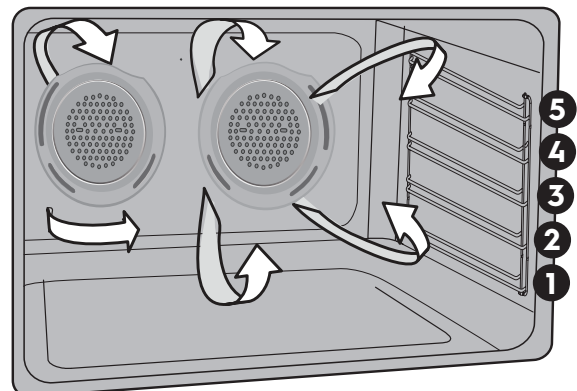

Figure 15: Convection roasting on lower oven racks

34 SETTING OVEN CONTROLS

Convection Roasting tips:

- Preheating for convection roast is not necessary for most meats and poultry.
- Arrange oven racks so meat and poultry are on the lowest rack of the oven.
- Since convection roast cooks faster, you may be able to reduce cook times as much as 25% from the recommended time of your recipe (check the food at this time). Then if needed, increase cook time until the desired doneness is obtained.
- Do not cover foods when dry roasting - covering will prevent the meat from browning properly.
- When cooking meats use the broiler pan and insert. The broiler pan will catch grease spills and the insert helps prevent grease splatters.

Table 5: Convection Roasting recommendations

Meat		Weight	Oven Temp	Internal Temp	Mins per lb
Beef	Standing rib roast*	4 to 6 lb.	350°F (177°C)	*160°F (71°C)	25-30
	Rib eye roast*	4 to 6 lb.	350°F (177°C)	*160°F (71°C)	25-30
	Tenderloin roast	2 to 3 lb.	400°F (204°C)	*160°F (71°C)	15-25
Poultry	Turkey whole**	12 to 16 lb.	325°F (163°C)	180°F (82°C)	8-10
	Turkey whole**	16 to 20 lb	325°F (163°C)	180°F (82°C)	10-15
	Turkey whole**	20 to 24 lb.	325°F (163°C)	180°F (82°C)	12-16
	Chicken	3 to 4 lb.	350°F-375°F (177°C- 191°C)*	180°F (82°C)	12-16
Pork	Ham roast, fresh	4 to 6 lb.	325°F (163°C)	*160°F (71°C)	30-40
	Shoulder blade roast	4 to 6 lb.	325°F (163°C)	*160°F (71°C)	20-30
	Loin	3 to 4 lb.	325°F (163°C)	*160°F (71°C)	20-25
	Pre-cooked ham	5 to 7 lb.	325°F (163°C)	*160°F (71°C)	30-40

* The U.S. Department of Agriculture states, "Rare fresh beef is popular, but you should know that cooking it to only 140°F (60°C) means some food poisoning organisms may survive." (Source: Safe Food Book, Your Kitchen Guide) The lowest temperature recommended by the USDA is 145°F (63°C) for medium rare fresh beef.

For well done 170°F (77°C)** Stuffed turkey requires additional roasting time. Shield legs and breast with foil to prevent over browning and drying of the skin.

Broil

Use the broil function to cook foods that require direct exposure to radiant heat for optimum browning results. Broiling may produce smoke. If smoke is excessive, place food further away from the heating element.

The broil feature preset to 550°F. Broil may be set at any temperature between 400°F (205°C) and 550°F (288°C).



WARNING

Should an oven fire occur, close the oven door and turn the oven off. If the fire continues, use a fire extinguisher. Do not put water or flour on the fire. Flour may be explosive and water can cause a grease fire to spread and cause personal injury.



CAUTION

Always use pot holders or oven mitts when using the oven. When cooking, the oven interior, oven racks, and cooktop will become very hot which can cause burns.

To set broil with the default broil oven temperature of 550°F (288°C):

1. Arrange the oven racks when cool. For optimum browning results, preheat oven for 5 minutes before adding food.
2. Select **Oven Mode** and scroll to **Broil**.
3. Default **550°** appears.
4. If lower broil temperature is needed use keypad to select between 400° and 550°.



5. Press **START**. Broil with oven door closed.
6. Broil on one side until food is browned; turn and broil other side until done to your satisfaction.
7. When finished broiling, press **ON/OFF**.

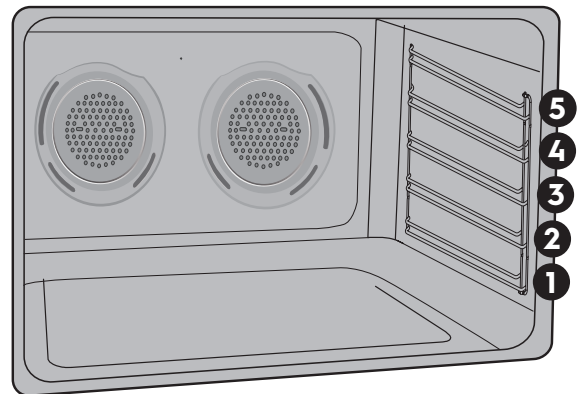

36 SETTING OVEN CONTROLS

Important notes:

- Always arrange oven racks when the oven is cool.
- For best results when broiling, use a broil pan with broil pan insert designed to drain the fat from the food and help avoid splatter and reduce smoking.
- When broiling, always pull the oven rack out to the stop position before turning or removing food.

Table 6: Broil recommendations

Food item	Rack Position	Temperature	Cook time in minutes		Internal Temperature	Doneness
			1st side	2nd side		
Steak 1" thick	5	550°F (288°C)	5:00	5:00	140°F (60°C)	Rare**
Steak 1" thick	5	550°F (288°C)	6:00	4:00	145°F (63°C)	Medium
Steak 1" thick	5	550°F (288°C)	7:00	5:00	160°F (71°C)	Medium-well
Steak 1" thick	5	550°F (288°C)	8:00	6:00	170°F (77°C)	Well
Pork Chops 3/4" thick	5	550°F (288°C)	12:00	10:00	170°F (77°C)	Well
Chicken - Bone In	5	450°F (232°C)	20:00	10:00	170°F (77°C)	Well
Chicken Boneless	5	450°F (232°C)	8:00	6:00	170°F (77°C)	Well
Fish	5	550°F (288°C)	as directed		170°F (77°C)	Well
Shrimp	5	550°F (288°C)	as directed		170°F (77°C)	Well
Hamburger 1" thick	5	550°F (288°C)	9:00	7:00	145°F (63°C)	Medium
Hamburger 1" thick	5	550°F (288°C)	10:00	8:00	170°F (77°C)	Well

The U.S. Department of Agriculture states, "**Rare fresh beef is popular, but you should know that cooking it to only 140°F (60°C) means some food poisoning organisms may survive." (Source: Safe Food Book, Your Kitchen Guide, USDA Rev. June 1985.) The lowest temperature recommended by the USDA is 145°F (63°C) for medium rare fresh beef. For well done 170°F (77°C). All cook times shown are after 2 minutes of preheating.

Multi Racks

Multi Racks is for baking on up to two racks while following recommended time and temperature. The oven will make adjustments for best results.

IMPORTANT: Be sure to use suggested rack positions before setting oven.

Follow recipe for time and temp and the oven will make needed adjustments for best performance.

- Fully preheat the oven for best results.
- Allow at least 2 inches (5 cm) of space between bakeware for proper air circulation.
- Leave oven lights off while baking.
- Use flat rack in position 3 and 5.

To use Multi Racks:

1. Arrange the oven racks when cool.
2. Select **Oven Mode** and scroll to **Multi Racks**.
3. Touch **Multi Racks**.
4. Default **350°** appears. Set another temperature if desired.
5. Touch **START**.
6. Set **Cook Time** if needed.
7. Press **START**.
8. When Cook Time ends the oven turns off automatically.
9. Cooking has ended and Off will be in display.
10. Press **ON/OFF** to return display to show the time of day.

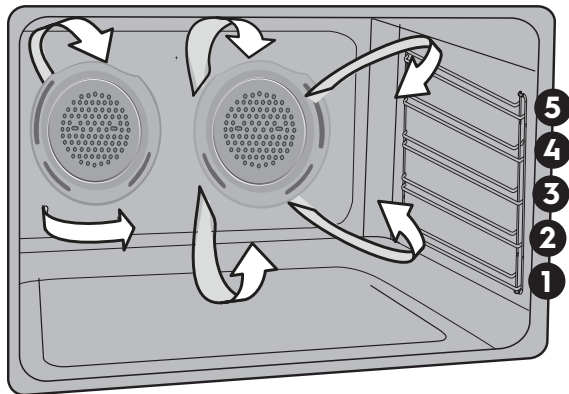

Cooking with Steam

NOTE: More moisture will be present than during conventional baking or roasting. Moisture could condense on the handle or in the door, and depending on the conditions in your kitchen possibly drip onto the floor.

Steam Cooking Tips:

Rack Positioning

- Use flat rack in the center position 3 in the oven for most foods for Steam Roast and Steam Bake.
- Lowest oven rack position for poultry.

Preparing

- Use 2 ½ cups of water for steam bake and steam roast. If steam functions are frequently used, use distilled water.
- Pour water slowly onto the bottom of oven cavity while still cool.
- Never add water if the oven is warm.
- Never add water during a Steam Bake or Steam Roast cycle.

While in Use

- When using Steam, follow the recipe for pre-heating, cook time, and cook temperature.
- Always start with a cold oven.
- Preheating is not necessary when using steam roast.

Cleaning

- With a paper towel lightly soaked in distilled white vinegar, wipe out bottom of oven cavity after the oven is cooled or before each use.
- Use the self clean function to clean heavily soiled areas.
- If residue remains after self clean, pour a thin layer of distilled white vinegar onto the bottom of the oven cavity. Allow to sit for 30 minutes. Wipe out vinegar.

38 SETTING OVEN CONTROLS

Steam Bake

Steam creates the best conditions for baking bread on a single rack. Baked goods will have improved browning and texture and is recommended for baking moist and flavorful breads and pastries such as baguettes and croissants.

Use flat rack in position 3 for best results for Steam Bake. Pans should be centered in the oven cavity.

To set Steam Bake:

1. Select **Oven Modes** and scroll to **Steam Bake**.
2. Add 2 ½ cups of water to oven bottom as directed.
3. Touch **NEXT** and follow Steam Bake instruction for setting temperature.
4. Touch **START**.
5. Set **Cook Time**. (Suggests waiting to set Cook Time until oven preheats.)
6. When **Cook Time** ends oven turns off automatically.
7. **Cooking has ended** and **Off** will be in display.
8. Press **ON/OFF** to return to show the time of day.

CAUTION

Do not use Steam Bake for cooking at temperatures below 225°F (107°C).

IMPORTANT

Stand to the side of the oven when opening to allow any steam to escape.

NOTE

The cooling fan will run on high during steam cooking.

Steam Roast

Steam creates the best conditions for roasting proteins. Meats will be crisp outside and juicy inside.

Steam Roast is recommended for meat or poultry. Use flat rack in position 1 for best results for Steam Roast.

To set Steam Roast:

1. Select **Oven Modes** and scroll to **Steam Roast**.
2. Add 2 ½ cups of water to the bottom of the oven as directed.
3. Touch **NEXT** and follow Steam Roast instruction for setting temperature.
4. Touch **START**.
5. When **Cook Time** ends oven turns off automatically.
6. **Cooking has ended** and **Off** will be in display.
7. Press **ON/OFF** to return display to show the time of day.

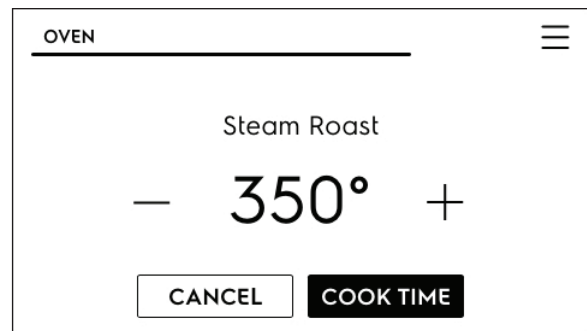

CAUTION

Do not use Steam Roast for cooking at temperatures below 325°F (163°C).

IMPORTANT

Stand to the side of the oven when opening to allow any steam to escape.

NOTE

The cooling fan will run on high during steam cooking.

Keep Warm

Keep Warm should only be used with foods that are already at serving temperatures. Keep warm will keep cooked foods warm and ready for serving after cooking has finished.

Keep warm will keep the oven temperature at 140°F - 200° F (60°C - 93°C).

To set Keep Warm:

1. If needed, arrange oven racks and place cooked food in oven.
2. Press **Oven Modes** and scroll to **Keep Warm**.
3. Touch **Keep Warm**.
4. Set desired temperature.
5. Press **START**.
6. **Keep Warm** will turn off when cancelled.



Delay Start

Delay Start allows a delayed starting time only for Bake, Convection Bake, Convection Roast, Steam Roast, Steam Clean, and Self Clean.

Prior to setting a delay start, be sure the time of day is set correctly. The maximum delay for a Delay Start is one hour (12 hours for Self Clean and Steam Clean).

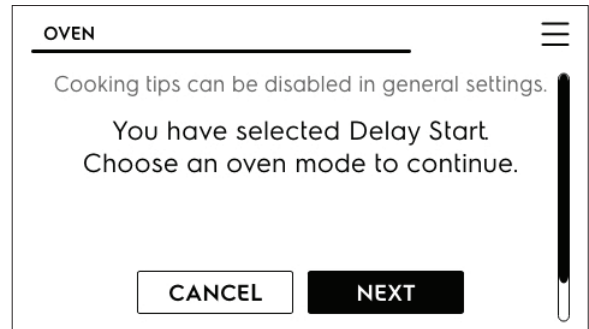

To set Delay Start:

1. Press **ON/OFF** key and touch **Oven Modes**.
2. Scroll to **Delay Start** and touch.
3. Follow the information on the screen to set delay time, temperature, and cook time.

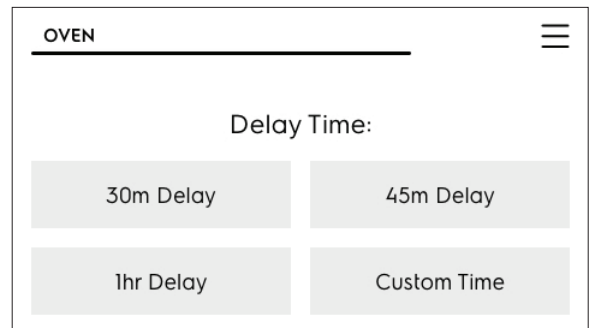

When the Delay Start time is reached, the oven will turn on and begin cooking. The screen will show the oven temperature.

When Cook Time (if used) ends, **Cooking is over** and **Off** and **OKAY** will appear in the display window, and the oven will shut off automatically.

The oven control will sound tones as a reminder until the OKAY is pressed.

WARNING

Food Poisoning Hazard. Do not let food sit for more than one hour before or after cooking. Doing so can result in food poisoning or sickness.

40 SETTING OVEN CONTROLS

Self Clean

A self cleaning oven cleans itself with high temperatures (well above normal cooking temperatures), which vaporizes soils or reduces them to a fine powdered ash you can wipe away afterwards with a damp cloth. This function can be programmed for clean times between 2 and 4 hours.

IMPORTANT: Before starting self clean read all following caution and important statements before starting a self clean cycle.

CAUTION

- Do not leave small children unattended near appliance. During self clean cycle, the outside of the oven can become very hot and cause burns if touched.
- Do not line the oven walls, racks, oven bottom, or any part of the range with aluminum foil. This will cause permanent damage to the oven interior and destroy heat distribution, and will melt to the oven interior.
- Do not force the oven door open. This will damage the automatic door locking system. Use caution when opening the oven door after the self clean cycle ends. The oven may still be very hot and cause burns. To avoid possible burns, stand to side of oven when opening door to allow steam or hot air to escape.
- The health of some birds is extremely sensitive to fumes given off during the self clean cycle of any range. Move birds to a well ventilated room.

Important notes:

- Completely remove all oven racks and any accessories from oven cavity to avoid damage to oven racks. If the oven racks are not removed they may discolor.
- Remove all items from the oven and cooktop including cookware, utensils, and any aluminum foil. Aluminum foil will not withstand high temperatures from a self clean cycle and will melt.

- Do not spray oven cleaners or oven protective coatings in or around any part of the oven interior. Clean any soil from the oven frame, the door liner outside the oven door gasket, and the small area at the front center of the oven bottom. These areas heat sufficiently to burn soil on. Clean using soap and water prior to starting Self Clean.
- Remove any excessive spills. Any spills on the oven bottom should be wiped up and removed before starting a self clean cycle. To clean use hot, soapy water and a cloth. Large spills can cause heavy smoke or fire when subjected to high temperatures.
- Do not allow food spills with high sugar or acid content (such as milk, tomatoes, sauerkraut, fruit juices, or pie fillings) to remain on the surface as they may leave a dull spot even after cleaning.
- Do not clean the oven door gasket. The woven material in the gasket is essential for a good seal. Care should be taken not to rub, damage, or remove the oven door gasket. Doing so could cause damage to the door gasket and compromise the performance of the oven.

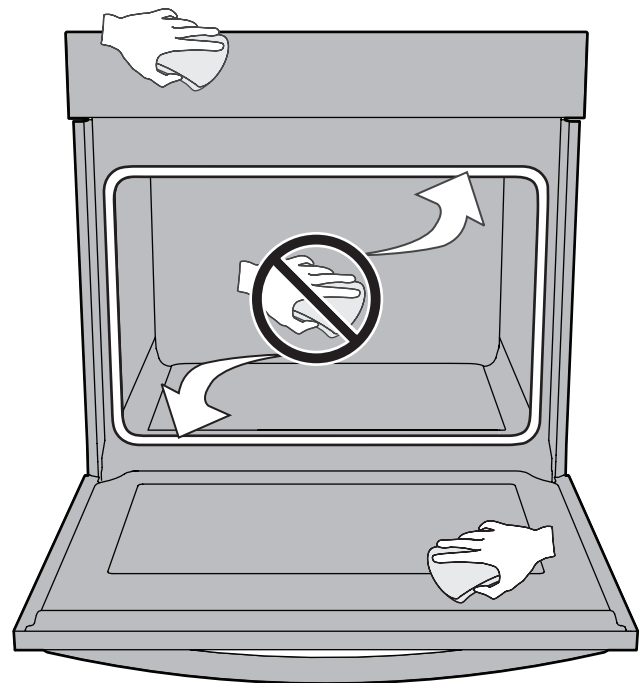
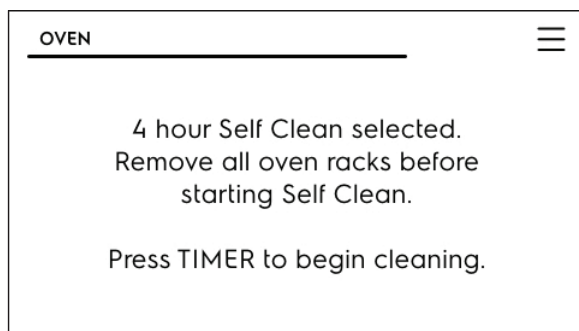

Figure 16: Clean around the oven door gasket

- The kitchen area should be well ventilated using an open window, ventilation fan, or exhaust hood during the first self clean cycle. This will help eliminate the normal odors.
- Do not attempt to open the oven door when the OVEN LOCK indicator light is flashing. Allow about 15 seconds for the motorized door latch mechanism to completely lock or unlock the oven door.
- When the clean time finishes, the oven door will remain locked until the range has cooled sufficiently. In addition to the clean time that was programmed, you must allow about 1 additional hour for the oven to cool before you will be able to open the oven door.

To set a self clean cycle:

1. Be sure the oven is empty and all oven racks are removed. Remove all items from the oven. Be sure oven door is completely closed.
2. Touch **Oven Modes** and scroll to **Self Clean**.
3. Touch **Self Clean** and select 2 hour, 3 hour, or 4 hour clean time.
4. Press **TIMER** to start the self clean cycle.



When the oven is set to run a self clean cycle, the motor door lock will begin locking the oven door. Do not open the oven door while the lock motor is running or when any locking indicators or displays are showing. The oven door is completely locked in about 15 seconds. Once the oven door has locked, **CLEAN** will appear in the display indicating self clean has started.

Do not force the oven door open when self clean is active. This can damage the automatic door-locking system. Use caution when opening the door after self clean cycle is complete; the oven may still be very hot.

When the self clean cycle has completed:

- **CLEAN** message will turn off, and **Hot** will appear in display window. The oven door will remain locked while the oven cools.
- Once the oven has cooled down (about 1 hour) and **Hot** is no longer displayed, the oven door may be opened.
- When the oven interior has completely cooled, wipe away any residue or powdered ash with a damp cloth or paper towel.

42 SETTING OVEN CONTROLS

Setting Delay Start Self Clean

To start a delay self clean with default clean time of 3 hours.

1. Press **ON/OFF** key and touch **Oven Modes**.
2. Scroll and touch **Delay Start**.

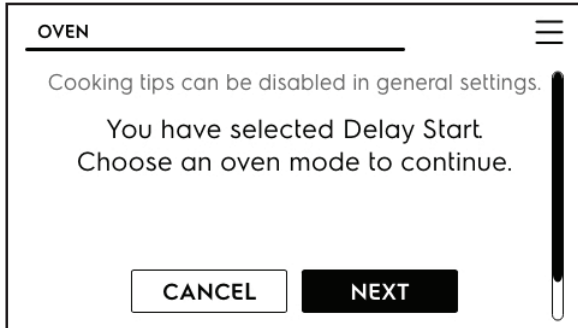

3. Touch **NEXT** and scroll Oven Modes to **Self Clean**. Follow the information on the screen to set delay time and self clean time.

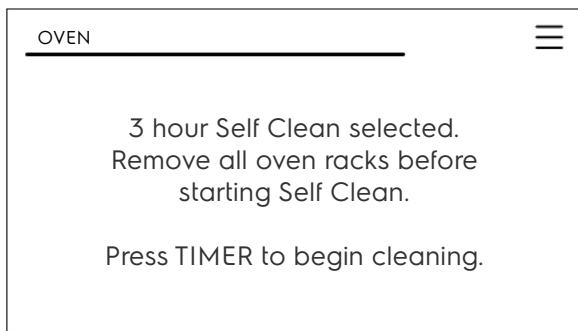
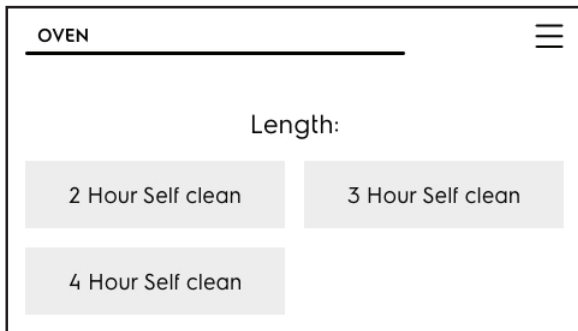

If it becomes necessary to stop self clean when active:

Press **OFF**.

- If self clean has heated the oven to a high temperature, allow enough time for the oven to cool.
- Before restarting self clean, be sure to read important notes below.

Important notes

- If self clean was active and then interrupted by a power failure or cancelled before the oven was thoroughly cleaned, it may be necessary to run another self clean cycle.
- If the oven temperature was high enough when self clean was interrupted, the oven control may not allow another self clean cycle to be set for up to 4 hours.

Steam Clean

The Steam Clean feature offers a chemical-free and time-saving method to assist in the routine cleaning of small and light soils. For heavier, baked on soils, use the Self Clean feature.

CAUTION

Do not add bleach, ammonia, oven cleaner, or any other abrasive household cleaners to the water used for Steam Clean.

Before cleaning any part of the oven, be sure all controls are turned off and the oven is cool. The oven may be hot and can cause burns.

Be sure the oven is level and cool before starting Steam Clean. If the oven temperature is above room temperature, a triple beep will be heard and the function will not start. Steam Clean produces best results when started with a cool oven.

To set a Steam Clean cycle:

1. Remove all racks and oven accessories.
2. Scrape or wipe loose debris and grease from the oven bottom.
3. Pour 2 ½ cup of tap water onto the oven bottom. Close oven door.

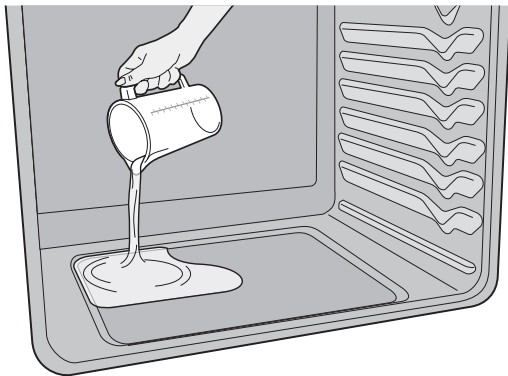

Figure 17: Add 2 ½ cups of tap water

4. Touch **Oven Modes**, scroll to and touch **Steam Clean**.
5. Touch **START**.
6. The time Steam Clean cycle will end is shown in the display. Do not open the door during this time.
7. When the steam clean cycle is complete an alert will sound and the Off message will show in the display. Press off to return to the clock.

8. Take care opening the door when the steam clean is finished. Stand to the side of the oven out of the way of escaping vapor.
9. Wipe oven cavity and bottom. Do not clean oven door gasket. Avoid leaning or resting on the oven door glass while cleaning cavity.

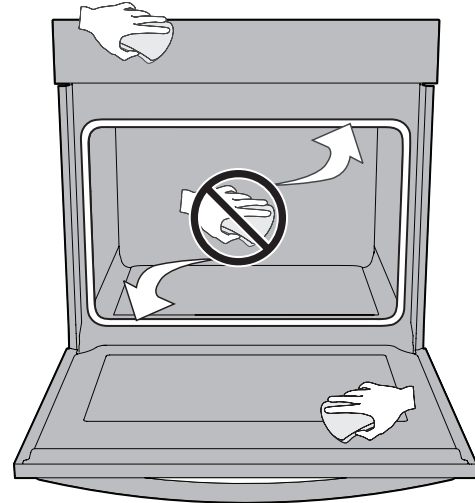

Figure 18: Clean around the oven door gasket

Notes:

- Opening the oven door during the steam clean cycle prevents the water from reaching the temperature needed to clean.
- For best results, clean oven immediately after the cycle is complete. Steam Clean works best for soils on the oven bottom.
- A non-abrasive scouring pad, stainless steel sponge, plastic scraper, or eraser style cleaning pad (without cleaner) can be used for difficult soils. Moisten pads with water before use.
- Place a paper towel or cloth in front of the oven to capture any water that may spill while wiping out.
- Do not leave the residual water in the oven for any length of time.
- Some condensation or water vapor may appear close to the oven vent and the oven door glass. This is normal. The oven gasket may become damp; do not wipe dry.
- Local water sources often contain minerals (hard water). If hard water deposits occur, wipe cavity with a 50/50 solution of water and vinegar or 50/50 solution of lemon juice and water.
- If Steam Clean results are not satisfactory, run a Self Clean. See “Self Clean” on page 40.

44 SETTING OVEN CONTROLS

Cooking with Food Probe

Use the probe feature for best results when cooking foods such as roasts, hams, or poultry.

The Food Probe works with the following oven modes: Bake, Convection Bake, Air Fry, Convection Roast, Steam Roast, and Turkey.

The probe feature, when set correctly, will signal an alert when the internal food temperature reaches the desired set target temperature. The probe settings for how the oven behaves should be set first in the oven menu.

When active, the probe displays the internal food temperature which is visible in the display during the cooking process. This eliminates any guesswork or the need to open the oven door to check the thermometer.

For meats like poultry and roasts, using a probe to check internal temperature is the safest method to ensure properly cooked food.

To set Food Probe:

- Touch **Oven Modes**, scroll to **Food Probe** and follow directions on the display.



CAUTION

Do not use kitchen utensils to pull on the probe cable or handles. Always insert and remove the probe using the provided handles, as shown in and always use a pot holder to protect hands from possible burns.

Proper placement of probe in food.

Insert the probe so that the probe tip rests inside the center of the thickest part of meat or food. For best results, do not allow the probe temperature sensor to contact bone, fat, gristle, or the cookware.



- For bone-in ham or lamb, insert the probe into the center of lowest large muscle or joint.
- For meat loaf or casseroles, insert the probe into center of food.
- When cooking fish, insert meat probe just above the gill.
- For whole poultry or turkey, fully insert the probe sensor into the thickest part of the breast.

Using the Food Probe for Turkey

1. Select **Oven Modes** and scroll to **Food Probe**.
 - The display will remind you to insert the probe into the turkey and place in oven on rack position 1.
 - Display reminds you to connect the food probe to the receptacle before setting oven mode:
2. Touch **NEXT**.
3. Touch **Turkey** in Oven Modes.
4. Set target food temperature after pressing **NEXT**.
5. Set oven temperature and press **START**.

When the target temperature of the turkey (internal temperature) is reached, the oven will turn off if set for cooking to stop in the Oven Menu settings.

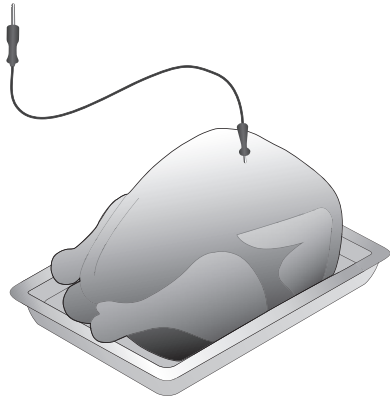

NOTE

During cooking, the internal food temperature will display in the center of the screen. The oven temperature will be displayed at the bottom of the screen beside the cancel key. To ensure accuracy, do not remove the probe from the food or receptacle until the desired internal temperature is reached.

If the probe is removed from the receptacle only, the probe feature will cancel and the oven will turn off. If the probe is removed from the food only, the probe feature will remain active and may eventually generate a probe too hot message.

To change the target (internal food) temperature or the set oven temperature touch the one you want to change and use the (+) or (-) to adjust the temperature.

Table 7: USDA recommended minimum internal cooking temperatures

Food Type	Internal Temp.
Ground meat and meat mixtures	
Beef, Pork, Veal, Lamb	160°F (71°C)
Turkey, Chicken	165°F (74°C)
Fresh beef, veal, lamb	
Medium rare	145°F (63°C)
Medium	160°F (71°C)
Well Done	170°F (77°C)
Chicken and Turkey, whole	165°F (74°C)
Poultry Breasts, Roasts	165°F (74°C)
Poultry Thighs, Wings	165°F (74°C)
Stuffing (cooked alone or in bird)	165°F (74°C)
Ham Fresh (raw)	160°F (71°C)
Ham Pre-cooked (to reheat)	140°F (60°C)
Eggs dishes	160°F (71°C)
Leftovers and Casseroles	165°F (74°C)

The U.S. Department of Agriculture states, "Rare fresh beef is popular, but you should know that cooking it to only 140°F (60°C) means some food poisoning organisms may survive." (Source: Safe Food Book, Your Kitchen Guide, USDA) Visit the USDA Food Safety and Inspection website at www.fsis.usda.gov.

IMPORTANT

Do not store the probe inside the oven. Use only the original probe provided. Connecting any other probe or device could result in damage to the oven control, electronics, and the receptacle.

Before starting self clean, double check that the probe is removed from the oven interior. Defrost frozen foods completely before inserting the probe.

46 SETTING OVEN CONTROLS

Setting the Sabbath Feature for the Jewish Sabbath and Holidays

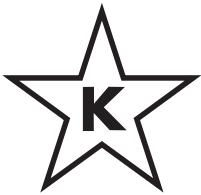

For further assistance, guidelines for proper usage, and a complete list of models with the Sabbath feature, please visit the web at www.star-k.org.

This appliance provides special settings for use when observing the Jewish Sabbath/Holidays. Sabbath mode disables all audible tones or visual display changes on the oven control. Bake is the only cooking feature available while in the Sabbath mode. Most oven controls are locked during Sabbath mode.

To start Sabbath Mode, first select Sabbath from the settings menu. Next, select Delay (if desired), Bake temperature, and cook time (if desired) and set. Cooking will begin after any specified delay.

If cook time was set, once the time has elapsed, the cooking will end and the display will show **Idle** to indicate that the cook time has ended.

Important: The Sabbath mode will override the factory preset 12 hour energy saving mode, and the appliance will stay on until the cooking features are cancelled. If cooking is cancelled when the appliance is in the Sabbath mode, no audible or visual indicators will be available to verify the cancellation.

If the oven interior lights are needed, be sure to activate them prior to setting the Sabbath mode. Once the oven light is turned on and the Sabbath mode is active, the oven light will remain on until the Sabbath mode is turned off and the oven lights are turned off. The oven door will not activate the interior oven lights when the oven door is opened or closed.

It is recommended that any oven temperature modification made within an active Sabbath mode press the (+) or (-) key.

The temperature will increase or decrease with each press by 5°F (1°C) and the change will be accepted automatically.

WARNING

Food poisoning hazard. Do not let food sit for more than one hour before or after cooking. Doing so can result in food poisoning or sickness. Foods that can easily spoil such as milk, eggs, fish, meat or poultry, should be chilled in the refrigerator first. Even when chilled, they should not stand in the oven for more than 1 hour before cooking begins, and should be removed promptly when finished cooking.

Important:

- Do not attempt to activate any other oven function except Bake while the Sabbath feature is active. When the Sabbath feature is active, only the (+) and (-) keys and OFF will function. ALL OTHER KEYS should not be used once the Sabbath feature is active.
- You may change the oven temperature once baking has started. Use the (+) and (-) keys to raise or lower the oven temperature. Each press of an arrow key will raise or lower the temperature by 5°F (1°C).
- Remember that the oven control will no longer provide audible tones or display any further changes when the Sabbath feature is active.
- The oven will shut-off automatically after completing a bake time and therefore may only be used once during the Sabbath/Jewish Holidays.

Setting Sabbath Mode:

Sabbath Mode is set using the **Menu Options**.

1. Touch the **Menu Options** bars.
2. Scroll to **Sabbath Mode**.
3. Touch **Sabbath Mode** and follow all instructions on screen.

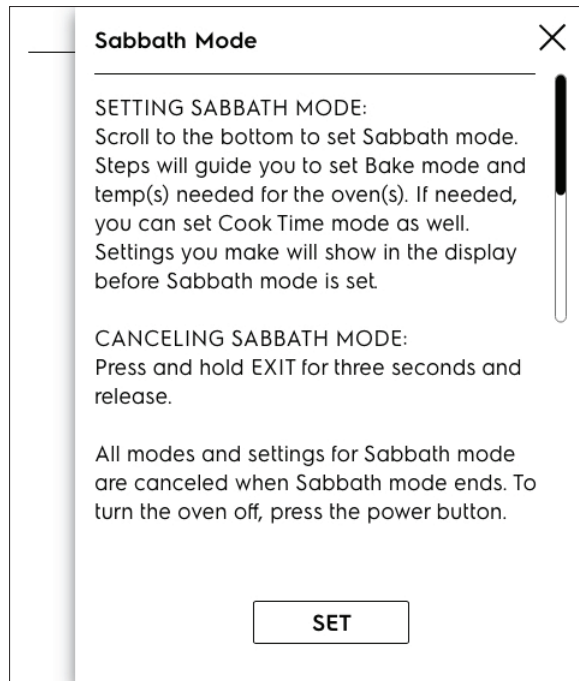

To exit Sabbath Mode, press and hold **EXIT** for three seconds.

48 CARE AND CLEANING

Remove spills and any heavy soiling as soon as possible. Regular cleaning will reduce the difficulty of major cleaning later.

! CAUTION

Before cleaning any part of the appliance, be sure all controls are turned off and the appliance is cool.

If ammonia or appliance cleaners are used, they must be removed and the appliance must be thoroughly rinsed before operating. Follow manufacturer's instructions and provide adequate ventilation.

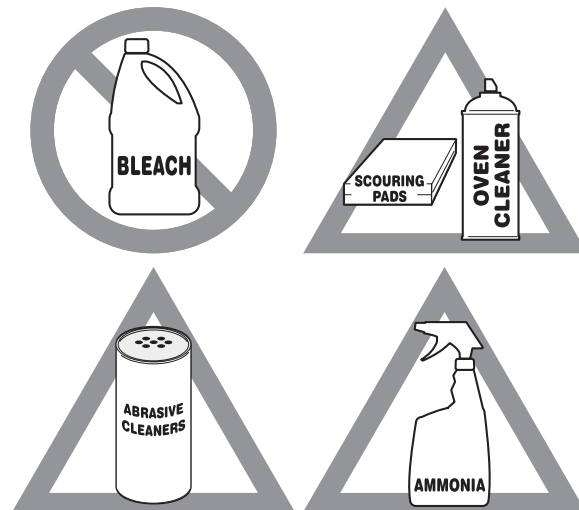

Figure 19: Use cleaners with caution

Surface or Area	Cleaning Recommendation
Aluminum and vinyl	Using a soft cloth, clean with mild dish detergent and water. Rinse with clean water, dry and polish with a soft, clean cloth.
Painted and plastic control knobs Painted body parts Painted decorative trims	Using a soft cloth, clean with mild dish detergent and water or a 50/50 solution of vinegar and water. Rinse with clean water, dry and polish with a soft, clean cloth. Glass cleaners may be used, but do not apply directly to surface; spray onto cloth and wipe.
Control panel	Using a soft cloth, clean with mild dish detergent and water or a 50/50 solution of vinegar and water. Do not spray liquids directly on the oven control and display area. Do not use large amounts of water on the control panel, excess water on the control area may cause damage to the appliance. Do not use other liquid cleaners, abrasive cleaners, scouring pads, or paper towels - they will damage the finish.
Control knobs	Using a soft cloth, clean with mild dish detergent and water or a 50/50 solution of vinegar and water. To remove control knobs: turn to the OFF position, grasp firmly, and pull off the shaft. To replace knobs after cleaning, line up the OFF markings and push the knobs into place.
Stainless Steel	Using a soft cloth, clean with mild dish detergent and water or a 50/50 solution of vinegar and water. Rinse with clean water, dry with a soft clean cloth. Do not use cleaners containing abrasives, chlorides, chlorine, or ammonia.
Oven racks & shelves	Oven racks must be removed. Clean using a mild, abrasive cleaner following the manufacturer's instructions. Rinse with clean water and dry.

Surface or Area	Cleaning Recommendation
<p>Porcelain-enameled broiler pan and insert</p> <p>Porcelain door liner</p> <p>Porcelain body parts</p>	<p>Rinse with clean water and a damp cloth. Scrub gently with a soapy, non-abrasive scouring pad to remove most spots. Rinse with a 50/50 solution of clean water and ammonia. If necessary, cover difficult spots with an ammonia-soaked paper towel for 30 to 40 minutes. Rinse and wipe dry with a clean cloth. Remove all cleaners or future heating could damage the porcelain.</p> <p>Do not allow food spills with a high sugar or acid content (milk, tomatoes, sauerkraut, fruit juices or pie filling) to remain on porcelain surfaces. These spills may cause a dull spot even after cleaning.</p>
<p>Manual clean oven interior</p>	<p>The oven interior is porcelain coated and safe to clean using oven cleaners. Always follow manufacturer's instructions for cleaners. After cleaning, remove any oven cleaner or the porcelain may become damaged during future heating.</p> <p>Do not spray oven cleaner on any electrical controls or switches. Do not spray or allow oven cleaner to build up on the oven temperature sensing probe. Do not spray cleaner on oven door trim, door gasket, plastic drawer glides, handles or any exterior surfaces of the appliance.</p>
<p>Self-cleaning oven interior</p>	<p>Before setting a self-clean cycle, clean soils from the oven frame, areas outside the oven door gasket, and the small area at the front center of the oven bottom. See "Self Clean" on page 40.</p>
<p>Oven door</p>	<p>Use mild dish detergent and water or a 50/50 solution of vinegar and water to clean the top, sides, and front of the oven door. Rinse well.</p> <p>Glass cleaner may be used on the outside glass of the door. Ceramic smoothtop cleaner or polish may be used on the interior door glass. Do not immerse the door in water. Do not spray or allow water or cleaners to enter the door vents. Do not use oven cleaners, cleaning powders, or any harsh abrasive cleaning materials on the outside of the oven door.</p> <p>Do not clean the oven door gasket. The oven door gasket is made of a woven material which is essential for a good seal. Do not rub, damage, or remove this gasket.</p>
<p>Gas cooktop surface burners</p>	<p>See "Cleaning the sealed burners" on page 50.</p>
<p>Gas cooktop surface grates</p> <p>Gas cooktop burner caps</p>	<p>Use a non-abrasive plastic scrubbing pad and mild abrasive cleanser. Do not allow food spills with a high sugar or acid content (milk, tomatoes, sauerkraut, fruit juices or pie filling) to remain on the burner grates or burner caps. These spills may cause a dull spot even after cleaning. Clean these spills as soon as surfaces are cool. Thoroughly dry immediately following cleaning.</p>

50 CARE AND CLEANING

Cleaning the sealed burners

To avoid possible burns, do not attempt cleaning before turning off all surface burners and allowing them to cool.

Any additions, changes, or conversions required in order for this appliance to satisfactorily meet the application needs must be made by an authorized qualified Agency. Routinely clean the cooktop. Wipe with a clean, damp cloth and wipe dry to avoid scratches. Keeping the surface burner head ports and slots clean will prevent improper ignition and an uneven flame.

To clean recessed and contoured areas of cooktop:

- If a spill occurs on or in the recessed or contoured areas, blot up spill with an absorbent cloth.
- Rinse with a clean, damp cloth and wipe dry.

CAUTION

To avoid possible burns do not attempt to operate the surface burners without the burner caps. Do not use spray oven cleaner on the cooktop.

To clean burner heads:

1. Remove the burner cap, burner head and burner cup (see Figure 20). Clean the cap, head and cup with hot soapy water and dry thoroughly.
2. For burned-on and dried spills, apply hot soapy water to the burner cap and head to allow time for the soils to soften.
3. Use a toothbrush to clean all over the burner head and cap.
4. Wipe the burner cap and head clean with a soft, clean cloth, sponge, or scratch-free cleaning pad. Wipe out injector nozzles with a cloth before placing burner head and cap back on. The burner assembly must be completely dry before use.
5. Make sure the burner caps and heads are placed and seated properly into the burner cup. When placed correctly, the burner cap should not move off the burner head (see "Assembly of the Burner" on page 14).
6. If burner fails to light, recheck placement of burner head to the orifice holder and cap.

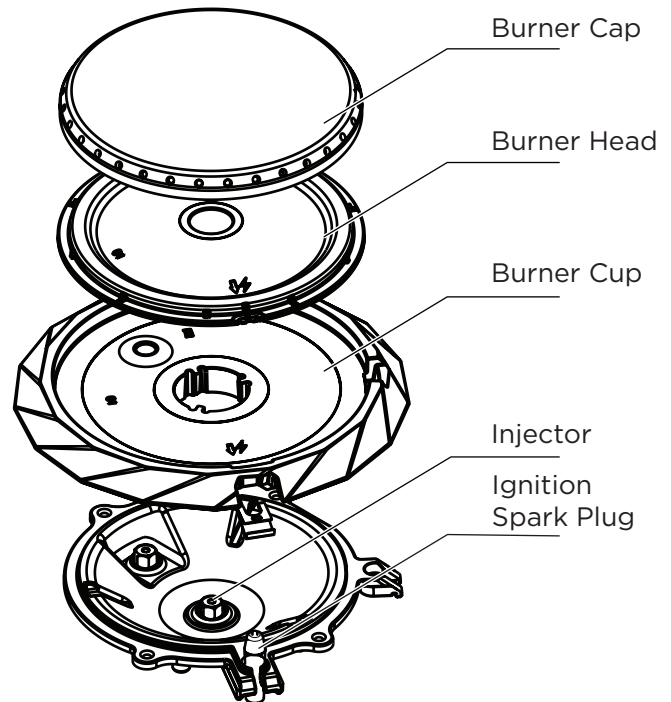

Figure 20: Removeable burner components

Important notes:

- Always keep the surface burner caps in place whenever a surface burner is in use.
- When replacing the burner caps, be sure the burner caps are seated firmly on top of the burner heads.
- For proper flow of gas and ignition of burners do not allow spills, food, cleaning agents, or any other material to enter the gas orifice port opening.

General Cleaning

Refer to the table at the beginning of this chapter for more information about cleaning specific parts of the oven.

Follow these cleaning precautions:

- Allow the oven to cool before cleaning.
- Wear rubber gloves when cleaning the appliance manually.
- Remove soils using hot, soapy water. Do not allow food spills with a high sugar or acid content (such as milk, tomatoes, sauerkraut, fruit juices or pie filling) to remain on the surface as they may cause a dull spot even after cleaning. Remove spillovers and heavy soiling as soon as possible. Regular cleaning will reduce the effort required for major cleaning later.



CAUTION

Before manually cleaning any part of the oven, be sure all controls are turned off and the oven is cool. The oven may be hot and can cause burns.

Remove all racks and accessories from the oven before cleaning.

Ammonia must be rinsed before operating the oven. Provide adequate ventilation.

Cleaning Porcelain Enamel Oven

The oven interior is porcelain on steel, it is safe to clean using oven cleaners.

To remove heavy soil:

1. Allow a dish of ammonia to sit in the oven overnight or for several hours with the oven door closed. Clean softened dirt spots using hot, soapy water. Rinse well with water and a clean cloth.
2. If soil remains, use a nonabrasive scouring pad or a nonabrasive cleaner. If necessary, use an oven cleaner following manufacturer's instructions. Do not mix ammonia with other cleaners.
3. Clean any soil from the oven frame, the door liner outside the oven door gasket and the small area at the front center of the oven bottom. Clean with hot, soapy water. Rinse well using clean water and a cloth.

52 CARE AND CLEANING

Aluminum Foil, Aluminum Utensils, and Oven Liners

WARNING

Never cover any slots, holes, or passages in the oven cavity or cover an entire oven rack with materials such as aluminum foil. Doing so blocks air flow through the oven and may cause carbon monoxide poisoning. Aluminum foil linings may trap heat, causing a fire hazard.

- Protective liners—Do not use aluminum foil to line the oven bottom. The high heat of the oven can melt these materials to the oven cavity and ruin the oven. These types of materials can also reduce the effectiveness of the air circulation in the oven and produce poor baking results. Only use aluminum foil as recommended in this manual. Improper installation of these liners may result in risk of electric shock or fire.
- Aluminum utensils - The melting point of aluminum is much lower than that of other metals. Care must be taken when aluminum pots or pans are used.
- Oven racks - Do not use aluminum foil to cover the oven racks. Using a liner in the oven restricts the heat and air flow needed to obtain the best possible cooking results for any oven.

Replacing the Oven Light

CAUTION

Be sure the oven is unplugged and all parts are cool before replacing the oven light.

The interior oven light is located at the rear of the oven cavity and is covered by a glass shield. The glass shield must be in place whenever the oven is in use.

To replace the oven interior light bulb:

1. Turn electrical power off at the main source or unplug the appliance.
 2. Remove interior oven light shield by turning counter-clockwise.
 3. Replace bulb with a new halogen 40 watt appliance bulb.
-  **NOTE**
- Wear a cotton glove or use a paper towel when installing a new bulb. Do not touch the new bulb with your fingers when replacing. This will shorten the life of the bulb.
4. Replace glass oven light shield by rotating clockwise.
 5. Turn power back on again at the main source (or plug the appliance back in).
 6. Be sure to reset the time of day on the clock.

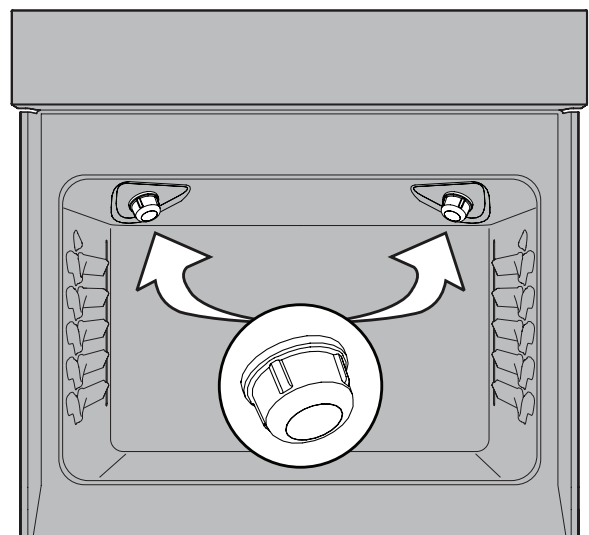

Figure 21: Oven Halogen light

Removing and Replacing the Oven Door

! IMPORTANT

Special door care instructions - Most oven doors contain glass that can break. Do not hit the glass with pots, pans, or any other object. Scratching, hitting, jarring, or stressing the glass may weaken its structure, causing an increased risk of breakage at a later time. Do not close the oven door until all of the oven racks are fully in place.

To remove the oven door:

1. Open oven door completely, horizontal with floor (Figure 22).
2. Push down the hinge locking tab on both sides of door (figure 23).
3. Grasp the door by the sides, and close the door until it stops in partially open position on the locking tab (Figure 24).
4. Pull the door toward you while rotating the top of the door toward the appliance to completely disengage the hinge levers (Figure 25).

To replace the oven door:

1. Firmly grasp both sides of oven door along the door sides. Do not use the oven door handle (Figure 25).
2. Hold the oven door at the same angle as the removal position (Figure 24). Carefully insert the hinge levers into the oven frame until you feel the hinge levers are seated into the hinge notches. The hinge arms must be fully seated into the hinge notches before the oven door can be fully opened.
3. Fully open the oven door, horizontal with floor (Figure 22).
4. Push the door hinge locks up, to their normal position on both left and right sides of door (Figure 23).
5. Close the oven door.

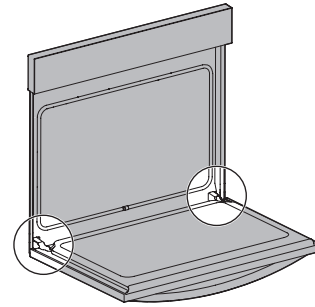

Figure 22: Door hinge location

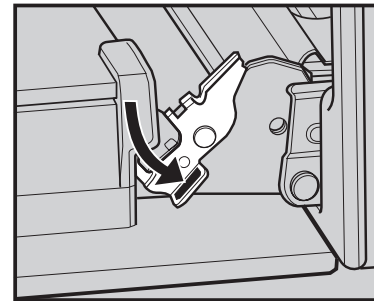

Figure 23: Door hinge lock

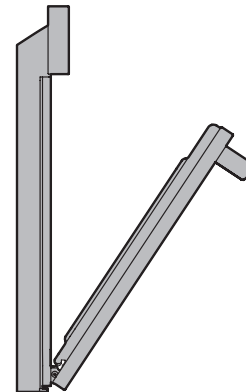

Figure 24: Removal position

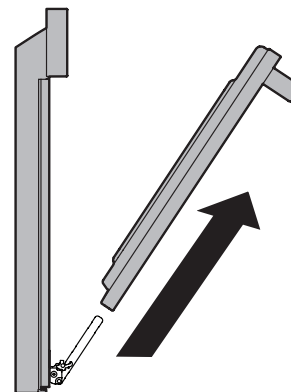







Figure 25: Remove the door

54 BEFORE YOU CALL

Oven Baking

For best cooking results, preheat the oven before baking cookies, breads, cakes, pies, pastries, etc. There is no need to preheat the oven for roasting meat or baking casseroles. The cooking times and temperatures needed to bake a product may vary slightly from your previously owned appliance.

Baking Problems and Solutions		
Baking Problems	Causes	Corrections
Cookies and biscuits burn on the bottom. 	Cookies and biscuits put into oven before oven is preheated.	Allow oven to preheat to desired temperature before placing food in oven. Choose pan sizes that will permit at least 2" (5.1 cm) of air space.
Cakes too dark on top or bottom 	Cakes put in oven before oven is preheated. Rack position too high or too low. Oven too hot.	Allow oven to preheat to the selected temperature before placing food in the oven. Use proper rack position for baking needs. Set oven temperature 25°F (13°C) lower than recommended.
Cakes not done in center 	Oven too hot. Incorrect pan size. Pan not centered in oven. Glass cookware (slow heat conductor).	Set oven temperature 25°F (13°C) lower than recommended. Use pan size suggested in recipe. Use proper rack position and place pan so there are at least 2" (5.1 cm) of space on all sides of pan. Reduce temperature and increase cook time or use shiny bakeware.
Cakes not level. 	Oven not level. Pan too close to oven wall or rack overcrowded. Pan warped. Oven light left on while baking.	Place a marked glass measuring cup filled with water on the center of the oven rack. If the water level is uneven, refer to the installation instructions for leveling the oven. Use proper rack position and place pan so there are at least 2" (5.1 cm) of space on all sides of pan. Do not use pans that are dented or warped. Do not leave the oven light on while baking.
Foods not done when cooking time is over. 	Oven too cool. Oven overcrowded. Oven door opened too frequently.	Set oven temperature 25°F (13°C) higher than suggested and bake for the recommended time. Be sure to remove all pans from the oven except the ones to be used for baking. Open oven door only after the shortest recommended baking time.



Let us help you troubleshoot your concern! This section will help you with common issues. If you need us, visit our website, chat with an agent, or call us. We may be able to help you avoid a service visit. If you do need service, we can get that started for you!

1-800-374-4432 (United States)
Frigidaire.com

Problem	Cause / Solution
Entire appliance does not operate	Appliance not connected. Make sure power cord is plugged properly into outlet. Check your fuse box or breaker box to make sure the circuit is active. Electrical power outage. Check house lights to be sure. Call your local electric company for service outage information.

Oven Problems	
Problem	Cause / Solution
Poor baking results.	Many factors affect baking results. Use proper oven rack position. Center food in the oven and space pans to allow air to circulate. Preheat the oven to the set temperature before placing food in the oven. Try adjusting the recipe's recommended temperature or baking time. Adjust the oven temperature if you feel the oven is too hot or too cool. See "Oven Temperature Calibration" on page 23.
Flames inside oven or smoking from oven vent.	Excessive spills in oven. Grease or food spilled onto the oven bottom or oven cavity. Wipe up excessive spills before starting the oven. If flames or excessive smoke are present when using broil, see "Broil" feature on page 35.
Oven smokes excessively when broiling.	Incorrect setting. Follow the "Broil" instructions on page 35. Meat too close to the broil element. Reposition the broil pan to provide proper clearance between the meat and broil element. Remove excess fat from meat. Cut remaining fatty edges to prevent curling, but do not cut into lean. Grease build up on oven surfaces. Regular cleaning is necessary when broiling frequently. Grease or food splatters will cause excessive smoking.
Oven portion of appliance does not operate.	The time of day is not set. The clock must be set in order to operate the oven. See "Set Clock" on page 21. Be sure the oven controls are set properly for the desired function. See "Oven Control Features" starting on page 22 and review instructions for the desired cooking function in this manual or see "Entire appliance does not operate." in this checklist.
Convection fan does not rotate.	Oven door is open. The convection fan will turn off if the oven door is opened when convection is active. Close the oven door.

56 BEFORE YOU CALL

Cooktop Problems	
Problem	Cause / Solution
Surface burners do not ignite.	<p>Surface control knob was not completely turned to “” (lite). Push in and turn the surface control knob to “” (lite) until the burner ignites and then turn the control knob to the desired flame size.</p> <p>Burner ports are clogged. With the burner OFF and cool, use a small-gauge wire or needle to clean the burner head slots and ignition ports. See “Cleaning the sealed burners” in the Care & Cleaning section on page 50 for additional cleaning instructions.</p> <p>Range power cord is disconnected from outlet (electric ignition models only). Be sure the power cord is securely plugged into the power outlet.</p> <p>Circuit is broken. Check breaker box or fuse box.</p> <p>Electrical power outage. Burners may be lit manually. See “Setting Surface Burners” on page 18.</p>
Surface burner flame uneven or only part way around burner cap.	<p>Burner slots or ports are clogged. With the surface burner OFF and cool, clean ports with a small-gauge wire or needle. If moisture is present after cleaning, lightly fan the flame and allow the burner to operate until flame is full.</p> <p>Burner caps are not seated properly. Check that all burner caps are level and seated correctly on the burner heads. See “Cleaning the sealed burners” in the Care & Cleaning section on page 50 for additional cleaning instructions.</p>
Surface burner flame is too high.	<p>Surface control knob is set too high. Adjust to a lower flame setting.</p> <p>Burner caps are not seated properly. Check that all surface burner caps are level and seated correctly on the surface burner heads. See “Cleaning the sealed burners” in the Care & Cleaning section on page 50 for additional cleaning instructions.</p> <p>Incorrect L.P. conversion. Refer to L.P. conversion kit instructions to correct.</p>
Surface burner flame is orange.	<p>Dust particles in main gas line. Allow the burner to operate a few minutes until flame turns blue. In coastal areas, a slightly orange flame is unavoidable due to salt content in the air.</p> <p>Incorrect L.P. conversion. Refer to L.P. conversion kit instructions to correct.</p>

Self-Clean Problems	
Problem	Cause / Solution
Self clean does not work.	Oven control not set properly. See “Setting Self Clean” on page 41.
Oven racks discolored or do not slide easily.	Oven racks left in oven cavity during self clean. Remove oven racks from oven cavity before starting a self-clean cycle. Clean by using a mild abrasive cleaner following manufacturer’s instructions. Rinse with clean water, dry, and replace in oven.
Soil not completely removed after self clean.	<p>Self clean was interrupted. Review instructions on “Self Cleaning” on page 40.</p> <p>Excessive spills on oven bottom. Remove excessive spills before starting self clean.</p> <p>Failure to clean soil from the oven frame, the door liner, outside the oven door gasket, and the small area at the front center of the oven bottom. These areas are not in the self-cleaning area, but get hot enough to burn on residue. Clean these areas before starting the self-cleaning cycle. Burned-on residue can be cleaned with a stiff nylon brush and water or a nylon scrubber. Be careful not to damage the oven gasket.</p>

Other Problems	
Problem	Cause / Solution
Appliance is not level.	<p>Be sure the floor is level, strong, and stable enough to adequately support the range. If the floor is sagging or sloping, contact a carpenter to correct the situation.</p> <p>Poor installation. Place the oven rack in the center of the oven. Place a level on the oven rack. Adjust the leveling legs at the base of the appliance until the rack is level.</p> <p>Kitchen cabinet alignment may make range appear not level. Be sure cabinets are square and have sufficient room for appliance clearance.</p>
Cannot move appliance easily. Appliance must be accessible for service.	<p>Cabinets not square or are built in too tightly. Contact the builder or installer to make the appliance accessible.</p> <p>Carpet interferes with appliance. Provide sufficient space so the appliance can be lifted over carpet. Installation over carpet is not advised. See the installation instructions for guidelines specific to your appliance.</p>
Oven light does not work.	Be sure the oven light is secure in the socket. See “Replacing the Oven Light” on page 52.

58 WARRANTY

Your appliance is covered by a one year limited warranty. For one year from your date of delivery, Electrolux will pay all costs for repairing or replacing any parts of this appliance that prove to be defective in materials or workmanship when such appliance is installed, used and maintained in accordance with the provided instructions.

Exclusions

This warranty does not cover the following:

1. Products with original serial numbers that have been removed, altered or cannot be readily determined.
2. Product that has been transferred from its original owner to another party or removed outside the USA or Canada.
3. Rust on the interior or exterior of the unit.
4. Products purchased "as-is" are not covered by this warranty.
5. Food loss due to any refrigerator or freezer failures.
6. Products used in a commercial setting.
7. Service calls which do not involve malfunction or defects in materials or workmanship, or for appliances not in ordinary household use or used other than in accordance with the provided instructions.
8. Service calls to correct the installation of your appliance or to instruct you how to use your appliance.
9. Expenses for making the appliance accessible for servicing, such as removal of trim, cupboards, shelves, etc., which are not a part of the appliance when it is shipped from the factory.
10. Service calls to repair or replace appliance light bulbs, air filters, water filters, other consumables, or knobs, handles, or other cosmetic parts.
11. Surcharges including, but not limited to, any after hour, weekend, or holiday service calls, tolls, ferry trip charges, or mileage expense for service calls to remote areas, including the state of Alaska.
12. Damages to the finish of appliance or home incurred during installation, including but not limited to floors, cabinets, walls, etc.
13. Damages caused by: services performed by unauthorized service companies; use of parts other than genuine Electrolux parts or parts obtained from persons other than authorized service companies; or external causes such as abuse, misuse, inadequate power supply, accidents, fires, or acts of God.

DISCLAIMER OF IMPLIED WARRANTIES; LIMITATION OF REMEDIES

CUSTOMER'S SOLE AND EXCLUSIVE REMEDY UNDER THIS LIMITED WARRANTY SHALL BE PRODUCT REPAIR OR REPLACEMENT AS PROVIDED HEREIN. CLAIMS BASED ON IMPLIED WARRANTIES, INCLUDING WARRANTIES OF MERCHANTABILITY OR FITNESS FOR A PARTICULAR PURPOSE, ARE LIMITED TO ONE YEAR OR THE SHORTEST PERIOD ALLOWED BY LAW, BUT NOT LESS THAN ONE YEAR. ELECTROLUX SHALL NOT BE LIABLE FOR CONSEQUENTIAL OR INCIDENTAL DAMAGES SUCH AS PROPERTY DAMAGE AND INCIDENTAL EXPENSES RESULTING FROM ANY BREACH OF THIS WRITTEN LIMITED WARRANTY OR ANY IMPLIED WARRANTY. SOME STATES AND PROVINCES DO NOT ALLOW THE EXCLUSION OR LIMITATION OF INCIDENTAL OR CONSEQUENTIAL DAMAGES, OR LIMITATIONS ON THE DURATION OF IMPLIED WARRANTIES, SO THESE LIMITATIONS OR EXCLUSIONS MAY NOT APPLY TO YOU. THIS WRITTEN WARRANTY GIVES YOU SPECIFIC LEGAL RIGHTS. YOU MAY ALSO HAVE OTHER RIGHTS THAT VARY FROM STATE TO STATE.

If You Need Service

Keep your receipt, delivery slip, or some other appropriate payment record to establish the warranty period should service be required. If service is performed, it is in your best interest to obtain and keep all receipts. Service under this warranty must be obtained by contacting Electrolux at the addresses or phone numbers below.

This warranty only applies in the USA and Canada. In the USA, your appliance is warranted by Electrolux Major Appliances North America, a division of Electrolux Home Products, Inc. In Canada, your appliance is warranted by Electrolux Canada Corp. Electrolux authorizes no person to change or add to any obligations under this warranty. Obligations for service and parts under this warranty must be performed by Electrolux or an authorized service company. Product features or specifications as described or illustrated are subject to change without notice.

USA
1-800-374-4432

Frigidaire
10200 David Taylor Drive
Charlotte, NC 28262

FRIGIDAIRE®

FRIGIDAIRE®

welcome home

Our home is your home. Visit us if you need help with any of these things:



owner support



accessories



service



registration

(See your registration card for more information.)

Frigidaire.com
1-800-374-4432