



30" Gas Range with Quick Boil

Gas Range

Available Products: FCRG3062AB, FCRG3062AS, FCRG3062AW

Available Colors: Black, Stainless Steel, White

Version: 09/23

Product Specifications

Cooking Controls

Bake	Yes
Broil	Yes
Clock	Yes
Cook Time	Yes
Delay Clean	Yes
Delay Start	Yes
Keep Warm	Yes
Kitchen Timer	Yes
Light	Yes
Lockout	Yes
Off	Yes
Oven Light	Yes
Set Clock	Yes
Start	Yes
Steam Clean	Yes
Temperature Display	Yes
Timer On / Off	Yes
Up / Down Arrow	Yes
User Preferences	Yes

Oven

Bake Element	17000 BTU
Broil Element	1400 Watts
Broil Element Pass	6
Number of Rack Positions	6
Oven Interior Color	Midnight Black
Oven Light Quantity	1
Oven Light Type	Halogen
Oven Light Watts	40 Watts
Rack Position Type	Embossed
Rack Type 1	Flat
Rack Type 1 Quantity	2

Cooktop Performance

Right Front Element Burner	18000 BTU
Right Rear Element Burner	5000 BTU
Left Front Element Burner	14000 BTU
Left Rear Element Burner	10000 BTU
Center Rear Element Burner	10000 BTU

Controls

Control Lock	Yes
--------------	-----

Cooking Controls Function

Adjustable Volume Feedback	Yes
Change between Continuous Bake Setting or 12-Hour	Yes
Energy Saving Feature	
Delayed Bake	Yes
Program Fahrenheit or Celsius	Yes

Cooktop

Cooking Surface Type	Gas
Grate Material	Cast Iron
Grate Quantity	3
Grate Style	Continuous

Drawer

Drawer Handle Style	Integrated
Drawer Type	Storage

Display

Control Location	Rear
Display Interface Color	White
Display Type	Membrane

Electrical Specifications

Minimum Circuit Required	12 Amps
Voltage Rating	120 V

General Specifications

Prop 65 Label	Yes
Warranty - Labor	1 Year
Warranty - Parts	1 Year

30" Gas Range with Quick Boil

Gas Range

Available Products: FCRG3062AB, FCRG3062AS,

Available Colors: Black, Stainless Steel, White

FCRG3062AW

Version: 09/23

Dimensions and Volume

Minimum Height	46 3/4"
Maximum Height	47 3/4"
Width	30"
Depth	26"
Depth With Door 90° Open	47 5/16"
Depth With Handle	28 1/2"
Oven Interior Height	17 5/8"
Oven Interior Width	25 3/16"
Oven Interior Depth	19 7/8"
Oven Capacity	5.1 Cu. Ft.

Installation

Adjustable Leveling Legs	Yes
Power Cord Included	Yes

Safety Certifications and Approvals

CSA Listed	Yes
------------	-----

Installation Diagram

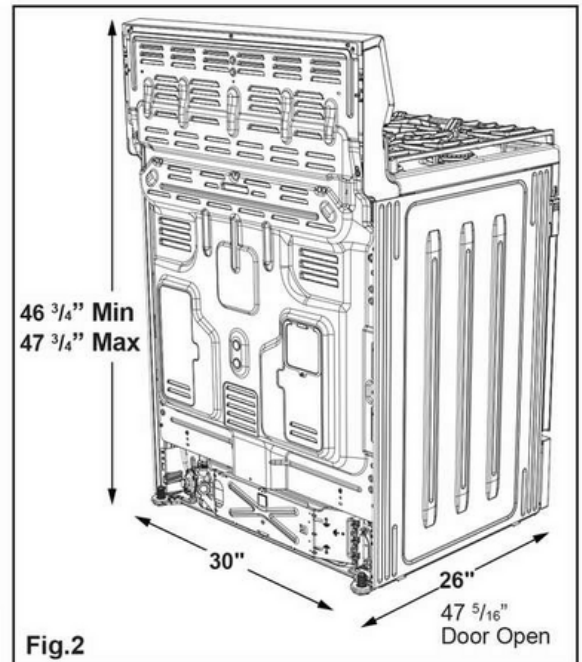
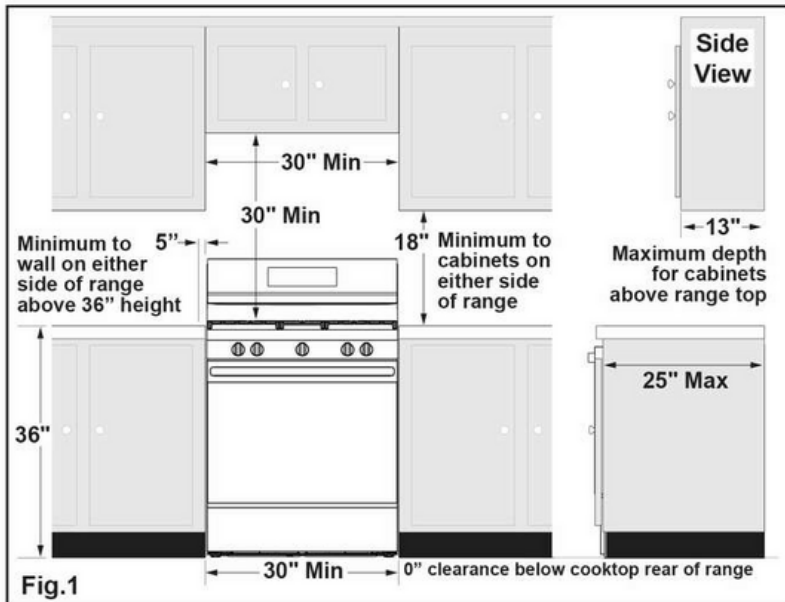

*30" (762 mm) MINIMUM CLEARANCE BETWEEN THE TOP OF THE COOKING SURFACE AND THE BOTTOM OF AN UNPROTECTED WOOD OR METAL CABINET; OR 24" (610 mm) MINIMUM WHEN BOTTOM OF WOOD OR METAL CABINET IS PROTECTED BY NOT LESS THAN 1/4" (6 mm) FLAME RETARDANT MILLBOARD COVERED WITH NOT LESS THAN NO. 28 MSG SHEET STEEL, 0.015" (0.4 mm) STAINLESS STEEL, 0.024" (0.6 mm) ALUMINUM OR 0.020" (0.5 mm) COPPER. 0" (0 mm) CLEARANCE IS THE MINIMUM FOR THE REAR OF THE RANGE. FOLLOW ALL DIMENSION REQUIREMENTS PROVIDED ABOVE TO PREVENT PROPERTY DAMAGE, POTENTIAL FIRE HAZARD, AND INCORRECT COUNTERTOP AND CABINET CUTS.

