



SENZA

INSTALLATION GUIDE

FVN9148

CONTENTS:

Mirror	FMC8010	PAGE 3
Cabinet	FCB9148	PAGE 5
Sink	FVS9048WH	PAGE 5

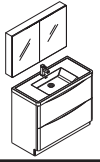

FVN9148
SENZA
INSTALLATION GUIDE



FVN9148
Vanity Front

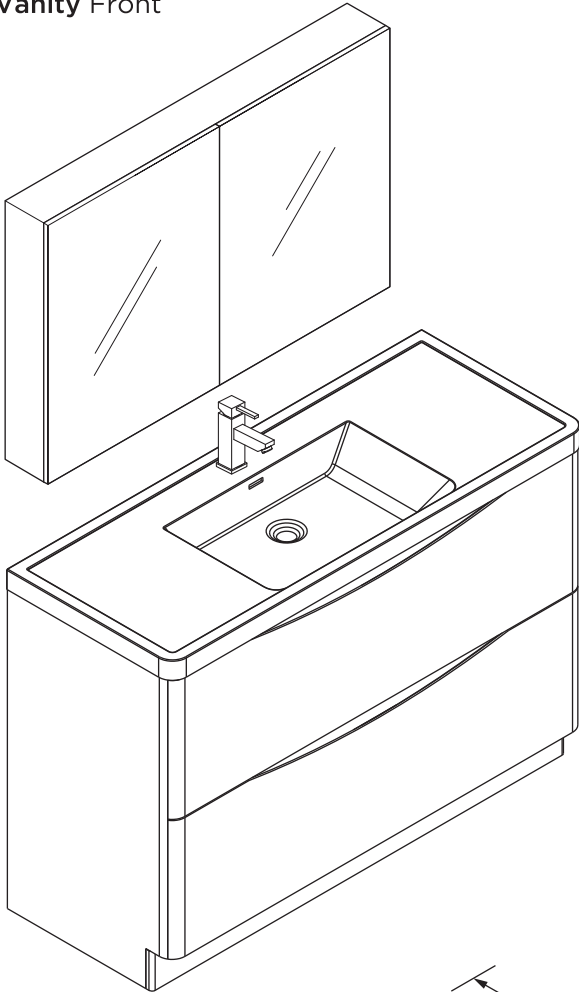

FMC8010
Medicine Cabinet Front

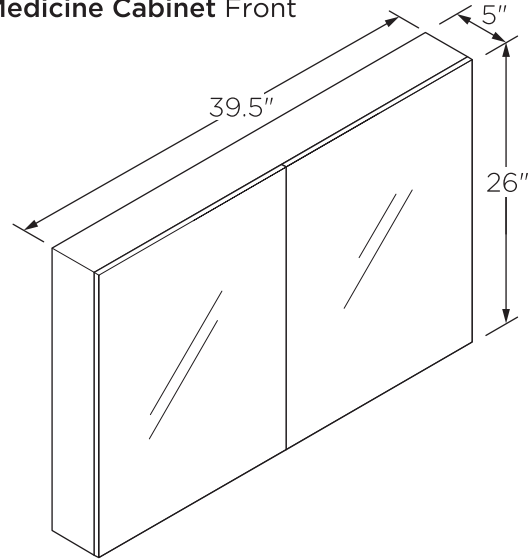

FVS9048WH
Counter Top Front

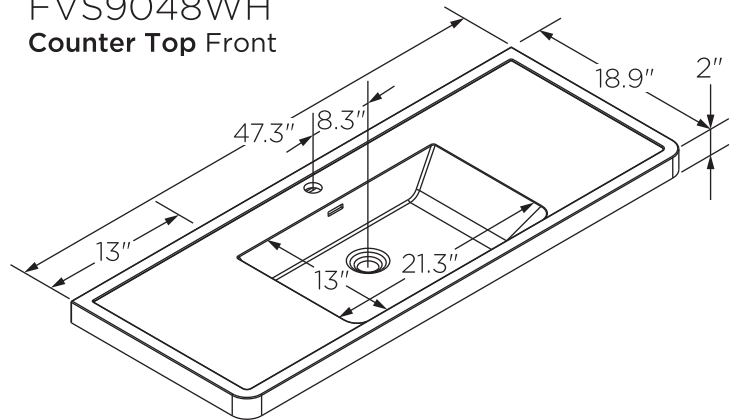

FCB9148
Cabinet Front

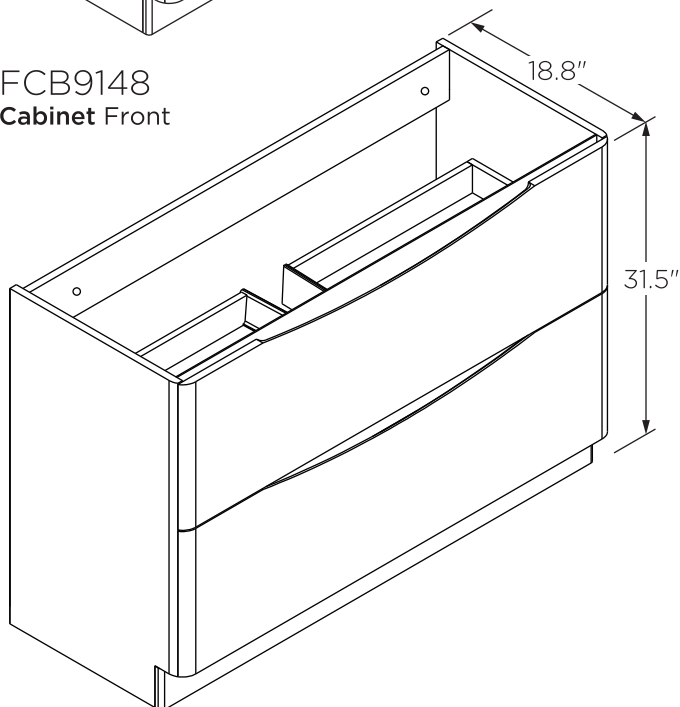

FCB9148
Cabinet Back

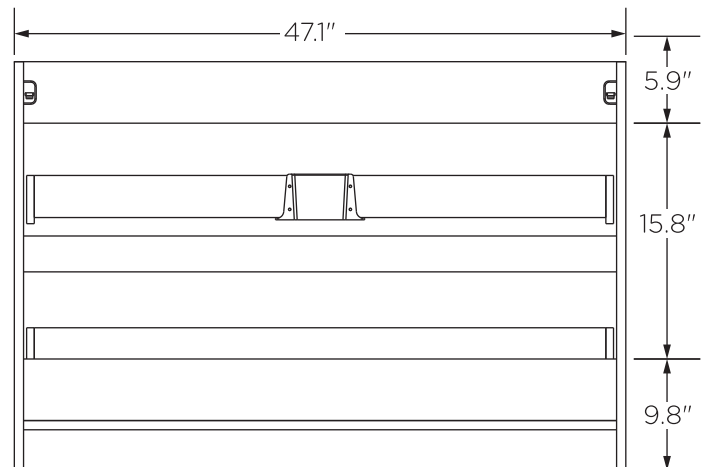

NOTE: All dimensions & specifications are approximate and subject to change without notice.

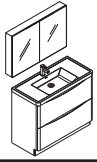

FVN9148 SENZA INSTALLATION GUIDE



TOOLS FOR ASSEMBLY

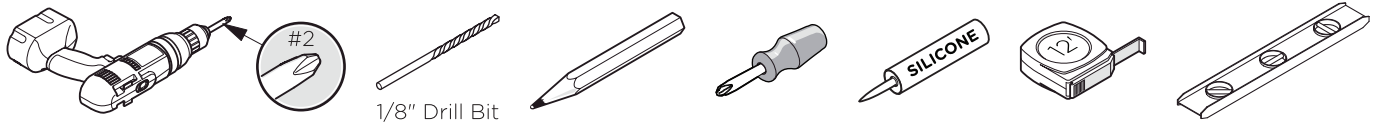

SUPPLIED PARTS

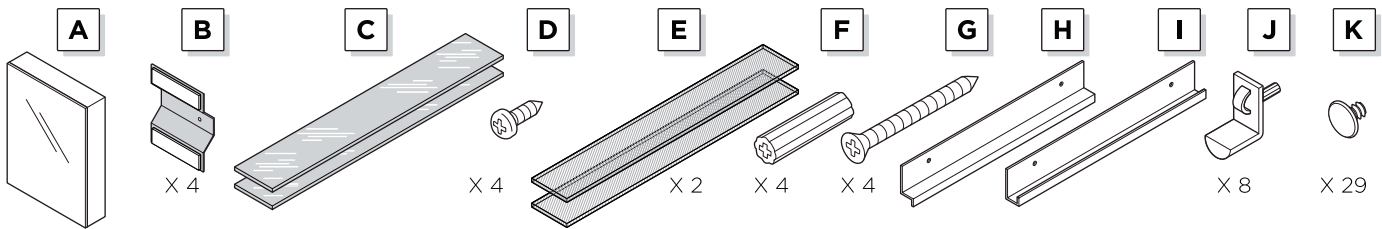

Your item may appear slightly different from the illustration

MEDICINE CABINET DIMENSIONS

Model SKU	Width A	Height B	Depth
FMC8058	19.5"	26"	5"
FMC8090	29.5"	26"	5"
FMC8010	39.5"	26"	5"

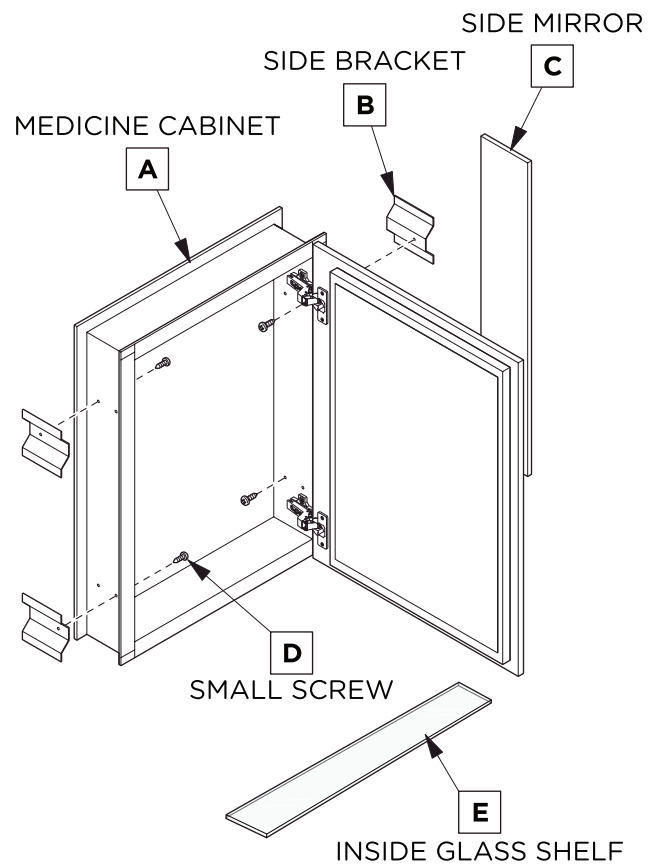
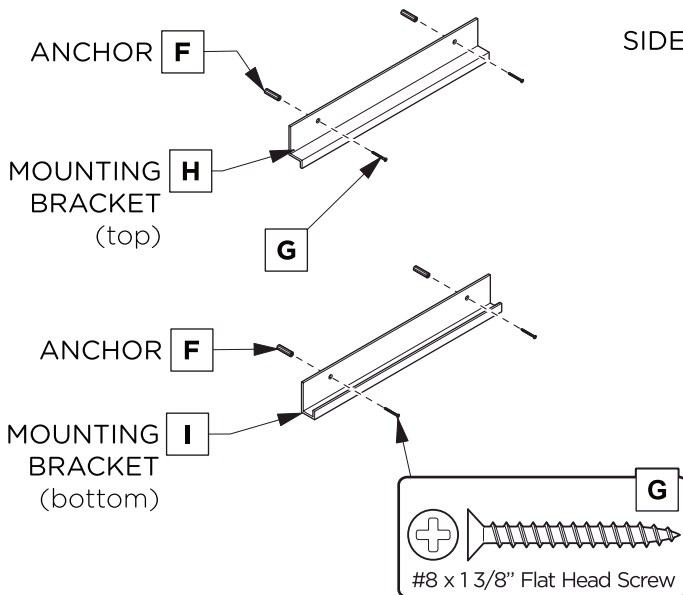

DANGER:

Risk of electronic shock. Avoid existing electrical wiring or plumbing when mounting this product to the wall.



WARNING:

Risk of property damage. Use anchors rated for the loaded weight of the product. Refer to the anchor manufacturer's instructions.

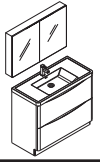

SURFACE-MOUNT INSTALLATION

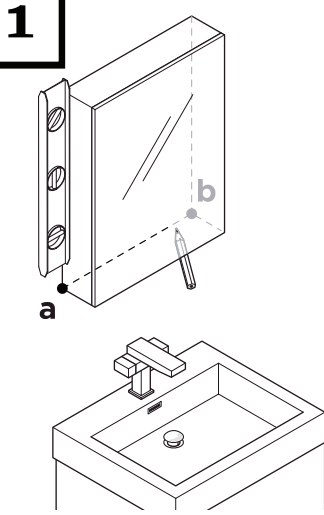

Level and mark the medicine cabinet's location on the wall from point **a** to point **b**.

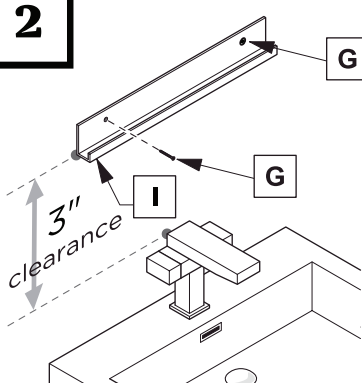

Level and mark.

IMPORTANT:
Consult an expert for the proper screws/bolts to use when attaching to various constructions. Screws provided **do not** attach to all wall construction types. Anchors are not required if brackets are installed in stud.

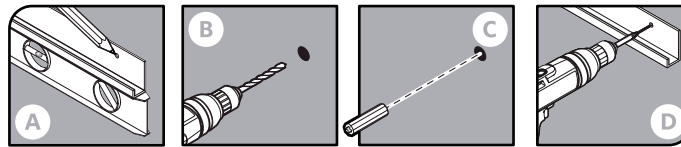

Drill the holes in the wall with a 3/16" drill bit. Insert the anchors in the holes. Attach bottom bracket to the wall.

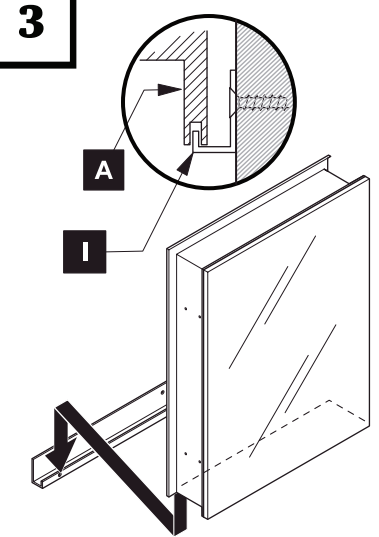

With assistance, rest the medicine cabinet on the bottom mounting bracket and hold it in place.

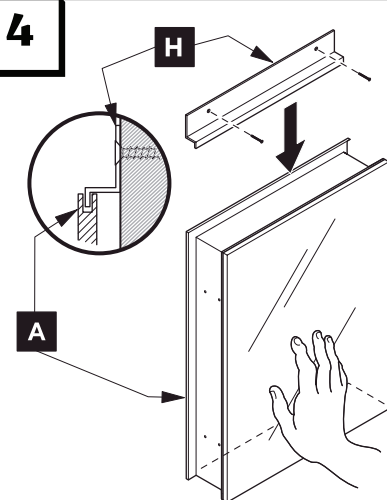

Hold the medicine cabinet (**A**) while it's placed on the bottom bracket, then secure by fitting the top bracket (**H**) on top of the medicine cabinet, and attach the top bracket (**H**) to the wall.

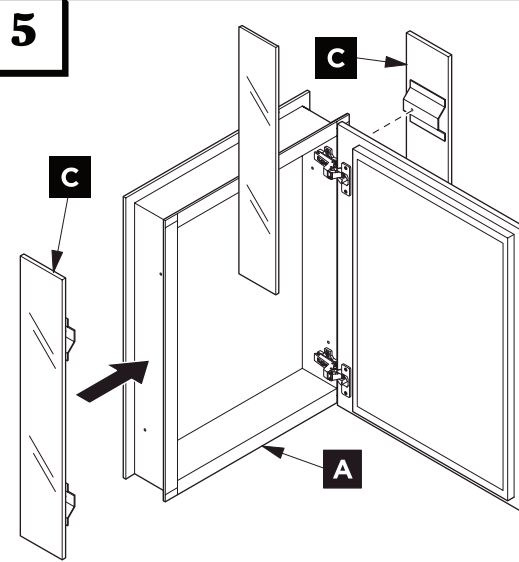

Align mirrored side panels (**C**) to each side of the medicine cabinet.

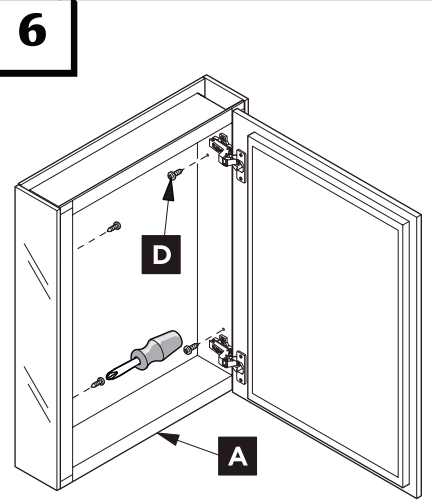

Attach mirrored side panels to the medicine cabinet using a screwdriver and provided screws (**D**).

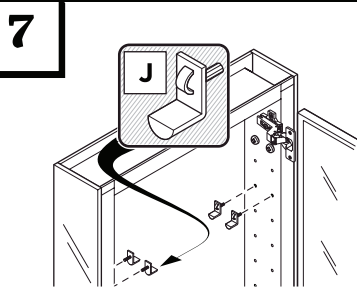

Push and twist the snap-in pins (**J**) into place.

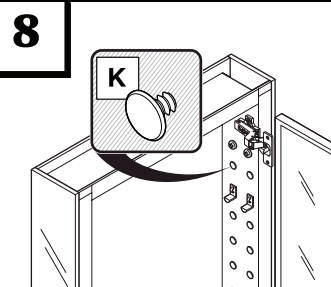

Fill remaining holes with the plugs (**K**).

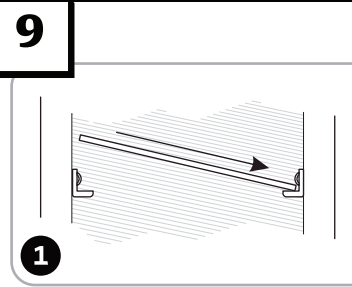

Push a side of the shelf (**E**) into left or right pins (**J**).

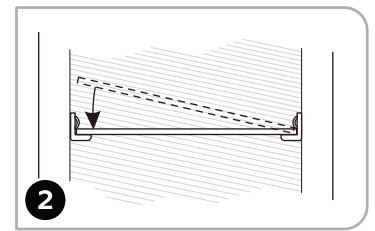

Snap the shelf (**E**) down into the opposite side.

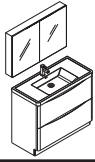

FVN9148 SENZA INSTALLATION GUIDE



RECESS-MOUNT INSTALLATION

1

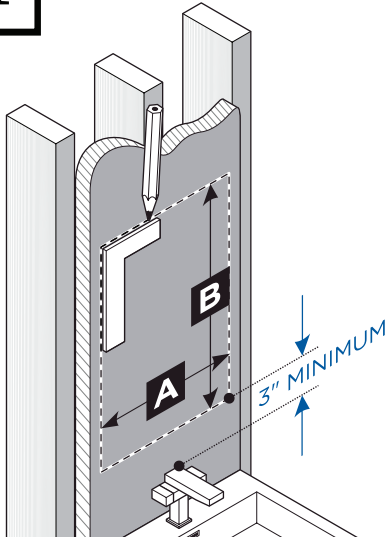

Draw the perimeter of the medicine cabinet on the wall.

2

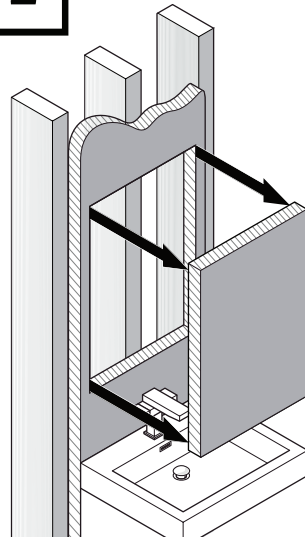

Place and hold the medicine cabinet in the cutout opening.

3

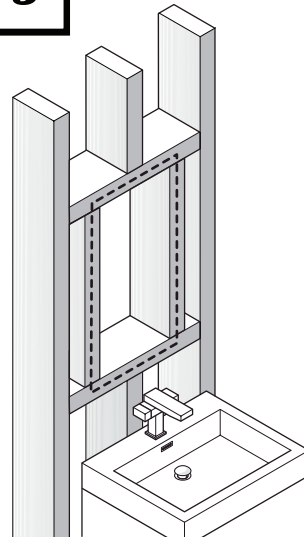

Frame the cutout opening.

4

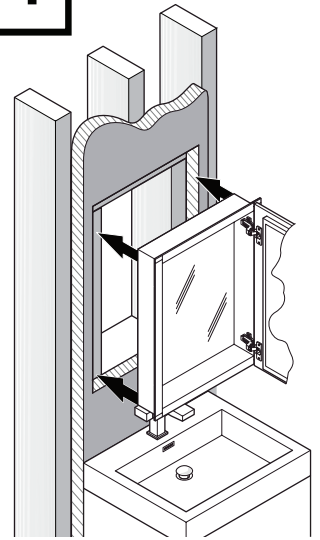

Cut the marked perimeter with appropriate tool.

ROUGH IN DIMENSIONS

Model SKU	Width A	Height B	Depth
FMC8058	19.5"	26"	5"
FMC8090	29.5"	26"	5"
FMC8010	39.5"	26"	5"

4 STEPS TO FRAME THE CUTOUT OPENING

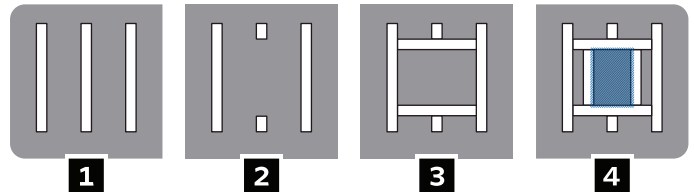

5

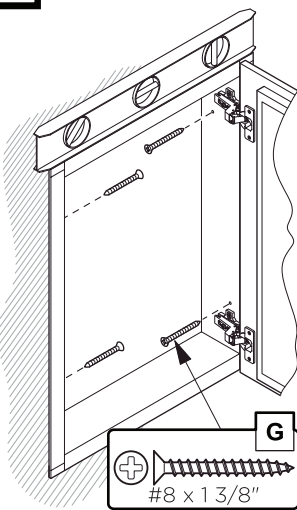

Level, then secure the medicine cabinet with the screws (**G**) through the mounting holes into the framing studs.

6

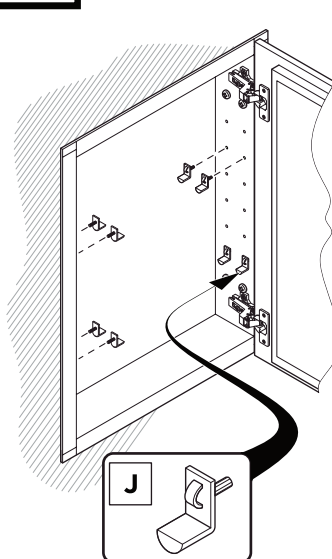

Choose the position for your shelves then push and twist the snap-in pins (**J**) into place.

7

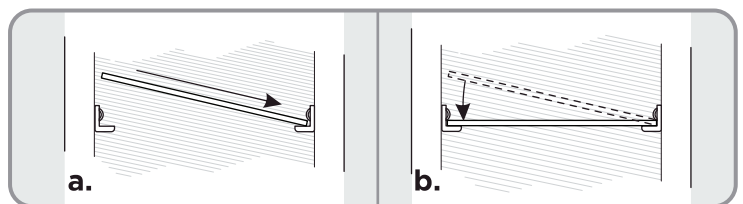

a. Push a side of the glass shelf (**C**) into left or right pins (**J**).

b. Snap the glass shelf (**C**) into the opposite side.

c. Fill remaining holes with the plugs (**K**).

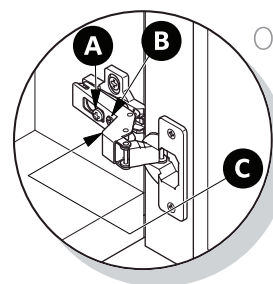
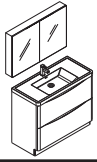

Illustration A.

OPTIONAL DOOR ADJUSTMENT:

- A** This screw allow you to adjust pitch side to side.
- B** This screw releases cabinet's door and allows up and down adjustment.
- C** This screw allow you to adjust the gap between doors.



CABINET INSTALLATION

1 Drill holes and insert the dowels.

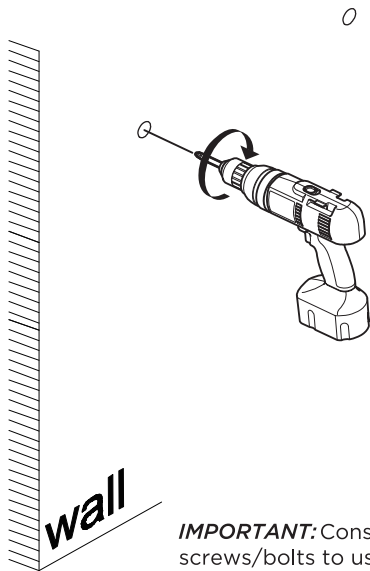

IMPORTANT: Consult an expert for the proper screws/bolts to use when attaching to various constructions. Screws provided do not attach to all wall construction types. Anchors are not required if brackets are installed in stud.

2 Mark anchor mounting hole locations on wall as shown. Drill holes in the finished wall as required.

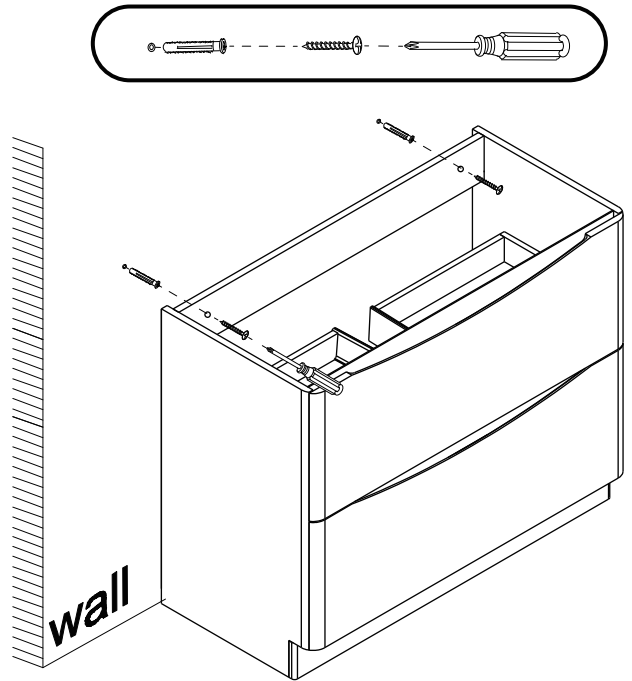

3 Apply silicone and install sink.

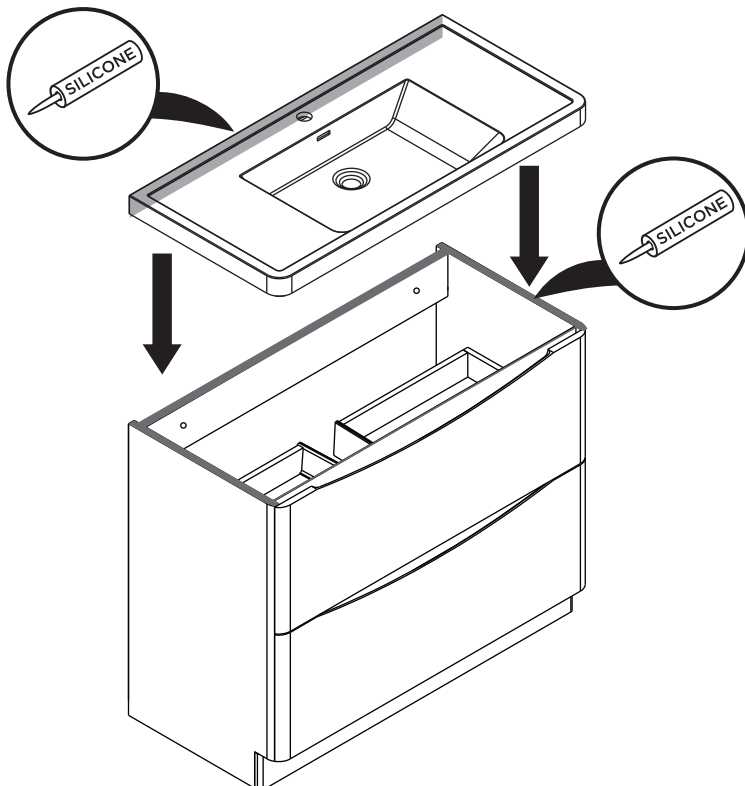

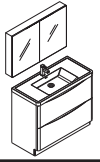

DRAWER REMOVAL & INSTALLATION

REMOVAL

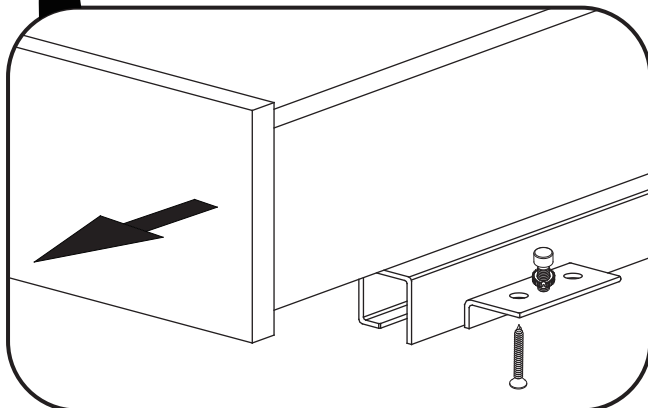
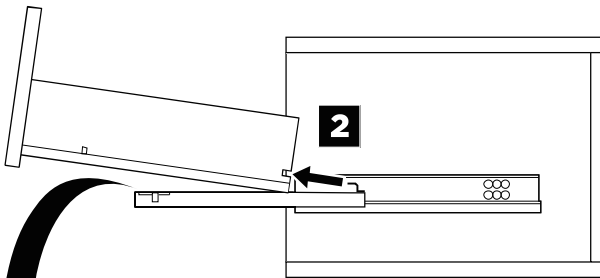
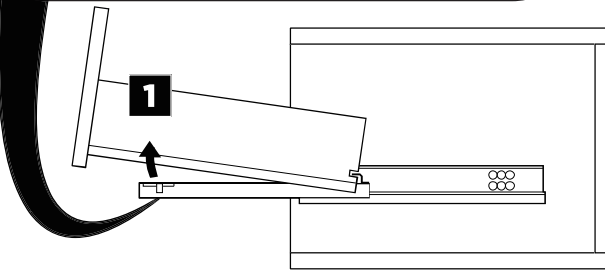
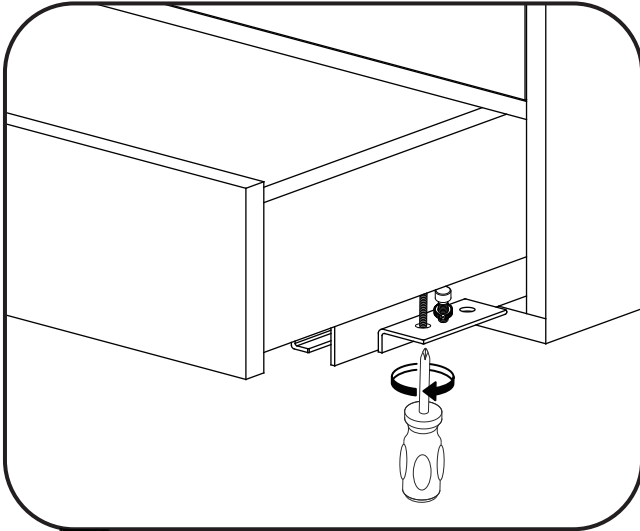

INSTALLATION

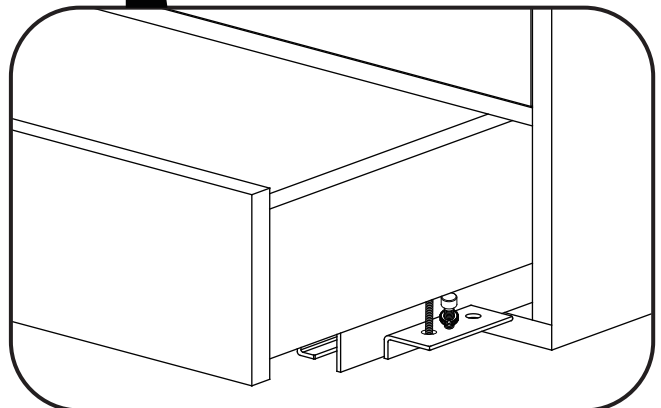
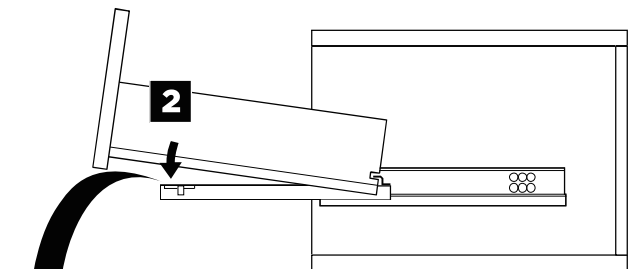
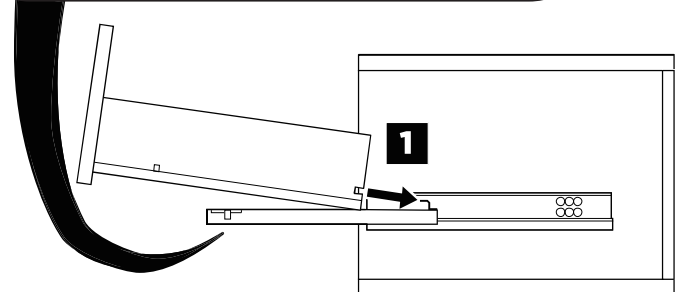
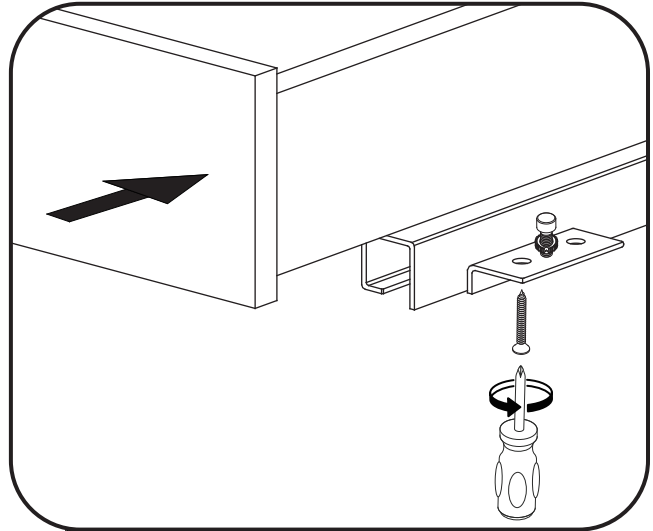

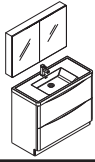

P-TRAP AND POP-UP INSTALLATION INSTRUCTIONS

NOTE:
Your item may appear slightly different from the illustration.

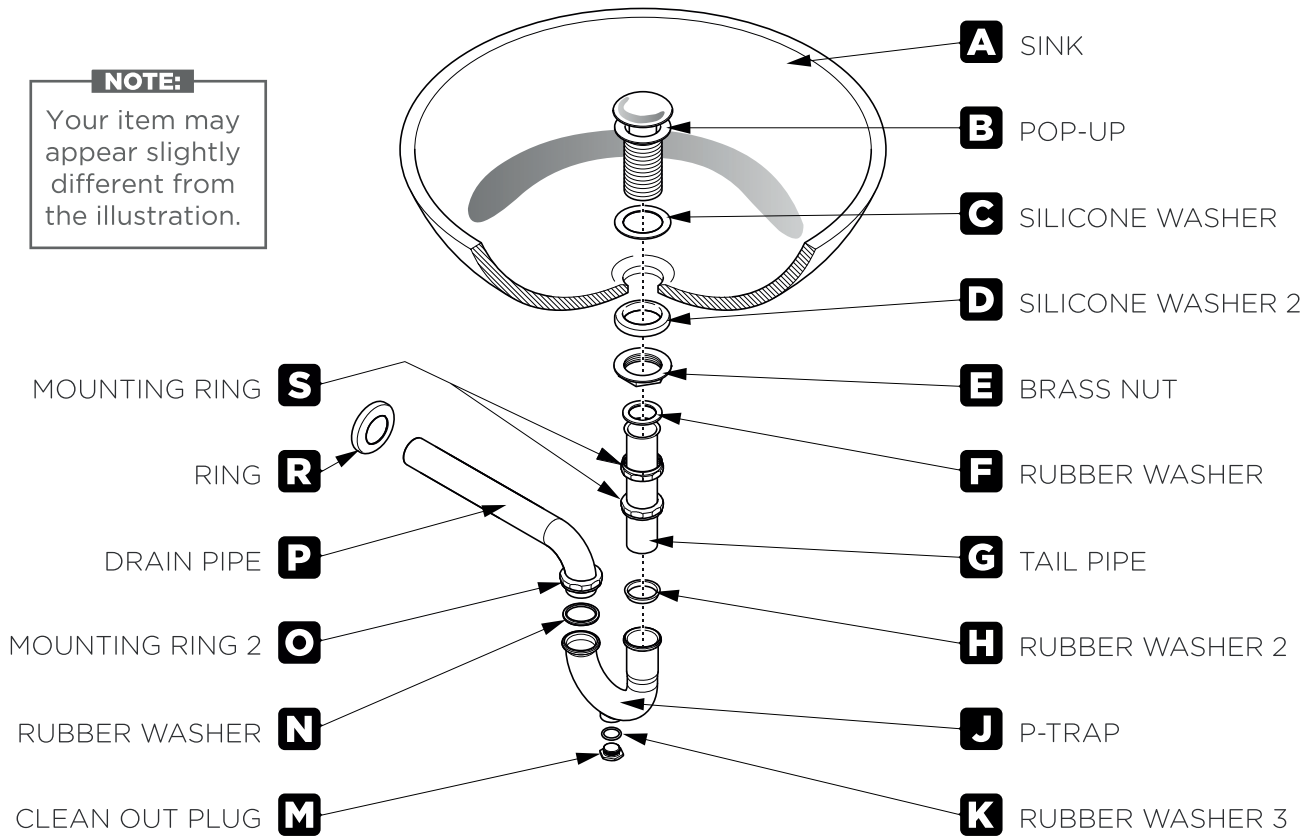

POP-UP INSTALLATION INSTRUCTIONS

FOR SINKS WITHOUT OVERFLOW

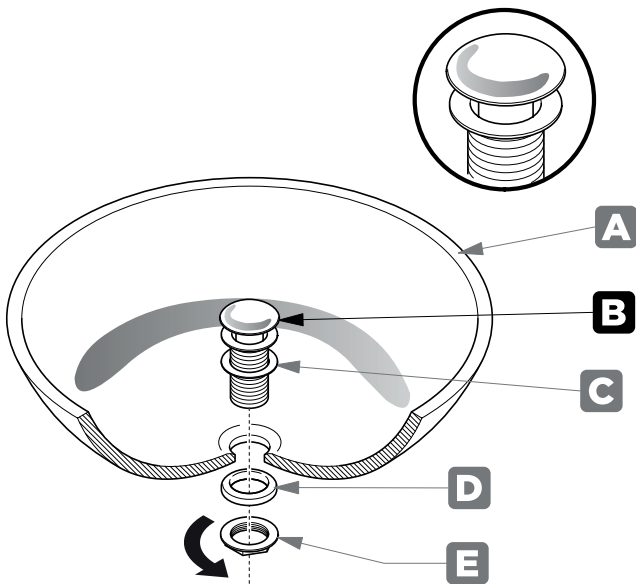

OR

FOR SINKS WITH OVERFLOW

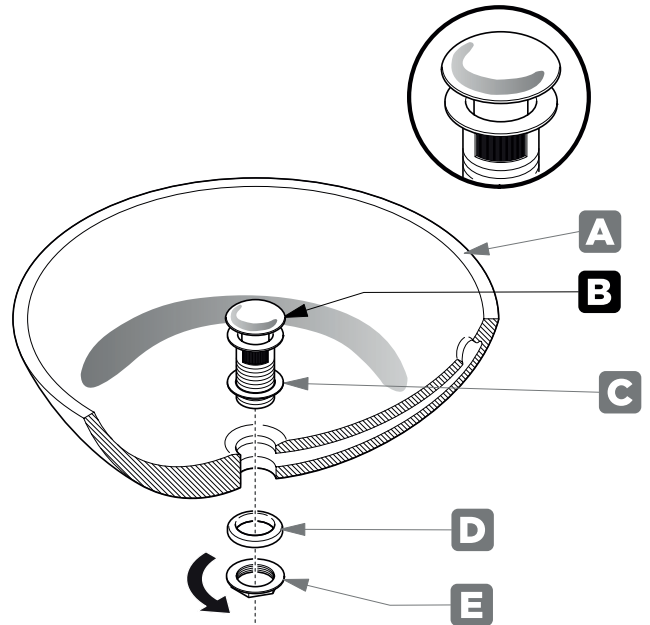

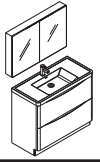

P-TRAP INSTALLATION

1 Install tail pipe (G)

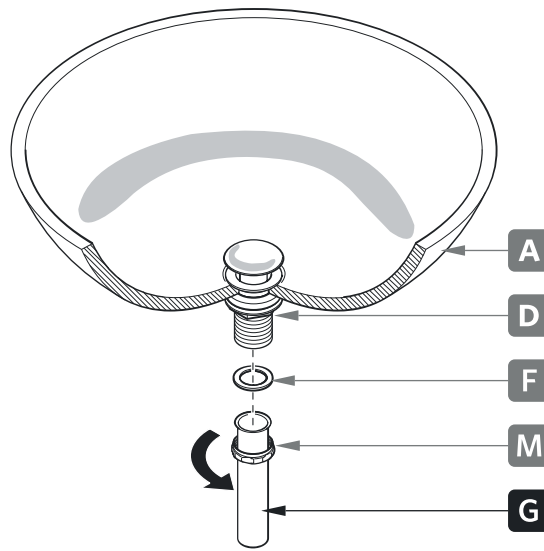

2 Install p-trap (J)

