

FVN2472
WINDSOR
 INSTALLATION GUIDE

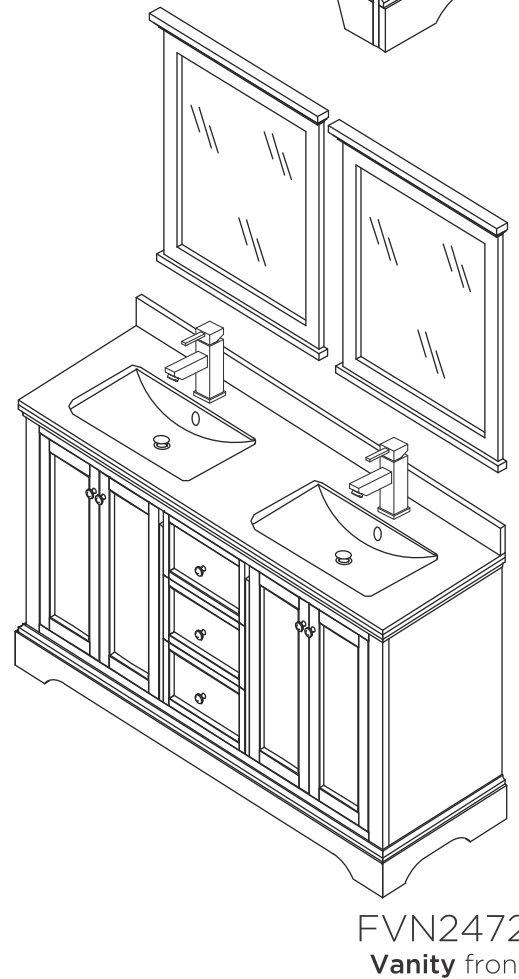

NOTE: All dimensions & specifications are approximate and subject to change without notice.

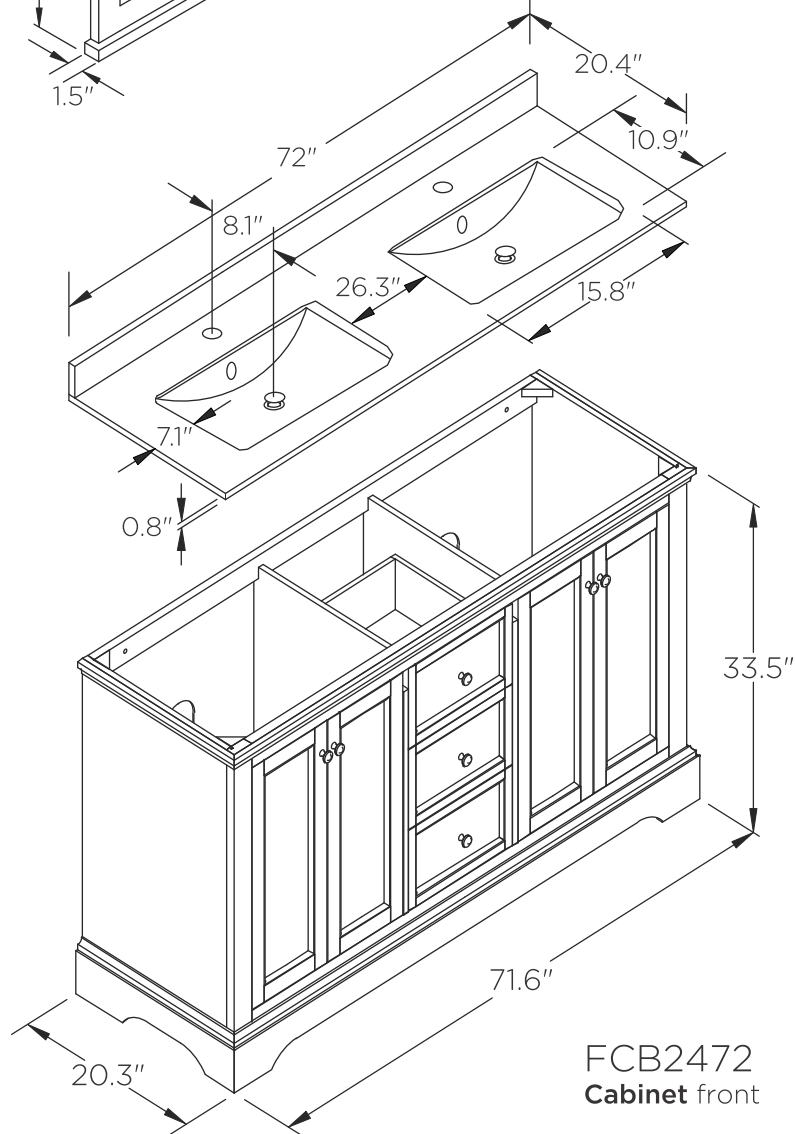
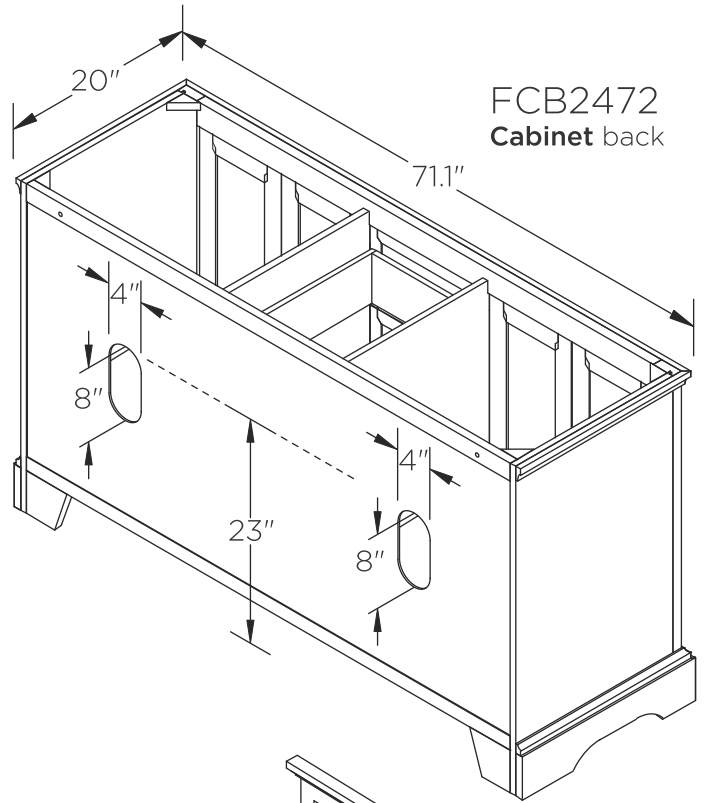
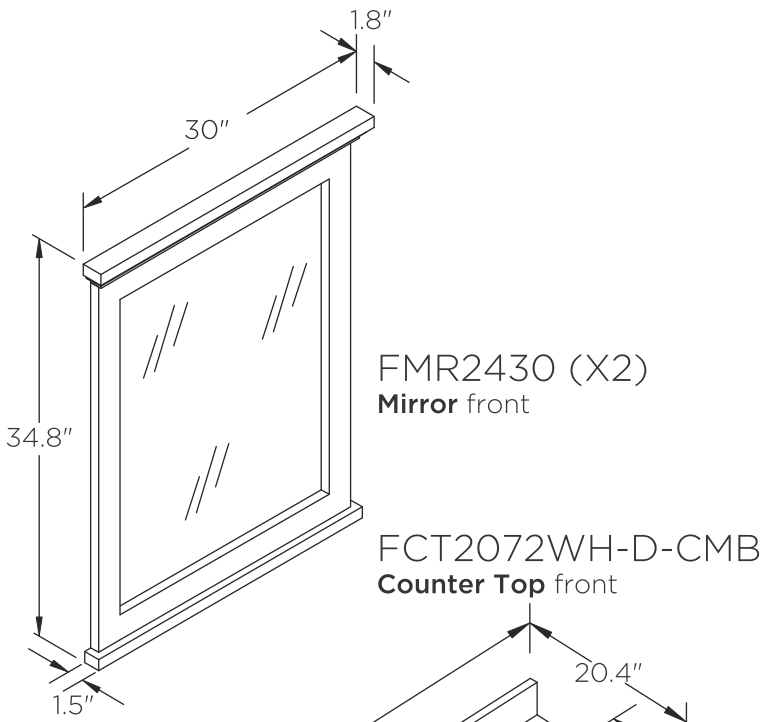

FVN2472

WINDSOR

INSTALLATION GUIDE

PAGE 1