

**FVN9032**  
**SENZA**  
**INSTALLATION GUIDE**

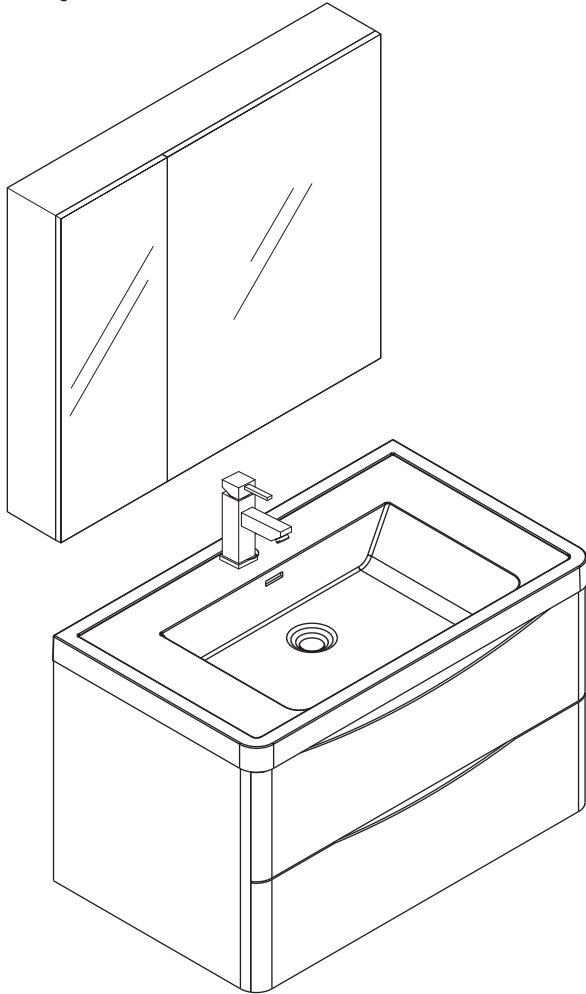

**FVN9032**  
**Vanity Front**



**FMC8090**  
**Medicine Cabinet Front**

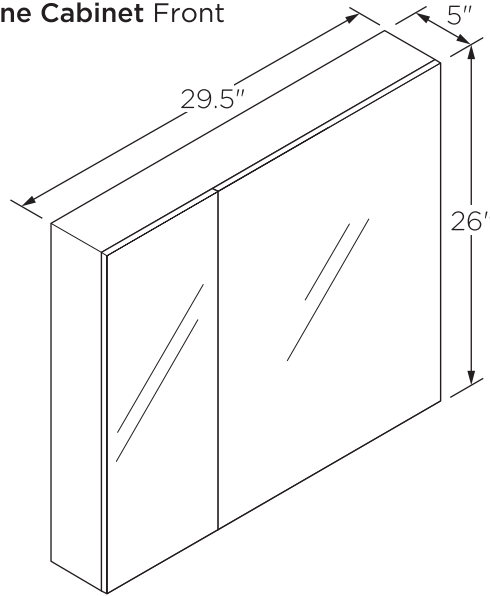

**FVS9032WH**  
**Counter Top Front**

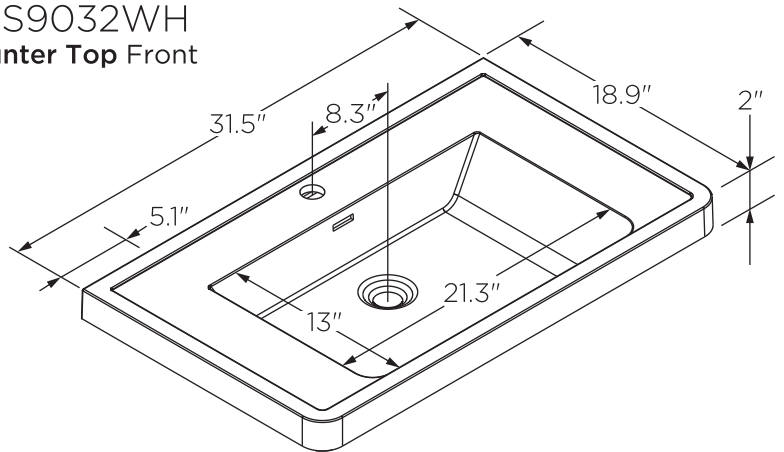

**FCB9032**  
**Cabinet Front**

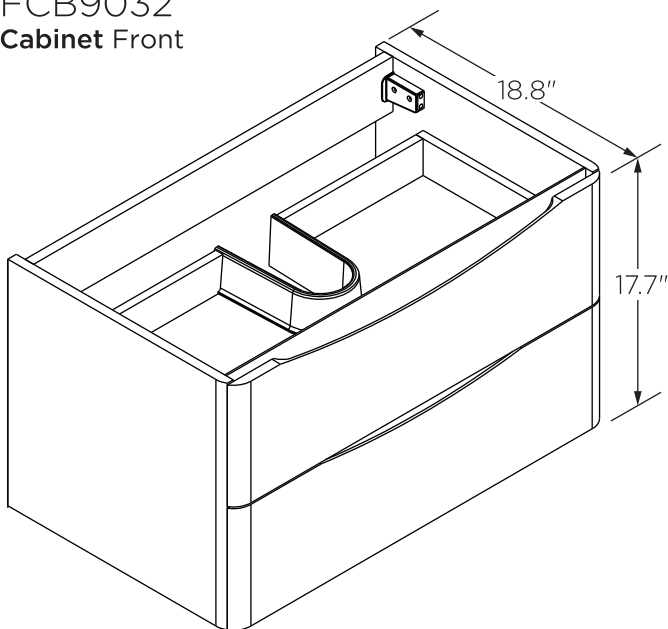

**FCB9032**  
**Cabinet Back**

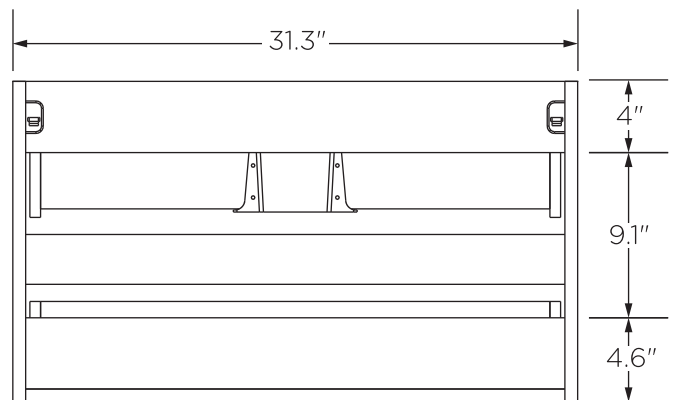

**NOTE:** All dimensions & specifications are approximate and subject to change without notice.