

# Integrated Double DishDrawer™ Dishwasher, Tall, Sanitize

series 11 | Integrated

Panel Ready



Integrates seamlessly into kitchen cabinetry. Each drawer features a premium stainless steel interior and operates independently, for flexible washing.

- Eight wash cycles from Heavy to Light, including Auto, 60min and Glassware
- Tall top drawer fits full-size dinner plates up to 12 1/4 inches, with flexible racking for large cookware
- With soft-close drawers, and knock to pause convenience

- Wi-Fi capability and a SmartHQ™ app for remote control and notifications

## DIMENSIONS

Height	34 - 36 3/8"
Width	23 9/16"
Depth	22 1/2"

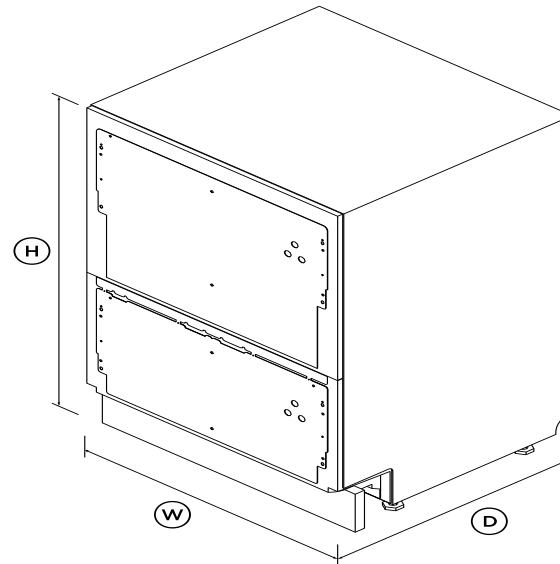

## FEATURES & BENEFITS

### SEAMLESS INTEGRATION

Install your DishDrawer™ Dishwasher into an existing kitchen space or integrate into kitchen cabinetry. The touch-sensitive control panel is located inside this Integrated model, leaving an uninterrupted exterior that blends seamlessly with surrounding cabinetry.

### EASE OF USE

DishDrawer™ Dishwashers are beautiful to use with soft-close drawers. The tall top drawer fits your larger plates and dishes up to 12 1/4 inches, while the bottom drawer is ideal for small washes. Flexible racking includes height-adjustable cup racks and wine glass supports.

### TRUE HALF LOAD

Both drawers fit a true half load. Each drawer operates independently, so you can wash one load while stacking the other drawer, or wash simultaneously on separate cycles.

### FLEXIBLE WASH OPTIONS

Eight wash programs including Auto, 60min and Glassware, while modifiers such as Sanitize, Dry+ and Quiet provide added wash flexibility. The Quiet wash modifier reduces the noise on some cycles while maintaining performance - perfect for late night washing.

### DESIGN QUALITY

Every detail has been carefully crafted using quality materials, from the easy-to-clean stainless steel interior to the spray arm sensor that detects jams for increased wash confidence.

### KNOCK TO PAUSE

For ease-of-use, these DishDrawer™ Dishwashers have a knock to pause function. A knock on the front panel will pause the dishwasher, which can be restarted by using the start button.

### QUIET PERFORMER

Running at a low decibel rating of 44dBA, these DishDrawer™ Dishwashers do their job without making a fuss. The combination of intelligent technology and simple mechanics means greater reliability and excellent wash performance.

## SPECIFICATIONS

### Accessories

Contemporary round handle

AHS-OBDD-60S

Contemporary square fine

AHD5-OBDD-60S

Contemporary square handle	<b>AHD3-OBDD-60S</b>
Cutlery basket	•
Kickstrip	•
Knife clip and multipurpose	•
Professional round flush handle	<b>AHP3-DWDD-SX</b>
Professional round handle kit	<b>AHP2-DWDD-SX</b>
Stainless steel door panel	<b>ADDD24DTPX</b>

**Capacity and loading**

Accommodates round plates	<b>12.25" (top) 11" (bottom)</b>
Adjustable height, foldable	•
Fold down tines	•
Pitch adjustable tines	•
Place settings	<b>14</b>
Wine glass supports with	•

**Consumption**

Water usage (per wash cycle)	<b>3.7 gal running both tubs</b>
------------------------------	----------------------------------

**Controls**

Child lock	•
Electronic fault/Diagnostic	•
End of cycle beeps	•
Energy saving delay start	•
Internal wash selector	•
Intuitive capacitive touch	•
Knock to pause	•
Rinse aid indicator light	•
Spray arm sensing	•
Wi-Fi connectivity	•

**Features**

Built-in water softener	•
Fan assisted drying	•
Flood protection	•
Flow through detergent	•
Internal tub material	<b>Stainless steel</b>
Quiet operation	•
SmartDrive™ technology	•
Soft close drawer	•

**Performance**

Noise on standard cycle top	<b>44dBA</b>
-----------------------------	--------------

**Power requirements**

Amperage	<b>10A</b>
Rated current	<b>15A</b>
Supply frequency	<b>60Hz</b>
Supply voltage	<b>120V</b>

**Product dimensions**

Depth	<b>22 1/2"</b>
Height	<b>34 - 36 3/8"</b>
Width	<b>23 9/16"</b>

**Warranty**

Parts and labor	<b>Limited 2 years</b>
-----------------	------------------------

**Wash Program Modifiers**

Dry +	•
-------	---

Quiet	•
Sanitize	•
Wash modifiers	<b>3</b>

**Wash Programs**

60 min	•
Auto	•
Eco	•
Glassware	•
Heavy	•
Light	•
Medium	•
Rinse	•
Wash programs	<b>8</b>

**Water connection**







Inlet water temperature	<b>max 140°F</b>
Supplied hose to suit 3/8"	•

SKU	<b>82163</b>
-----	--------------

The product dimensions and specifications in this page apply to the specific product and model. Under our policy of continuous improvement, these dimensions and specifications may change at any time. You should therefore check with Fisher & Paykel's Customer Care Centre to ensure this page correctly describes the model currently available. ? Fisher & Paykel Appliances Ltd 2020

---

Other product downloads available at [fisherpaykel.com](https://fisherpaykel.com)

-  [Energy Label Double DishDrawer](#)
-  [Wash Program Data Sheet](#)
-  [Service & Warranty](#)
-  [Wash Program Data Sheet](#)
-  [User Guide DishDrawer™](#)
-  [Data Sheet](#)
-  [Specification Guide](#)



**A PEACE OF MIND SALE**

24 Hours 7 Days a Week Customer Support

T 1.888.936.7872 W [www.fisherpaykel.com](https://www.fisherpaykel.com)