

TW206 Wall Control

SPECIFICATION and INSTRUCTION SHEET

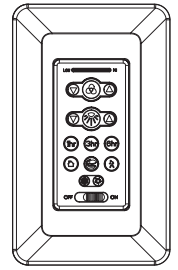

DESCRIPTION: One DC Motor Ceiling Fan and Light, Variable Speed, Reversing Remote Control

FAN MODEL USED: See Catalog or visit our website www.fanimation.com for more information

How to Wire and Operate Your TW206 Wall Control

NOTE: If fan or supply wires are different colors than indicated, have this unit installed by a qualified electrician.

⚠ WARNING

To avoid possible electrical shock, be sure electricity is turned off at the main fuse box before wiring.
NOTE: If you are not sure if the outlet box is grounded, contact a licensed electrician for advise, as it must be grounded for safe operation.

1. Installing Wall Control (Figure 1):

- With electrical power still disconnected, remove the existing wall plate and switch.
- Make wiring connections with wire nuts as shown in Figure 1.
 - One black wire from wall control unit to black (TO MOTOR L).
 - One black wire from wall control unit to black wire leading to ceiling outlet box.
 - One green wire from wall control unit to ground wire leading to ceiling outlet box.

- 2. • Attach wall control unit to outlet box using the two two screws provided.
- Attach wall plate to the switch control. (Figure 2)

• Restore electrical power.

4. Remote Control Setting and Speed (RPM) Setting Process : (Figure 3)

- 1) When powering on your fan, do not press any button(s) before pressing the “SET” button, otherwise it will fail the learn procedure. If you press a button before the “Set” button, please turn the power off then on again, and start the process again.
- 2) After installing the unit and restoring power to your fan, press and hold the “SET” button 1-5 seconds. You must press the “SET” button within 30 seconds of restoring power to the fan.
- 3) When press the “SET” button the fan will make one musical sound and start to run to begin the control setting process.
- 4) DO NOT press any button(s) after pressing the SET button and while the fan is programming or it will fail to program. The fan will run in both directions for a total of approximately 5 minutes.
- 5) When the fan stops after approximately 5 minutes the fan will make two musical sounds that mean the control and speed setting process is complete. The fan is now ready for normal use.

NOTE: If you want to change the blades: turn the power off → change the blades → turn the power on → perform the control setting process.

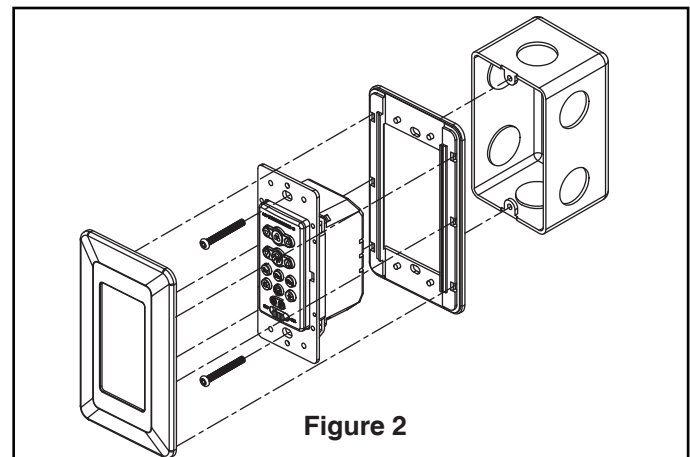
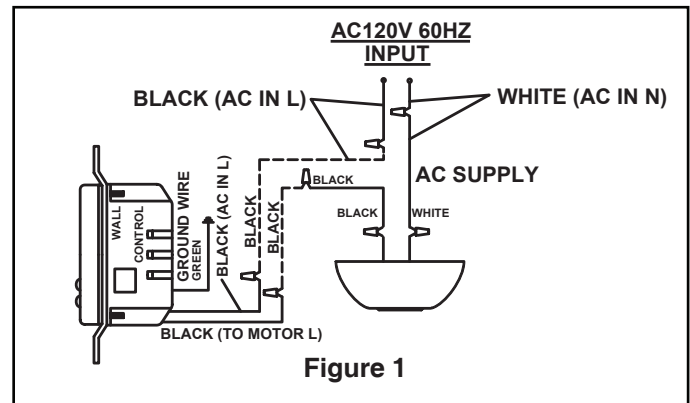





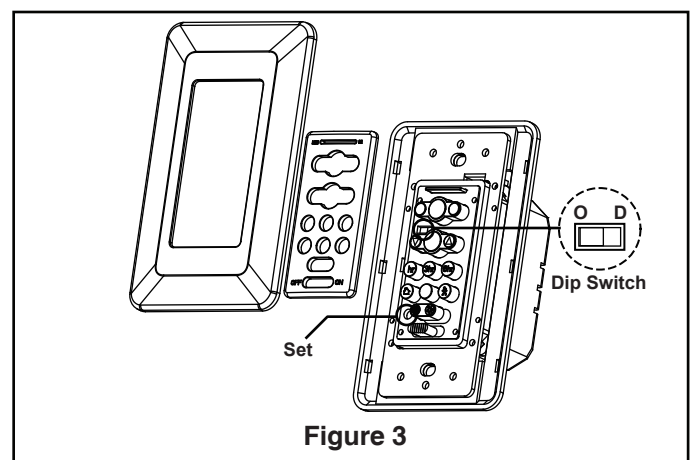









⚠ WARNING

Check to see that all connections are tight, including ground, and that no bare wire is visible at the wire connectors, except for the ground wire. Do not operate fan until the blades is in place. Noise and fan damage could result.



4. Remote functions: (Figure 4)

LOW  HI

- Indicator LED light: fan speed and light dimer indicator
-  button: Turn off the fan.
- Fan Speed:
 -  Turn on the fan and turn speed up.
 -  Turn on the fan and turn speed down.
-  Light button: Turn ON/OFF the light.
 -  Increase light output level.
 -  Decrease light output level.
- Sleep Timer:
 -  The fan and light will turn off after 1 hour.
 -  The fan and light will turn off after 3 hours.
 -  The fan and light will turn off after 6 hours.
-  Home shield: Tap this button, the fan will turn off and the light will randomly turn on and off while you are away.
-  Natural breeze: Fan speed will modulate to simulate a natural breeze.
-  Walk away light delay: Tap once-the light will turn off after 1 minute.
-  Reverse button:
 -  Summer- The fan runs counterclockwise. Airflow will provide a downward cooling breeze.
 -  Winter- The fan runs clockwise. Airflow will force warm air downward without a noticeable breeze.

5. "D" and "O" dip switch:

For this fan, switch should be in the "D" position, allowing for dimming of the light. (Figure 5)

The receiver provides the following protective function:
 Lock position: The DC motor has a built-in safety feature against blade obstruction during operation. If something obstructs the fan blades the motor will stop operating after 60 seconds of interruption. Please remove obstacles and reset.

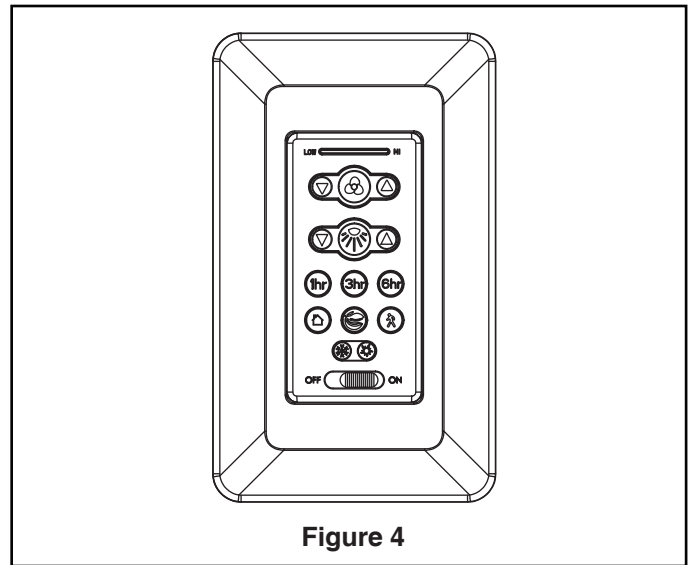

Figure 4

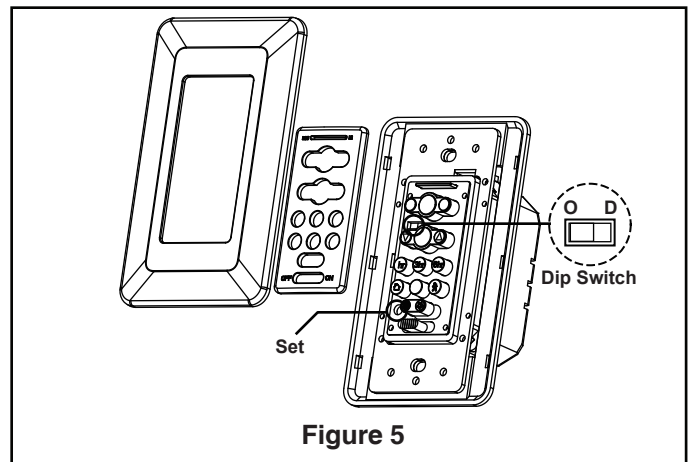

Figure 5



10983 Bennett Parkway
 Zionsville, IN 46077
 (888) 567-2055 • FAX (866) 482-5215
 Outside U.S. call (317) 733-4113
 Visit Our Website @ www.fanimation.com