



 **FANIMATION**[®]
SHOWROOM COLLECTION



FANIMATION : AIR APPARENT

Fanimation's focus is producing creative and functional fans that provide ultimate personal comfort using the latest technology for energy efficiency and seamless control. From our humble beginnings in 1984, inside Founder and CEO Tom Frampton's Pasadena, California garage, ingenuity and quality craftsmanship have been central in every product we manufacture. Our timeless and inspired fans are sought across the globe.

You will find Fanimation in some of the most luxurious locales—from tropical resorts to the heart of your home.

CHOOSING YOUR FAN

LOCATION IS EVERYTHING

Where you will install your fan is the first step in selecting the right fan for your space.

- Dry, indoor location: Choose from any of our fans—dry, damp or wet rated.
- Outdoor covered or high-humidity indoor location: Choose from our damp or wet rated fans.
- Outdoor location with likely direct contact with water: Choose from our wet rated fans.

We've made it easy for you!
Look for these icons to identify location rating:



SIZE MATTERS

The size of your room can help determine the size of your fan, identified by blade sweep. The following are general guidelines.

- **Scale is a personal preference. Large diameter fans can go in both small rooms and larger rooms—it's all in the look you desire.**
- Optimal performance will come from mounting your fan in the center of the room.
- If you have a long or large room, consider the use of multiple fans

SMALL ROOM
52 in. or smaller

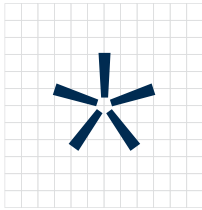

LARGE ROOM
52 in. or larger

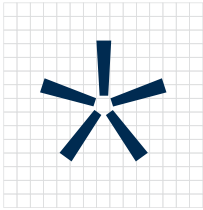

GREAT ROOM
60 in. or larger

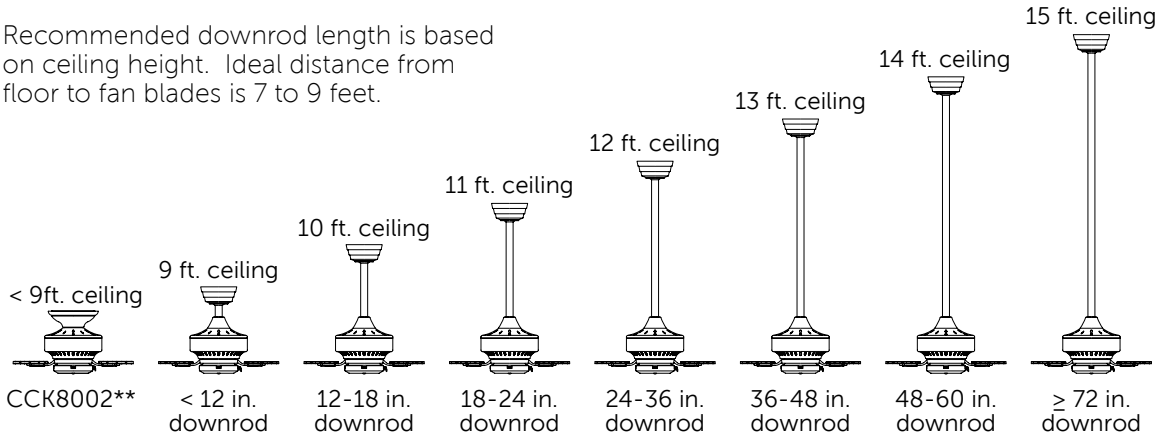
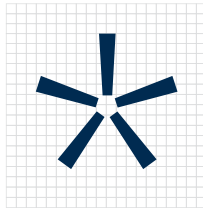



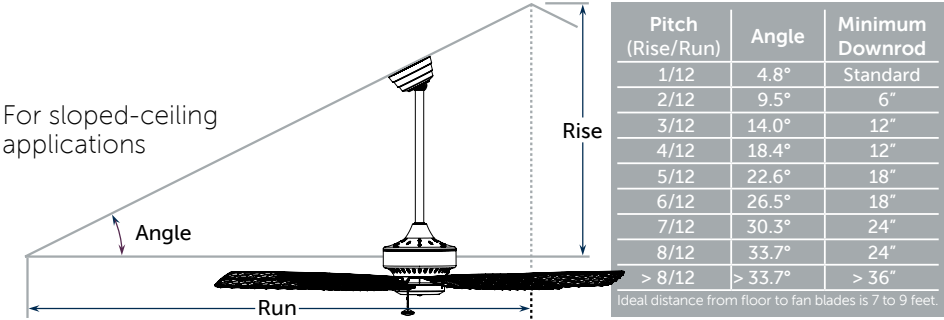

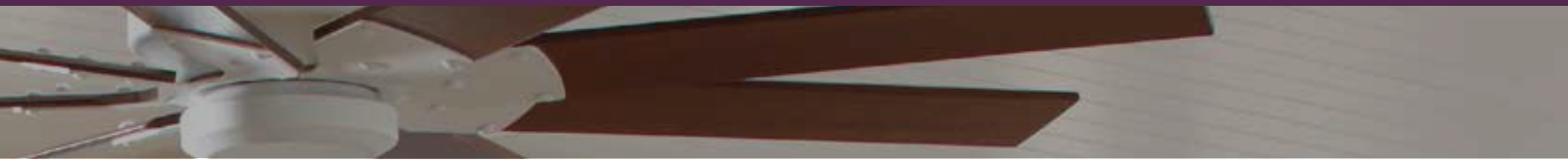





For lengths greater than 72 in., join two downrods with DR1-CP** coupler





IDENTIFYING FEATURES IMPORTANT TO YOU

We offer a diverse line of fans with equally diverse features. As you choose your fan, identify the features that matter to you—use Features Legend below to understand the Features icons.

fan control type				light kit included + lamping info	number of fan speeds + location of reversing switch	Bluetooth® control—if included or compatible	fan, blades and light sold separately	features energy-efficient DC motor	fan has earned the Energy Star
									
CONTROL wall	CONTROL remote	CONTROL pull chain	CONTROL rotary	WATTAGE bulb style	SPEED reverse location	FANSYNC™			

UNDERSTANDING AIRFLOW

We provide airflow information—at high speed—for each fan. Airflow is measured in CFM (cubic feet per minute), energy used is measured in watts and the energy efficiency of the fan is measured in CFM per watt.

ENERGY INFORMATION AT HIGH SPEED:

Airflow	Electricity Use	Airflow Efficiency
6942	65	107
Cubic Feet Per Minute	Watts (excluding lights)	Cubic Feet Per Minute Per Watt
The greater the number, the greater the air moved	Energy consumed	The greater the number, the more efficient the fan is

FANIMATION MOTORS—AC AND DC

All Fanimation motors are built using high quality materials and components, insuring years of reliable and dependable operation for every Fanimation fan.

- Our fans are equipped with either an AC motor or DC motor.
- AC motors use supplied power directly and regulate speeds by controlling frequency.
- DC motors convert supplied power and regulate speeds by controlling electrical current.
- Our AC motors come in 1-, 3- and 4-speed variants.
- Our DC motors come in 6- and 31-speed variants. DC motors are more efficient, generate more torque and are virtually silent.

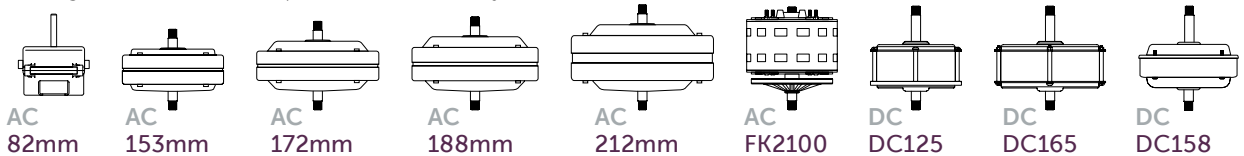

SEASONAL CEILING FAN USE

Ceiling fans save money year-round when turning in the proper direction.

WARM WEATHER
Airflow with counter-clockwise rotation, as you look up, provides a cooling breeze

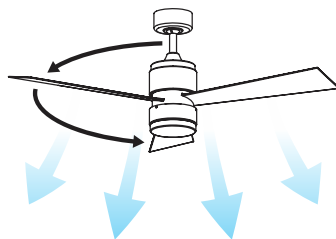

COOL WEATHER
Airflow with clockwise rotation, as you look up, forces warm air downward

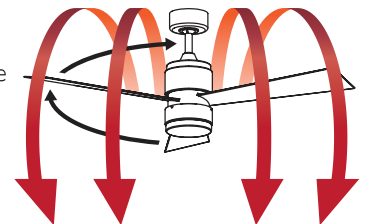

Need more assistance? Call 1-888-567-2055

INDOOR

AIRE DÉCOR
106



AIRE DELUXE 44
36



AIRE DELUXE 52
38



BECKWITH
18



BENITO
28



BOURBON
STREET
47



CAMHAVEN
30



CANCUN 42
34

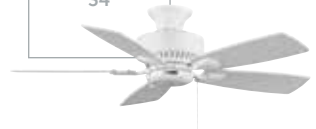

CELANO v2
22



DUPLEX
16



EDGEWOOD
DECORATIVE
40



EDGEWOOD
DELUXE
42



EDGEWOOD
SUPREME
44



EMBRACE 44
12



EMBRACE 52
14



KELLAN
46



LEVON AC
24



PALMETTO
48



STAFFORD
26



VENTANA
32



ZONIX
20



INDOOR/OUTDOOR

AIRE DÉCOR
DAMP
106



ASCENSION
68



AVASTON
96



BELLERIA
116



BIG ISLAND
126



BREWMASTER
134



CANCUN WET
118

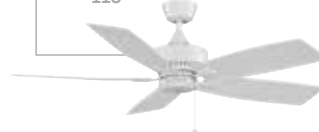

CARUSO
130



CRESTFORD
104



DRONE
56



EDGEWOOD
DELUXE WET
110



EDGEWOOD
WET
108



ENIGMA
90



EXTRAORDINAIRE
66



HUGH 44
52



HUGH 52
54



ISLANDER AC
122



ISLANDER DC
124



KAYA
102

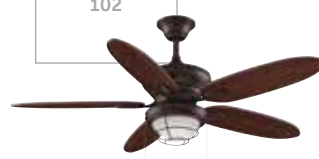

LEVON
CUSTOM
84



LEVON DC
82



My FANIMATION
DISTINCTION AC
58



My FANIMATION
DISTINCTION DC
64



ODYN
86



PALISADE
128

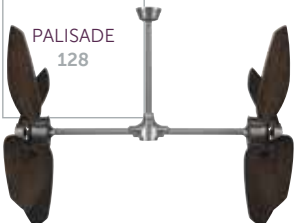

PALMA
120



PICKETT
98



PICKETT DRUM
100





INDOOR/OUTDOOR

PUNKAH
132



SPITFIRE
78



STELLAR
88



SUBTLE
80



TORTO
92



TORTO LED
94



WINDPOINTE
112



WINDPOINTE
CUSTOM
114



XENO DAMP
70



XENO WET
72



ZONIX WET
74



ZONIX LED
76



PORTABLES

ARDEN
142



MINI BREEZE
138



OLD HAVANA
144



URBANJET
140



ACCESSORIES

BLADES
157



CONTROLS
145



LIGHTING
153



DOWNRODS &
ACCESSORIES
155



TABLE OF CONTENTS

Aire Décor®	106	myFanimation™ Distinction™ AC.....	58
Aire Deluxe™ 44.....	36	myFanimation™ Distinction™ DC.....	64
Aire Deluxe™ 52.....	38	Odyn™	86
Arden™	142	Old Havana®	144
Ascension™	68	Palisade®	128
Avaston™	96	Palma™	120
Beckwith™	18	Palmetto®	48
Belleria®	116	Pickett™	98
Benito™	28	Pickett™ Drum.....	100
Big Island™	126	Punkah®	132
Bourbon Street®	47	Spitfire™	78
Brewmaster®	134	Stafford™	26
Camhaven™	30	Stellar™	88
Cancun™ 42.....	34	Subtle™	80
Cancun™ Wet.....	118	Torto™	92
Caruso™	130	Torto™ LED.....	94
Celano v2™	22	Urbanjet™	138
Crestford™	104	Ventana™	32
Drone™	56	Windpointe®	112
Duplex™	16	Windpointe® Custom	114
Edgewood® Decorative	40	Xeno™ Damp.....	70
Edgewood® Deluxe.....	42	Xeno™ Wet.....	72
Edgewood® Deluxe Wet.....	110	Zonix™	20
Edgewood® Supreme.....	44	Zonix™ LED	76
Edgewood® Wet	108	Zonix™ Wet	74
Embrace™ 44	12	Choosing a Fan	3
Embrace™ 52.....	14	Remote Controls.....	145
Enigma®	90	Wall Controls.....	147
Extraordinaire®	66	Remote Control Specifications	149
Hugh™ 44.....	52	Wall Control Specifications	150
Hugh™ 52	54	fanSync	151
Islander® AC.....	122	Bulb Reference	152
Islander® DC	124	Light Kits	153
Kaya™	102	Fitters, Shades & Decorative Glass.....	154
Kellan™	46	Downrods & Accessories	155
Levon™ AC	24	Blades.....	157
Levon™ Custom.....	84	Antique Fan Museum	159
Levon™ DC.....	82	Index.....	161
Mini Breeze™	138		





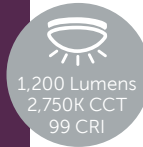
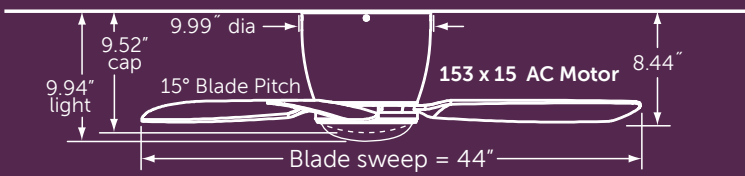

INDOOR



Net Hanging Weight: 18.9 lbs.

- 
FAN: FPS7981BN (1)
 brushed nickel assembly with
 brushed nickel blades and
 matching light cover (included)



- 
FAN: FPS7981DZ (1)
 dark bronze assembly with
 dark bronze blades and
 opal frosted glass



- 
FAN: FPS7981GR (1)
 matte greige assembly with
 matte greige blades and
 matching light cover (included)



- 
FAN: FPS7981MW (1)
 matte white assembly with
 matte white blades and
 opal frosted glass



For compatible
controls & accessories







see pages 145 to 148





EMBRACE™ 44

FAN: FPS7981GR (1)
matte greige assembly
with matte greige blades
and opal frosted glass

brushed nickel	dark bronze	matte greige	matte white
brushed nickel	dark bronze	matte greige	matte white
FPS7981BN	FPS7981DZ	FPS7981GR	FPS7981MW

-  (1) 100W halogen minican
-  3-SPEED AC reverse switch on remote
-  CONTROL remote
-  DRY indoor only

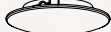
INCLUDED:

-  blade set
-  light kit
-  light cover
-  TR20WH remote

ENERGY INFORMATION AT HIGH SPEED:

Airflow	Electricity Use	Airflow Efficiency
3,855	45	87
Cubic Feet Per Minute	Watts (excluding lights)	Cubic Feet Per Minute Per Watt

LIMITED LIFETIME MOTOR WARRANTY



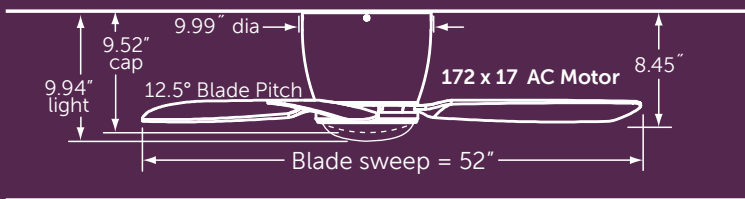

Net Hanging Weight: 21.5 lbs.

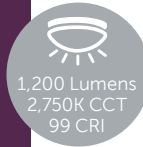

FAN: FPS7955BN (1)
brushed nickel assembly with
brushed nickel blades and
matching light cover (included)



FAN: FPS7955DZ (1)
dark bronze assembly with
dark bronze blades and
opal frosted glass



FAN: FPS7955GR (1)
matte greige assembly with
matte greige blades and
matching light cover (included)



FAN: FPS7955MW (1)
matte white assembly with
matte white blades and
opal frosted glass



For compatible
controls & accessories



see pages 145 to 148

EMBRACE™ 52

FAN: FPS7955DZ (1)
dark bronze assembly with
dark bronze blades and
opal frosted glass

brushed nickel	dark bronze	matte greige	matte white
brushed nickel	dark bronze	matte greige	matte white
FPS7955BN	FPS7955DZ	FPS7955GR	FPS7955MW



(1) 100W
halogen
minican



3-SPEED AC
reverse switch
on remote



CONTROL
remote



DRY
indoor only

INCLUDED:



blade set



light kit



light cover



TR20WH remote

ENERGY INFORMATION AT HIGH SPEED:

Airflow
5,509
Cubic Feet
Per Minute

Electricity Use
48
Watts
(excluding lights)

Airflow Efficiency
114
Cubic Feet Per
Minute Per Watt

LIMITED LIFETIME MOTOR WARRANTY



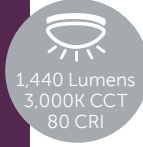
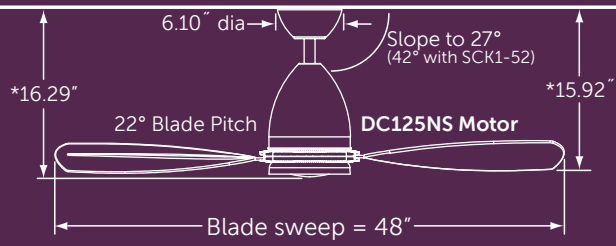

1,440 Lumens
3,000K CCT
80 CRI

*With included 6" downrod—longer lengths available

Net Hanging Weight: 16.06 lbs.



FAN: FPD6254GR (1)
matte greige fan with gray tinted fan & light housing, matte greige blades and frosted glass

For compatible controls & accessories



see pages 145 to 156

DUPLEX™

FAN: FPD6254GR (1)
 matte greige fan with
 gray tinted fan & light
 housing, matte greige
 blades and frosted glass

matte gray
 greige tinted
 matte greige
FPD6254GR

ENERGY SAVINGS



**18W
 LED**

6-SPEED DC
 reverse switch
 on remote

CONTROL
 remote

DRY
 indoor only

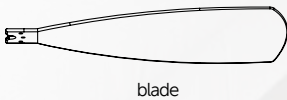
INCLUDED:



blade



light kit



TR39 remote

**ENERGY INFORMATION
 AT HIGH SPEED:**

Airflow
5,013
 Cubic Feet
 Per Minute

Electricity Use
32
 Watts
 (excluding lights)

Airflow Efficiency
155
 Cubic Feet Per
 Minute Per Watt

LIMITED LIFETIME MOTOR WARRANTY



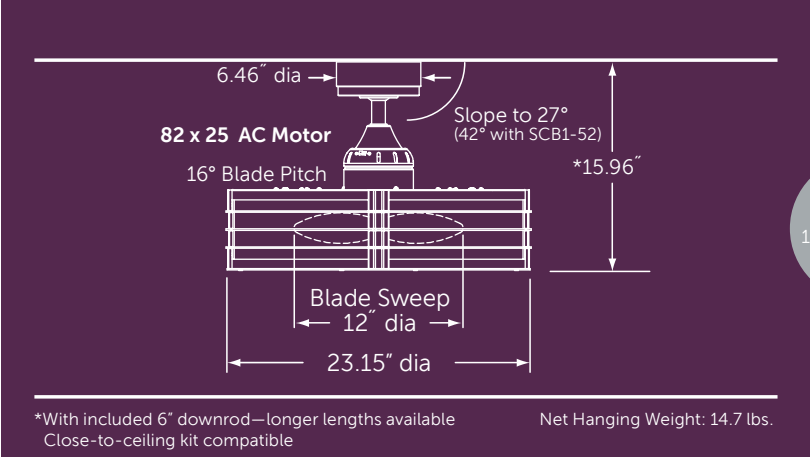

1,368 Lumens
2,478K CCT
99 CRI

NOTE: THE LIGHT ON THE BECKWITH™ IS CONSIDERED AN ACCENT LIGHT AND IS NOT INTENDED TO BE USED AS A PRIMARY LIGHT SOURCE

FAN: FP7964BN (1)
brushed nickel assembly
with frosted white shade



FAN: FP7964OB (1)
oil-rubbed bronze assembly
with frosted white shade



For compatible
controls & accessories



see pages 145 to 156

BECKWITH™



 **FAN: FP7964OB (1)**
oil-rubbed bronze assembly
with frosted white shade

brushed nickel	oil-rubbed bronze
aluminum blades	black blades
FP7964BN	FP7964OB

INCLUDED:



TR24WH remote

FANSYNC™
sold separately

(4) 43W
halogen
candelabra

3-SPEED AC
reverse switch
on fan

CONTROL
remote

DRY
indoor only

ENERGY INFORMATION AT HIGH SPEED:

Airflow
907
Cubic Feet
Per Minute

Electricity Use
55
Watts
(excluding lights)

Airflow Efficiency
17
Cubic Feet Per
Minute Per Watt

LIMITED LIFETIME MOTOR WARRANTY



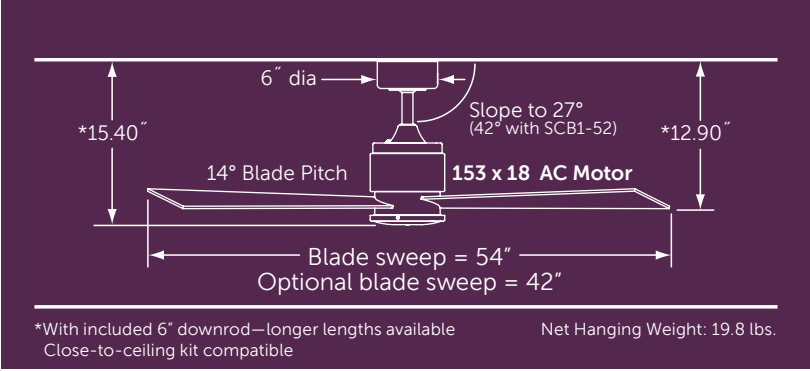

FAN: FP4620BL (1)
black assembly with
black wood blades



FAN: FP4620BN (1)
brushed nickel assembly with
reversible cherry/walnut wood blades
● cherry side showing



FAN: FP4620OB (1)
oil-rubbed bronze assembly with
reversible cherry/walnut wood blades
● cherry side showing



FAN: FP4620PN (1)
polished nickel assembly with
reversible cherry/walnut wood blades
● walnut side showing



FAN: FP4620SN (1)
satin nickel assembly with reversible
cherry/walnut wood blades
● cherry side showing



FAN: FP4630SN (1)
satin nickel assembly with
satin nickel wood blades



For compatible
controls & accessories





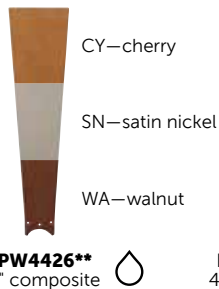
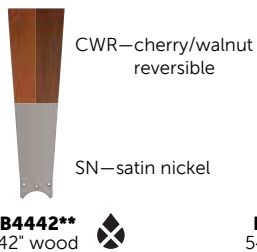

see pages 145 to 156



ZONIX™

 **FAN: FP4620BL (1)**
black assembly with
black wood blades

black	brushed nickel	oil-rubbed bronze	polished nickel	satin nickel	satin nickel
black	cherry walnut	cherry walnut	cherry walnut	cherry walnut	satin nickel
FP4620BL	FP4620BN	FP4620OB	FP4620PN	FP4620SN	FP4630SN

-  **FANSYNC™**
sold separately
-  **4-SPEED AC**
reverse switch
on fan
-  **CONTROL**
wall
-  **DRY**
indoor only

INCLUDED:

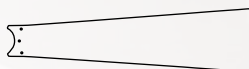

blade set



CW40 wall control

**ENERGY INFORMATION
AT HIGH SPEED:**

Airflow	Electricity Use	Airflow Efficiency
4,436	57	78
Cubic Feet Per Minute	Watts (excluding lights)	Cubic Feet Per Minute Per Watt

LIMITED LIFETIME MOTOR WARRANTY



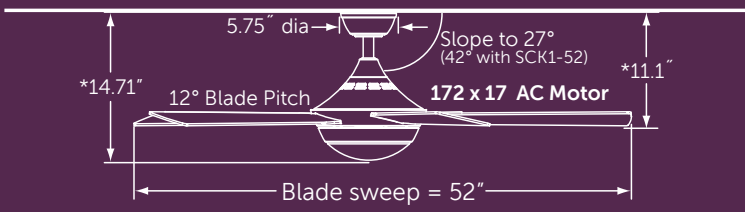



 1,350 Lumens
 3,000K CCT
 80 CRI

*With included 4.5" downrod—longer lengths available Net Hanging Weight: 18.74 lbs.



 **FAN: FP8062BN** (1)
 brushed nickel assembly with
 frosted white glass and reversible
 cherry/dark walnut blades

- cherry side showing



 **FAN: FP8062DZ** (1)
 dark bronze assembly with
 frosted glass and reversible
 cherry/dark walnut blades

- dark walnut side showing



 **FAN: FP8062MW** (1)
 matte white assembly
 with frosted glass and
 matte white blades



For compatible
controls & accessories



see pages 145 to 156

CELANO v2™



FAN: FP8062BN (1)
brushed nickel assembly
with cherry/dark walnut
reversible blades.
● dark walnut side showing

brushed nickel	dark bronze	matte white
cherry dark walnut	cherry dark walnut	matte white
FP8062BN	FP8062DZ	FP8062MW

- FANSYNC™** included
- 18W LED**
- 3-SPEED AC** reverse switch on fan
- CONTROL** remote
- DRY** indoor only

INCLUDED:

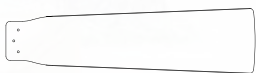

blade set



light kit



BTT9

ENERGY INFORMATION AT HIGH SPEED:

Airflow	Electricity Use	Airflow Efficiency
5,596	60	93
Cubic Feet Per Minute	Watts (excluding lights)	Cubic Feet Per Minute Per Watt



LIMITED LIFETIME MOTOR WARRANTY



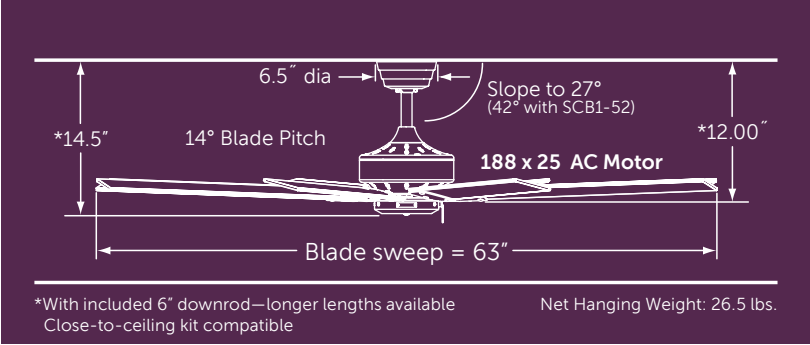

FAN: FP7910BL (1)
black assembly with black blades



FAN: FP7910BN (1)
brushed nickel assembly
with reversible cherry/walnut
wood blades
● walnut side showing



FAN: FP7910MW (1)
matte white assembly with
matte white blades



FAN: FP7910OB (1)
oil-rubbed bronze assembly
with walnut blades



For compatible
controls & accessories



see pages 145 to 156

LEVON™ AC



FAN: FP7910BN (1)
brushed nickel assembly
with reversible cherry/
walnut wood blades
● walnut side showing

brushed nickel	black	matte white	oil-rubbed bronze
cherry walnut	black	matte white	walnut
FP7910BN	FP7910BL	FP7910MW	FP7910OB

- FANSYNC™**
sold separately
- 3-SPEED AC**
reverse switch
on fan
- CONTROL**
pull chain
- DRY**
indoor only

INCLUDED:

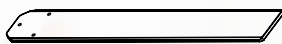

blade set

ENERGY INFORMATION AT HIGH SPEED:

Airflow	Electricity Use	Airflow Efficiency
6942	65	107
Cubic Feet Per Minute	Watts (excluding lights)	Cubic Feet Per Minute Per Watt



LIMITED LIFETIME MOTOR WARRANTY



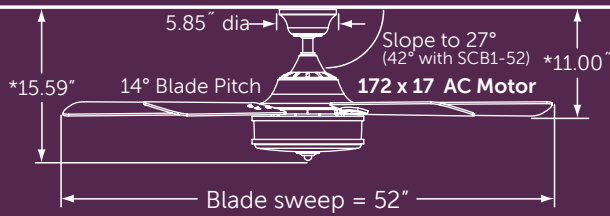



 1,020 Lumens
 2,700K CCT
 99 CRI

*With included 4.5" downrod—longer lengths available
 Close-to-ceiling kit compatible

Net Hanging Weight: 23.2 lbs.

- 
FAN: PL8274BN (1)
 brushed nickel assembly with
 frosted white glass and reversible
 cherry/dark walnut blades
 - dark walnut side showing



- 
FAN: PL8274DZ (1)
 dark bronze assembly with
 frosted white glass and reversible
 cherry/dark walnut blades
 - cherry side showing



- 
FAN: PL8274BN (1)
 brushed nickel assembly with
 frosted white glass and reversible
 cherry/dark walnut blades
 - cherry side showing



- 
FAN: PL8274DZ (1)
 dark bronze assembly with
 frosted white glass and reversible
 cherry/dark walnut blades
 - dark walnut side showing



For compatible
 controls & accessories



see pages 145 to 156

STAFFORD™

FAN: PL8274DZ(1)
 dark bronze assembly with frosted white glass and reversible cherry/dark walnut blades
 • dark walnut side showing

brushed nickel	dark bronze
cherry dark walnut	cherry dark walnut
PL8274BN	PL8274DZ

- FANSYNC™**
sold separately
- (3) 40W**
incandescent candelabra
- 3-SPEED AC**
reverse switch on fan
- CONTROL**
remote
- DRY**
indoor only

INCLUDED:





ENERGY INFORMATION AT HIGH SPEED:

Airflow	Electricity Use	Airflow Efficiency
4,911	56	88
Cubic Feet Per Minute	Watts (excluding lights)	Cubic Feet Per Minute Per Watt

LIMITED LIFETIME MOTOR WARRANTY

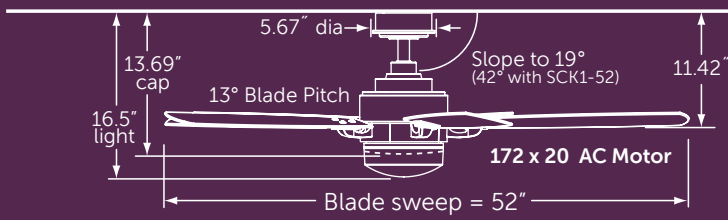





 1,600 Lumens
 2,800K CCT
 99 CRI

*With included 4.5" downrod—longer lengths available
Close-to-ceiling kit compatible

Net Hanging Weight: 19.6 lbs.

- 
FAN: FP8003BN (1)
 brushed nickel assembly with opal frosted glass and reversible cherry/walnut wood blades
 - cherry side showing



- 
FAN: FP8003MW (1)
 matte white assembly with opal frosted glass and matte white wood blades



- 
FAN: FP8003OB (1)
 oil-rubbed bronze assembly with and reversible mahogany/walnut wood blades and matching light cover (included)
 - mahogany side showing



- 
FAN: FP8003PN (1)
 polished nickel assembly with opal frosted glass and reversible cherry/walnut wood blades
 - cherry side showing



- 
FAN: FP8003SN (1)
 satin nickel assembly with opal frosted glass and reversible cherry/walnut wood blades
 - walnut side showing



For compatible controls & accessories



see pages 145 to 156

BENITO™

FAN: FP8003BN (1)
brushed nickel assembly with
opal frosted glass and reversible
cherry/walnut wood blades
• walnut side showing

brushed nickel	matte white	oil-rubbed bronze	polished nickel	satin nickel
cherry walnut	matte white	ma- hogany walnut	cherry walnut	cherry walnut
FP8003BN	FP8003MW	FP8003OB	FP8003PN	FP8003SN

FANSYNC™
sold separately

(1) 100W
halogen
minican

3-SPEED AC
reverse switch
on fan

CONTROL
remote

DRY
indoor only

INCLUDED:



blade set



light kit
light cover



TR24WH remote

**ENERGY INFORMATION
AT HIGH SPEED:**

Airflow
5,052
Cubic Feet
Per Minute

Electricity Use
63
Watts
(excluding lights)

Airflow Efficiency
80
Cubic Feet Per
Minute Per Watt



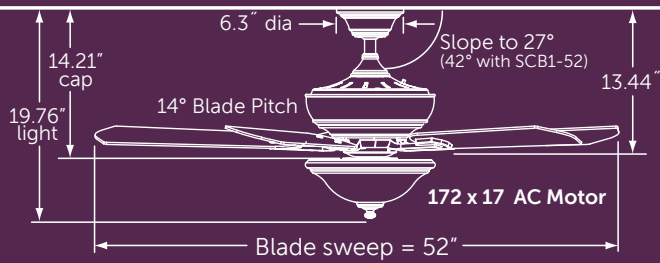

2,062 Lumens
2,756K CCT
99 CRI

*With included 4.5" downrod—longer lengths available
Close-to-ceiling kit compatible

Net Hanging Weight: 24.47 lbs.

FAN: FP8095BA (1)
bronze accent assembly with
frosted white glass and reversible
cherry/walnut wood blades
● walnut side showing



FAN: FP8095OB (1)
oil-rubbed bronze assembly (shown
without light kit) with reversible
cherry/walnut wood blades
● cherry side showing



FAN: FP8095PW (1)
pewter assembly with frosted
white glass and reversible
cherry/walnut wood blades
● walnut side showing



FAN: FP8095WH (1)
white assembly with white frosted
glass and white wood blades



For compatible
controls & accessories



see pages 145 to 156

CAMHAVEN™

FAN: FP8095PW(1)
 pewter assembly with frosted white glass and reversible cherry/walnut wood blades
 ● walnut side showing

bronze accent	oil-rubbed bronze	pewter	white
cherry walnut	cherry walnut	cherry walnut	white
FP8095BA	FP8095OB	FP8095PW	FP8095WH

FANSYNC™
 sold separately

 (2) 75W
 halogen
 minican

 3-SPEED AC
 reverse switch
 on fan

CONTROL
 remote

DRY
 indoor only

INCLUDED:



blade set



light kit



TR24WH remote

ENERGY INFORMATION AT HIGH SPEED:

Airflow
5,813
 Cubic Feet
 Per Minute

Electricity Use
67
 Watts
 (excluding lights)

Airflow Efficiency
87
 Cubic Feet Per
 Minute Per Watt

LIMITED LIFETIME MOTOR WARRANTY



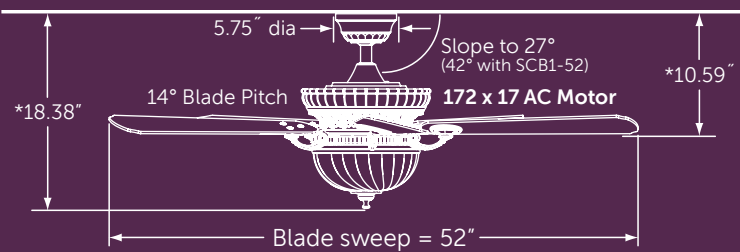



 1,092 Lumens
 2,653K CCT
 99 CRI

*With included 4.5" downrod—longer lengths available
 Close-to-ceiling kit compatible

Net Hanging Weight: 24.5 lbs.



FAN: FP8032DZ (1)
 dark bronze assembly
 with frosted white glass
 and reversible cherry/dark
 walnut blades

- cherry side showing



FAN: FP8032DZ (1)
 dark bronze assembly
 with frosted white glass
 and reversible cherry/dark
 walnut blades

- dark walnut side showing

For compatible controls & accessories



see pages 145 to 156

VENTANA™

FAN: FP8032DZ (1)
 dark bronze assembly
 with frosted white glass
 and reversible cherry/dark
 walnut blades
 • dark walnut side showing

dark
bronze
cherry dark
walnut
FP8032DZ

FANSYNC™
 sold separately

(2) 50W
 halogen
 minican

3-SPEED AC
 reverse switch
 on fan

CONTROL
 remote

DRY
 indoor only

INCLUDED:



blade set



light kit



TR24WH remote

**ENERGY INFORMATION
 AT HIGH SPEED:**

Airflow
5,792
 Cubic Feet
 Per Minute

Electricity Use
83
 Watts
 (excluding lights)

Airflow Efficiency
70
 Cubic Feet Per
 Minute Per Watt

LIMITED LIFETIME MOTOR WARRANTY



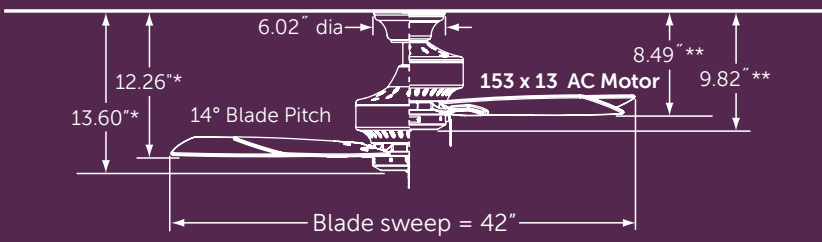

*With included 4.5" downrod—longer lengths available

Net Hanging Weight: 15.37 lbs.

**With included flush mount kit



- FAN: FP8042OB (1)**
 oil-rubbed bronze assembly in flush-mount configuration with reversible cherry/walnut wood blades
 - cherry side showing

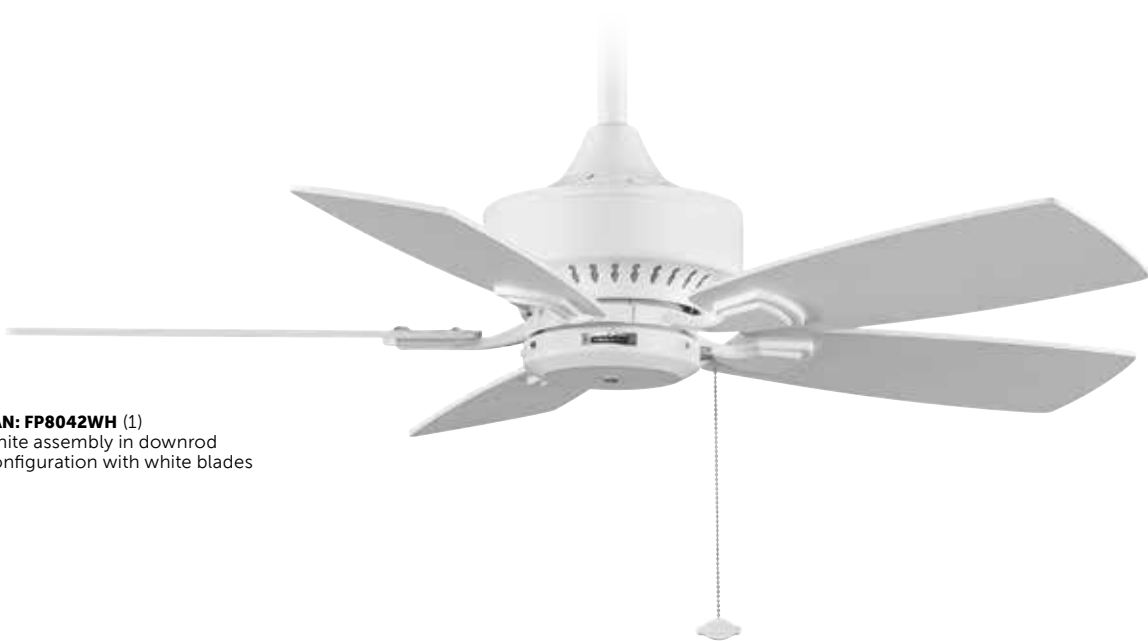

- FAN: FP8042WH (1)**
 white assembly in downrod configuration with white blades

For compatible controls & accessories



see pages 145 to 156

CANCUN™ 42

- FAN: FP8042OB (1)**
oil-rubbed bronze assembly with reversible cherry/walnut wood blades
- walnut side showing

oil-rubbed bronze	white
cherry walnut	white
FP8042OB	FP8042WH



FANSYNC™
sold separately



3-SPEED AC
reverse switch
on fan



CONTROL
pull chain



DRY
indoor only

INCLUDED:



blade set

**ENERGY INFORMATION
AT HIGH SPEED:**

Airflow
3,943
Cubic Feet
Per Minute

Electricity Use
47
Watts
(excluding lights)

Airflow Efficiency
84
Cubic Feet Per
Minute Per Watt

LIMITED LIFETIME MOTOR WARRANTY



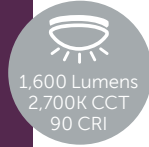
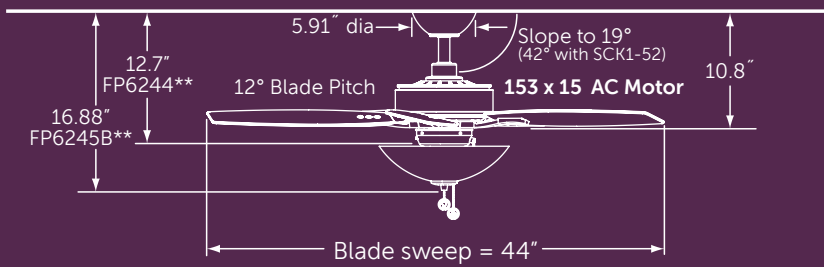

*With included 4.5" downrod—longer lengths available
Close-to-ceiling kit compatible

FP6244** Net Hanging Weight: 14.66 lbs.
FP6245B** Net Hanging Weight: 16.64 lbs.

- FAN: FP6244BN (1)**
brushed nickel assembly
with reversible cherry/dark
walnut wood blades
 - dark walnut side showing



- FAN: FP6244DZ (1)**
dark bronze assembly with reversible
cherry/dark walnut wood blades
 - cherry side showing



- FAN: FP6244MW (1)**
matte white assembly with
matte white wood blades



For compatible
controls & accessories



see pages 145 to 156

AIRE DELUXE™ 44



FAN: FP6245BBN (1)
brushed nickel assembly with white frosted glass bowl and reversible cherry/dark walnut blades

- dark walnut side showing



FAN: FP6245BDZ (1)
dark bronze assembly with white frosted glass bowl and reversible cherry/dark walnut blades

- cherry side showing



FAN: FP6245BMW (1)
matte white assembly with white frosted glass bowl and matte white blades

brushed nickel	dark bronze	matte white
cherry dark walnut	cherry dark walnut	matte white
FP6244BN FP6245BBN	FP6244DZ FP6245BDZ	FP6244MW FP6245BMW





INCLUDED:

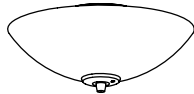

blade set



light kit—FP6245B** only

				
FANSYNC™ sold separately	(2) 10W E26 LED FP6245B** only	3-SPEED AC reverse switch on fan	CONTROL pull chain	DRY indoor only

ENERGY INFORMATION
AT HIGH SPEED:

FP6244**	Airflow 3,905	Electricity Use 53	Airflow Efficiency 74
FP6245B**	3,937	53	75
	Cubic Feet Per Minute	Watts (excluding lights)	Cubic Feet Per Minute Per Watt

LIMITED LIFETIME MOTOR WARRANTY



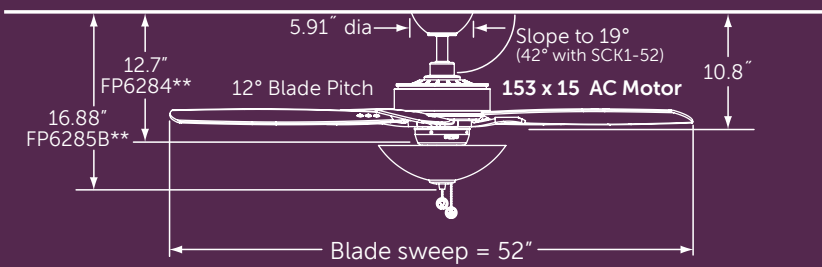



 1,600 Lumens
 2,700K CCT
 90 CRI

*With included 4.5" downrod—longer lengths available
 Close-to-ceiling kit compatible

FP6284** Net Hanging Weight: 15.36 lbs.
 FP6285B** Net Hanging Weight: 17.34 lbs.



 **FAN: FP6284BN** (1)
 brushed nickel assembly
 with reversible cherry/dark
 walnut wood blades

- dark walnut side showing



 **FAN: FP6284DZ** (1)
 dark bronze assembly with reversible
 cherry/dark walnut wood blades

- cherry side showing



 **FAN: FP6284MW** (1)
 matte white assembly with
 matte white wood blades



For compatible
 controls & accessories



see pages 145 to 156

AIRE DELUXE™ 52



FAN: FP6285BBN (1)
brushed nickel assembly with white frosted glass bowl and reversible cherry/dark walnut blades

- dark walnut side showing



FAN: FP6285BDZ (1)
dark bronze assembly with white frosted glass bowl and reversible cherry/dark walnut blades

- cherry side showing



FAN: FP6285BMW (1)
matte white assembly with white frosted glass bowl and matte white blades



brushed nickel	dark bronze	matte white
cherry dark walnut	cherry dark walnut	matte white
FP6284BN FP6285BBN	FP6284DZ FP6285BDZ	FP6284MW FP6285BMW

INCLUDED:



blade set

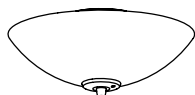

light kit—FP6285B** only

FANSYNC™ sold separately	(2) 10W E26 LED FP6285B** only	3-SPEED AC reverse switch on fan	CONTROL pull chain	DRY indoor only

ENERGY INFORMATION AT HIGH SPEED:

Airflow	Electricity Use	Airflow Efficiency
FP6284** 5,284	54	97
FP6285B** 5,279	54	97
Cubic Feet Per Minute	Watts (excluding lights)	Cubic Feet Per Minute Per Watt



LIMITED LIFETIME MOTOR WARRANTY



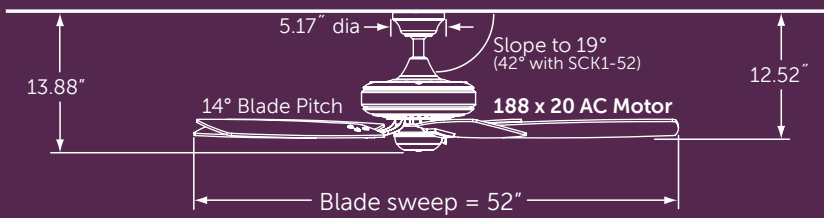

*With included 4.5" downrod—longer lengths available
Close-to-ceiling kit compatible

Net Hanging Weight: 21.19 lbs.



- FAN: TF610OB (1)**
oil-rubbed bronze assembly with reversible cherry/walnut wood blades
 - walnut side showing



- FAN: TF610SN (1)**
satin nickel assembly with reversible walnut/light walnut wood blades
 - walnut side showing



- FAN: TF610WH (1)**
white assembly with reversible white/white oak wood blades
 - white side showing



For compatible controls & accessories



see pages 145 to 156



reversible walnut/
light walnut

BEW42WALW
42" wood

EDGEWOOD® DECORATIVE



FAN: TF610SN (1)
oil-rubbed bronze assembly with reversible cherry/walnut wood blades
• walnut side showing

oil-rubbed bronze	satin nickel	white
cherry walnut	walnut light walnut	white white oak
TF610OB	TF610SN	TF610WH

FANSYNC™
sold separately

3-SPEED AC
reverse switch on fan

CONTROL
pull chain

DRY
indoor only

INCLUDED:



blade set

ENERGY INFORMATION
AT HIGH SPEED:

Airflow
7,057
Cubic Feet
Per Minute

Electricity Use
80
Watts
(excluding lights)

Airflow Efficiency
89
Cubic Feet Per
Minute Per Watt



LIMITED LIFETIME MOTOR WARRANTY



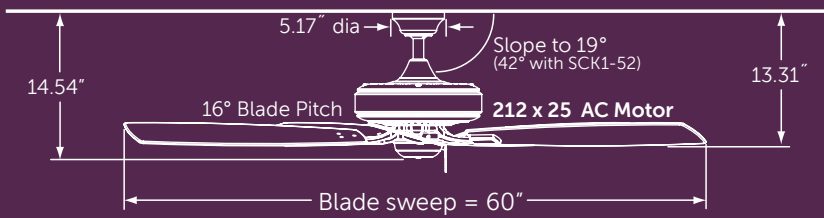

*With included 4.5" downrod—longer lengths available
Close-to-ceiling kit compatible

Net Hanging Weight: 29.78 lbs.



- FAN: TF710OB (1)**
oil-rubbed bronze assembly with reversible cherry/walnut wood blades
 - walnut side showing



- FAN: TF710SN (1)**
satin nickel assembly with reversible walnut/light walnut wood blades
 - light walnut side showing



- FAN: TF710WH (1)**
white assembly with reversible white/white oak wood blades
 - white oak side showing



For compatible controls & accessories



see pages 145 to 156



reversible walnut/
light walnut

BEW42WALW
42" wood

EDGEWOOD® DELUXE



FAN: TF710OB (1)
oil-rubbed bronze assembly
with reversible cherry/
walnut wood blades
• cherry side showing





oil-rubbed bronze	satin nickel	white
cherry walnut	light walnut walnut	white oak
TF710OB	TF710SN	TF710WH

INCLUDED:



blade set

ENERGY INFORMATION
AT HIGH SPEED:

			
FANSYNC™ sold separately	3-SPEED AC reverse switch on fan	CONTROL pull chain	DRY indoor only

Airflow	Electricity Use	Airflow Efficiency
8,963	84	106
Cubic Feet Per Minute	Watts (excluding lights)	Cubic Feet Per Minute Per Watt



LIMITED LIFETIME MOTOR WARRANTY



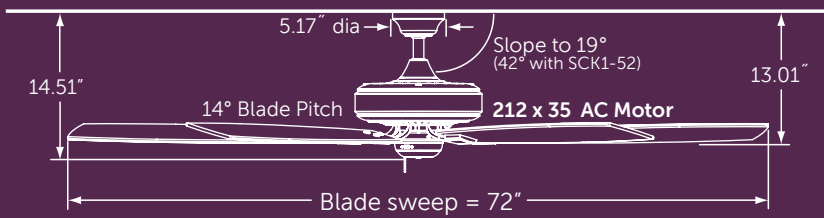

*With included 4.5" downrod—longer lengths available
Close-to-ceiling kit compatible

Net Hanging Weight: 37.92 lbs.



- FAN: TF721OB (1)**
- oil-rubbed bronze assembly with reversible cherry/walnut wood blades
- cherry side showing



- FAN: TF721WH (1)**
- white assembly with reversible white/white oak wood blades
- white side showing

For compatible controls & accessories



see pages 145 to 156

EDGEWOOD® SUPREME



FAN: TF721OB (1)
oil-rubbed bronze
assembly with
reversible cherry/
walnut wood blades
• cherry side showing

oil-rubbed bronze	white
cherry walnut	white oak
TF721OB	TF721WH

INCLUDED:



blade set

ENERGY INFORMATION AT HIGH SPEED:

- FANSYNC™**
sold separately
- 3-SPEED AC**
reverse switch
on fan
- CONTROL**
pull chain
- DRY**
indoor only

Airflow	Electricity Use	Airflow Efficiency
9,689	90	107
Cubic Feet Per Minute	Watts (excluding lights)	Cubic Feet Per Minute Per Watt



LIMITED LIFETIME MOTOR WARRANTY





For dimensions and configurations, please see our model-specific specification sheet, available at fanimation.com

Not recommended for use in sound sensitive areas.

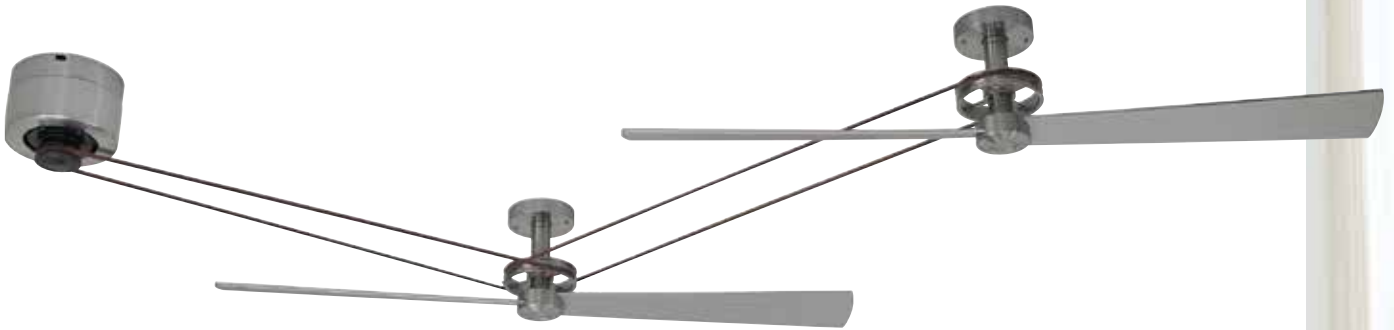

- ◆ **MOTOR: MA7966BN** (1)
brushed nickel
- HEAD: HA7966BN** (2)
brushed nickel assembly
- BLADE SET: B7966BN** (2)
56" sweep brushed nickel



- ◆ **MOTOR: MA7966DZ** (1)
dark bronze
- HEAD: HA7966DZ** (1)
dark bronze assembly
- BLADE SET: B7966CYDWA** (1)
56" sweep reversible
cherry/dark walnut
● dark walnut side showing

For compatible controls & accessories



see pages 145 to 148



BN—brushed nickel

CYDWA—cherry/dark
walnut reversible

B7966**
56" wood



KELLAN™

- ◆ **MOTOR: MA7966BN** (1)
brushed nickel
- ◆ **HEAD: HA7966BN** (1)
brushed nickel assembly
- ◆ **BLADE SET: B7966CYDWA** (1)
56" sweep reversible cherry/dark walnut
- dark walnut side showing

brushed nickel
MA7966BN
HA7966BN

dark bronze
MA7966DZ
HA7966DZ

MIX & MATCH
components
sold separately

3-SPEED AC
reverse switch
on remote

CONTROL
remote

DRY
indoor only

INCLUDED:



TR33 control

ENERGY INFORMATION
AT HIGH SPEED:

Airflow
4,659
Cubic Feet
Per Minute

Electricity Use
37
Watts
(excluding lights)

Airflow Efficiency
128
Cubic Feet Per
Minute Per Watt

LIMITED LIFETIME MOTOR WARRANTY



Due to their complex systems, multiple components and special installation requirements, we recommend contacting our Customer Service department for assistance with ordering—888.567.2055

For dimensions and configurations, please see our model-specific specification sheet, available at www.fanimation.com

BOURBON STREET®

- ◆ **MOTOR: FP580BL** (1)
black (required but not shown)
- ◆ **HEAD: FP510BL** (3)
black short assembly
- ◆ **BLADES: FP1018** (3)
52" sweep reversible oak/walnut wood
- oak side showing

PALMETTO®



FAN ASSEMBLY: FP602AB (1)
antique brass
● two sections shown
BLADES: PMD2AAB (6)
antique brass assemblies
with antique woven
bamboo wide oval blades







INDOOR/OUTDOOR

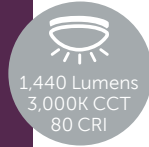
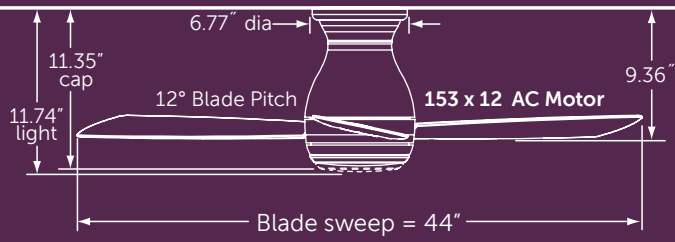

Net Hanging Weight: 13.89 lbs.

FAN: FPS8332BN (1)
brushed nickel assembly with opal frosted shade and brushed nickel blades



FAN: FPS8332DZ (1)
dark bronze assembly with dark bronze blades and matching light cover (included)



FAN: FPS8332GR (1)
matte greige assembly with opal frosted shade and matte greige blades



FAN: FPS8332MW (1)
matte white assembly with matte white blades and matching light cover (included)



For compatible
controls & accessories



see pages 145 to 148

HUGH™ 44

FAN: FPS8332BN (1)
brushed nickel assembly with
brushed nickel blades and
matching light cover (included)

brushed nickel	dark bronze	matte greige	matte white
brushed nickel	dark bronze	matte greige	matte white
FPS8332BN	FPS8332DZ	FPS8332GR	FPS8332MW

FANSYNC™
sold separately



(1) 18W LED

3-SPEED AC
reverse switch
on fan

CONTROL
wall

WET
indoor/outdoor

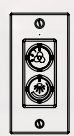
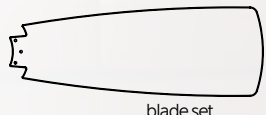
INCLUDED:



CW60WH-8332-8355
wall control

ENERGY INFORMATION AT HIGH SPEED:

Airflow
4,503
Cubic Feet Per Minute

Electricity Use
50
Watts
(excluding lights)

Airflow Efficiency
90
Cubic Feet Per Minute Per Watt

LIMITED LIFETIME MOTOR WARRANTY



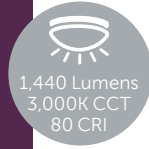
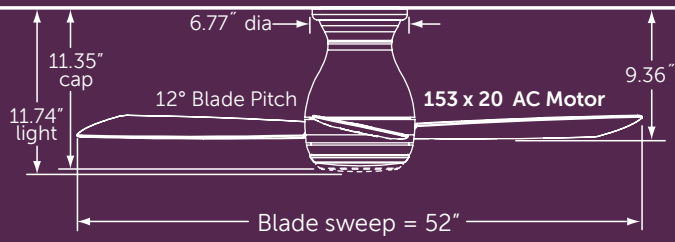

Net Hanging Weight: 16.53 lbs.

FAN: FPS8355BN (1)
brushed nickel assembly with opal frosted shade and brushed nickel blades



FAN: FPS8355DZ (1)
dark bronze assembly with dark bronze blades and matching light cover (included)



FAN: FPS8355GR (1)
matte greige assembly with opal frosted shade and matte greige blades



FAN: FPS8355MW (1)
matte white assembly with matte white blades and matching light cover (included)



For compatible
controls & accessories



see pages 145 to 148

HUGH™ 52

FAN: FPS8355GR (1)
matte greige assembly with
matte greige blades and
matching light cover (included)

brushed nickel	dark bronze	matte greige	matte white
brushed nickel	dark bronze	matte greige	matte white
FPS8355BN	FPS8355DZ	FPS8355GR	FPS8355MW

FANSYNC™
sold separately



**(1) 18W
LED**

**3-SPEED AC
reverse switch
on fan**

**CONTROL
wall**

**WET
indoor/outdoor**

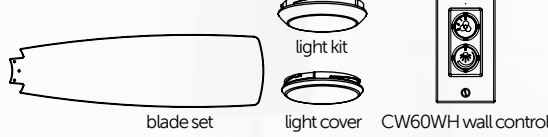
INCLUDED:



**ENERGY INFORMATION
AT HIGH SPEED:**

Airflow	Electricity Use	Airflow Efficiency
5,838	51	114
Cubic Feet Per Minute	Watts (excluding lights)	Cubic Feet Per Minute Per Watt

LIMITED LIFETIME MOTOR WARRANTY



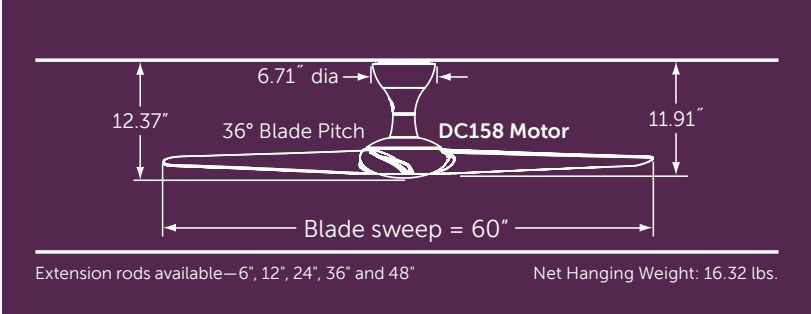

FAN: FPD6235SL (1)
silver assembly with silver blades
TUBE: ET6235-24SL (1)
silver 24" extension tube



FAN: FPD6235GBL (1)
glossy black assembly with glossy black blades



FAN: FPD6235GWH (1)
glossy white assembly with glossy white blades

Special features

FAN TIMER Sets timer for fan to turn off (max 6 hours)

FRESH AIR Variable fan speeds simulate a natural breeze.

For compatible controls & accessories



see pages 145 to 156

Extension tubes available in 6", 12", 24", 36" and 48"

Order by length and finish code

Example: ET6235-12_GWH
 |
 tube finish
 length code



GBL—glossy black

GWH—glossy white

SL—silver

ET6235-__***
extension tube

DRONE™



FAN: FPD6235SL (1)
silver assembly
with silver blades

glossy black	silver	glossy white
glossy black	silver	glossy white
FPD6235GBL	FPD6235SL	FPD6235GWH

- ENERGY SAVINGS
- FAN SYNC™ included
- 31-SPEED DC reverse switch on remote
- CONTROL remote
- DAMP indoor/outdoor

INCLUDED:

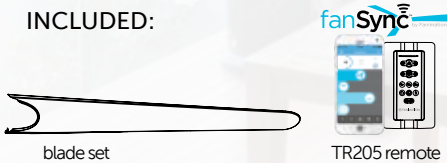

blade set

TR205 remote

ENERGY INFORMATION
AT HIGH SPEED:

Airflow	Electricity Use	Airflow Efficiency
8,877	37	242
Cubic Feet Per Minute	Watts (excluding lights)	Cubic Feet Per Minute Per Watt



LIMITED LIFETIME MOTOR WARRANTY



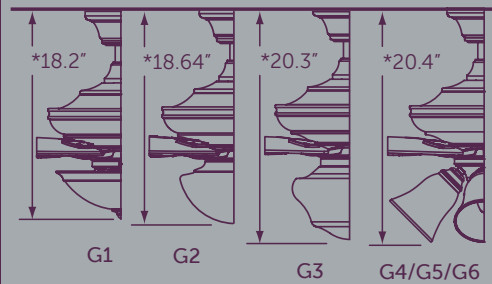
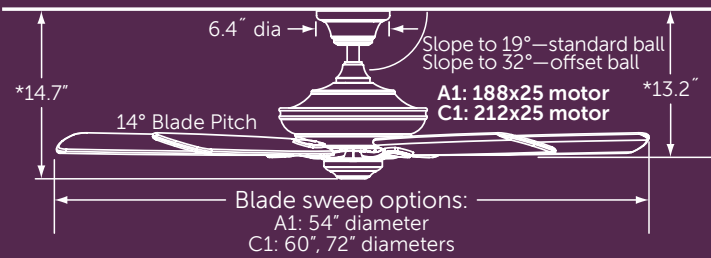

*With included 6" downrod—longer lengths available
 True stainless steel rust resistant downrods available
 A1 Net Hanging Weight: 23.53 lbs.
 C1 Net Hanging Weight: 26.63 lbs.



FAN: A1DZ (1)
 dark bronze assembly
BLADES: B754DWA (1)
 54" sweep dark walnut



FAN: C1BN (1)
 brushed nickel assembly
BLADES: B172DWA (1)
 72" sweep dark walnut
LIGHT FITTER: F2BN (1)
 brushed nickel globe fitter
GLASS: G3CL (1)
 clear schoolhouse glass globe
 ● shown with optional vintage bulb



FAN: A1MW (1)
 matte white assembly
BLADES: B254MW (1)
 54" sweep matte white



FAN: C1DZ (1)
 dark bronze assembly
BLADES: B560DWA (1)
 60" sweep dark walnut
LIGHT FITTER: F3DZ (1)
 dark bronze LED bowl fitter
GLASS: G1MS (1)
 marble swirl glass bowl



FAN: C1MW (1)
 matte white assembly
BLADES: B460CY (1)
 60" sweep cherry
LIGHT FITTER: F4MW (1)
 matte white 4 light fitter
GLASS: G5OP (4)
 2 1/4" opal frosted



For compatible controls & accessories



see inside fold for blades, fitters, glass & controls

My FANIMATION

DISTINCTION™ DC

-  **FAN: D1BN** (1)
brushed nickel assembly
- BLADES: B172DWA** (1)
72" sweep dark walnut
- LIGHT FITTER: F2BN** (1)
brushed nickel globe fitter
- GLASS: G3CL** (1)
clear schoolhouse glass globe
- shown with optional vintage bulb

brushed nickel
D1BN

dark bronze
D1DZ

matte white
D1MW



ENERGY SAVINGS



MIX & MATCH
components
sold separately



FANSYNC™
included



31-SPEED DC
reverse switch
on remote



CONTROL
remote



DAMP
indoor/outdoor

INCLUDED: fanSync



TR205 control

ENERGY INFORMATION
AT HIGH SPEED:

Airflow measured with
B172 blades

Airflow
7,680
Cubic Feet
Per Minute

Electricity Use
31
Watts
(excluding lights)

Airflow Efficiency
249
Cubic Feet Per
Minute Per Watt

Energy Star applies to specific blade
and motor and light kit combinations



LIMITED LIFETIME MOTOR WARRANTY



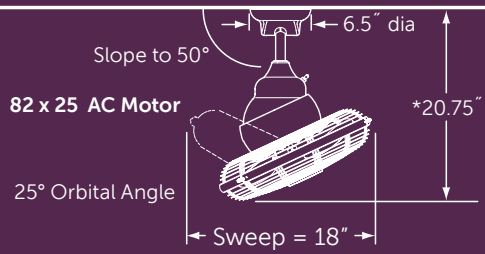

Net Hanging Weight: 14.5 lbs.

FAN: OF110BL (1)
black assembly with black cage



FAN: OF110OB (1)
oil-rubbed bronze assembly with black cage



FAN: OF110SN (1)
satin nickel assembly with black cage



For compatible
controls & accessories



see pages 145 to 156

My FANIMATION
 DISTINCTION™ AC

FAN: A1MW (1)
 matte white assembly
BLADES: B654MW (1)
 54" sweep matte white
LIGHT FITTER: F2MW (1)
 matte white globe fitter
GLASS: G2OP (1)
 opal frosted glass globe

brushed nickel
A1BN
C1BN

dark bronze
A1DZ
C1DZ

matte white
A1MW
C1MW



FAN SYNC™
 included

3-SPEED AC
 reverse switch
 on remote

CONTROL
 remote

DAMP
 indoor/outdoor

INCLUDED: fanSync™



BTT9R

ENERGY INFORMATION AT HIGH SPEED:

A1 airflow measured with B154** blades
 C1 airflow measured with B172** blades

	Airflow	Electricity Use	Airflow Efficiency
A1**	6,235	75	83
C1**	6,829	73	94
	Cubic Feet Per Minute	Watts (excluding lights)	Cubic Feet Per Minute Per Watt



Energy Star applies to specific blade and motor and light kit combinations

LIMITED LIFETIME MOTOR WARRANTY



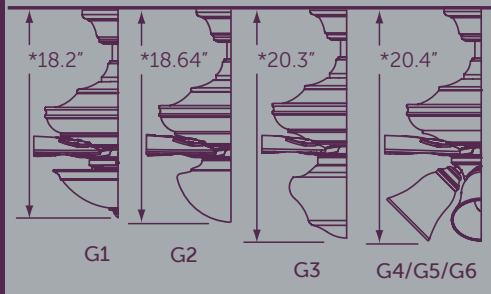
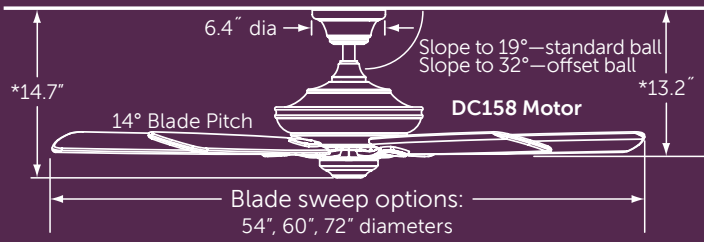

*With included 6" downrod—longer lengths available
 True stainless steel rust resistant downrods available
 Net Hanging Weight: 17.57 lbs.



FAN: D1DZ (1)
 dark bronze assembly
BLADES: B360CY (1)
 60" sweep cherry



FAN: D1BN (1)
 brushed nickel assembly
BLADES: B260DWA (1)
 60" sweep dark walnut
LIGHT FITTER: F4BN (1)
 brushed nickel 4 light fitter
GLASS: G4OPS (4)
 2 1/4" opal frosted shiny



FAN: D1MW (1)
 matte white assembly
BLADES: B654MW (1)
 54" sweep matte white
LIGHT FITTER: F2MW (1)
 matte white globe fitter
GLASS: G2OP (1)
 opal frosted glass globe



FAN: D1DZ (1)
 dark bronze assembly
BLADES: B154CY (1)
 54" sweep cherry
LIGHT FITTER: F1DZ (1)
 dark bronze bowl fitter
GLASS: G1TST (1)
 tea stain glass bowl



FAN: D1BN (1)
 brushed nickel assembly
BLADES: B860MW (1)
 60" sweep matte white



SOLD SEPARATELY:



See inside fold for blades, fitters, glass & controls

my FANIMATION
 DISTINCTION™

40+ YEARS OF DESIGNING AND
 ENGINEERING CEILING FANS



Tom Frampton, Founder and CEO of Fanimation knows ceiling fans. While a junior in high school, Tom went to work for a fan design and manufacturing company, gaining experience in most departments and learning every facet of the business. Fast forward over forty years and enter the myFanimation™ collection. Distinction, the first introduction under the collection, is defined by its clean design and advanced technology. The myFanimation™ collection is a culmination of his life's commitment to transforming the ceiling fan as we know it.

Two hanger balls: _____

- Standard—slope to 19°
- Offset—slope to 32°

Tri-mount system: _____

- Downrod straight
- Downrod slope
- Motor-to-canopy snigger

Outer canopy trim _____
 ring hides screws



DAMP
 indoor/outdoor
 (including blades
 and accessories)

Fan Shield™: _____

- Rubber grommets attach to the hub*
- The isolation ring system prevents noise and vibration from traveling from the motor through the blade holders and blades
- System is fail-safe and serviceable

No unsightly center screw _____

*Utility patent pending



myFanimation fans include fanSync™ smart device controls

AC: 3-SPEED INFINITE LIGHT FAN DIRECTION FAN TIMER SAFE EXIT
AC control via fanSync app only AC control via fanSync app only

DC: 31-SPEED INFINITE LIGHT FAN DIRECTION FAN TIMER FRESH AIR
 HOME AWAY SAFE EXIT

Unique features

FAN TIMER	Sets timer for fan & light to turn off (max 6 hours)	HOME AWAY	Light turns on and off at set intervals to simulate someone being home.
FRESH AIR	Variable fan speeds simulate a natural breeze.	SAFE EXIT	Fan & light will turn off after one minute to allow for safe exit

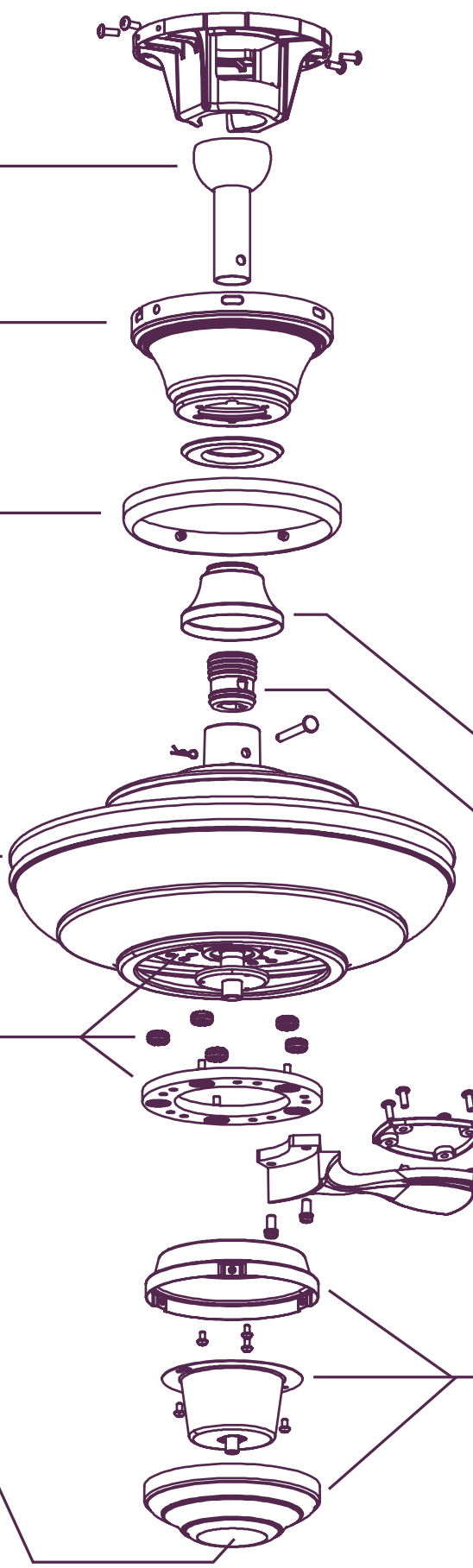

Decorative cover hides top support

Hang Right™:

- Rubber boot mounts in-between the down rod and top support*
- The downrod mounts perfectly straight and snug in the top support and does not offset or sit at angle from securing old style set screws
- No top support sets screws to loosen and vibrate
- The downrods mount faster onto the motor and without tools
- Less motor vibration travelling up the downrod and into the ceiling

Recessed screw holes in blade holder top piece hide screws from visibility

Switch cup cover hides screws

SIMPLE PART NUMBERING SYSTEM:

1. Motor: A, C or D

Example: A1BN

myFanimation motor finish code

2. Blades: B

Example: B160WA

myFanimation blade finish blade style sweep code

3. Fitter: F

Example: F1DZ

myFanimation fitter style finish code

4. Glass: G

Example: G2CL

myFanimation finish glass style code

1. Motors



A1 (188 x 25)

BN | DZ | MW

ENERGY INFORMATION

at High Speed*

Airflow	Electricity Use	Airflow Efficiency
5,849	77	76
Cubic Feet Per Minute	Watts (excluding lights)	Cubic Feet Per Minute Per Watt

*tested using B154 blade set

Order with 54" sweep blade sets only



C1 (212 x 25)

BN | DZ | MW

ENERGY INFORMATION

at High Speed*

Airflow	Electricity Use	Airflow Efficiency
8,900	89	100
Cubic Feet Per Minute	Watts (excluding lights)	Cubic Feet Per Minute Per Watt

*tested using B172 blade set

Order with 60" or 72" sweep blade sets only



D1 (DC158)

BN | DZ | MW

ENERGY INFORMATION

at High Speed*

Airflow	Electricity Use	Airflow Efficiency
8,800	32	275
Cubic Feet Per Minute	Watts (excluding lights)	Cubic Feet Per Minute Per Watt

*tested using B172 blade set

Order with 54", 60" or 72" sweep blade sets

Finish Codes

Motors:

BN	brushed nickel
DZ	dark bronze
MW	matte white

Blades:

CY	cherry
CYN	cherry with natural inlay
DC	dark cherry
DWA	dark walnut
MW	matte white
WA	walnut
WADWA	walnut with dark walnut inlay
WE	weathered wood

Light Kits:

BN	brushed nickel
DZ	dark bronze
MW	matte white

Glass:

CL	clear
FW	frosted white
MS	marble swirl
OP	opal frosted
OPS	opal frosted shiny
TST	tea stained

2. Blades



	B1			B2			B3			B4			B5		B6		B7		B8	
	54"	60"	72"	54"	60"	72"	54"	60"	72"	54"	60"	72"	54"	60"	54"	60"	54"	60"	54"	60"
CY	Ⓢ	Ⓢ	Ⓢ	Ⓢ	Ⓢ	Ⓢ	Ⓢ	Ⓢ	Ⓢ											
CYN										Ⓢ	Ⓢ	Ⓢ								
DC																			Ⓢ	Ⓢ
DWA	Ⓢ	Ⓢ	Ⓢ	Ⓢ	Ⓢ	Ⓢ	Ⓢ	Ⓢ	Ⓢ				Ⓢ	Ⓢ	Ⓢ	Ⓢ	Ⓢ	Ⓢ	Ⓢ	Ⓢ
MW	Ⓢ	Ⓢ	Ⓢ	Ⓢ	Ⓢ	Ⓢ	Ⓢ	Ⓢ	Ⓢ				Ⓢ	Ⓢ	Ⓢ	Ⓢ			Ⓢ	Ⓢ
WA	Ⓢ	Ⓢ	Ⓢ	Ⓢ	Ⓢ	Ⓢ	Ⓢ	Ⓢ	Ⓢ											
WADWA										Ⓢ	Ⓢ	Ⓢ								
WE	Ⓢ	Ⓢ	Ⓢ																	

my FANIMATION DISTINCTION™

3. Fitters

- Lumens: 1,650
- Color Temp: 2,700
- CRI: 99



F1		
BN	DZ	MW

- Lumens: 1,600
- Color Temp: 2,700
- CRI: 80



F2		
BN	DZ	MW

- Lumens: 1,350
- Color Temp: 3,000
- CRI: 80



F3		
BN	DZ	MW

- Lumens: 1,400
- Color Temp: 2,700
- CRI: 99



F4*		
BN	DZ	MW

4. Glass

	F1			F2			F3			F4*		
	G1	G2	G3	G1	G4	G5	G6					
CL			☉		☉		☉					
MS	☉			☉								
OP		☉	☉			☉	☉					
OPS			☉		☉							
TST	☉	☉		☉	☉	☉	☉					

*Additional glass available on page 154

5. Controls



For use with A1 and C1 motors		For use with D1 motor	
BTT9R —included	C21 —sold separately	TR205 —included	TW206 —sold separately
White hand-held remote control with wall mount	White wall control with wall plate	White hand-held remote control with wall mount	White wall control with wall plate

EXTRAORDINAIRE™



 **FAN: OF110OB** (1)
oil-rubbed bronze
assembly with black cage

black	oil-rubbed bronze	satin nickel
black	black	black
OF110BL	OF110OB	OF110SN

INCLUDED:



CW110WH wall control

ENERGY INFORMATION AT HIGH SPEED:

Airflow
847
Cubic Feet
Per Minute

Electricity Use
85
Watts
(excluding lights)

Airflow Efficiency
10
Cubic Feet Per
Minute Per Watt



3-SPEED AC
no reverse



CONTROL
wall



DAMP
indoor/outdoor

LIMITED LIFETIME MOTOR WARRANTY



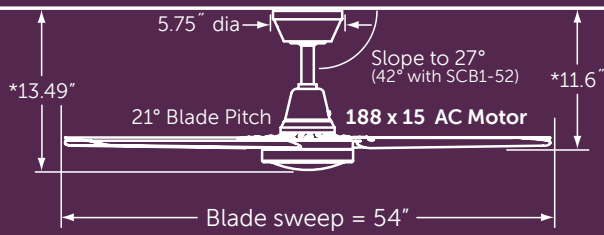

NOTE: DISTANCE FROM FLOOR TO BLADES MUST BE AT LEAST 10 FEET FOR THE ASCENSION™

*With included 6" downrod—longer lengths available
True stainless steel rust resistant downrods available

Net Hanging Weight: 18.44 lbs.



FAN: FP6717BN (1)
brushed nickel assembly with brushed nickel blades



FAN: FP6717MW (1)
matte white assembly with matte white blades



For compatible controls & accessories



see pages 145 to 156

ASCENSION™



FAN: FP6717BN (1)
brushed nickel assembly with
brushed nickel blades



brushed
nickel
brushed
nickel
FP6717BN

matte
white
matte
white
FP6717MW

INCLUDED:

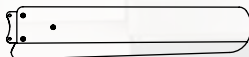

blade set



CW6717WH wall control

FANSYNC™
sold separately

3-SPEED AC
reverse switch
on fan

CONTROL
wall

DAMP
indoor/outdoor

ENERGY INFORMATION AT HIGH SPEED:

Airflow
6,659
Cubic Feet
Per Minute

Electricity Use
53
Watts
(excluding lights)

Airflow Efficiency
127
Cubic Feet Per
Minute Per Watt



LIMITED LIFETIME MOTOR WARRANTY



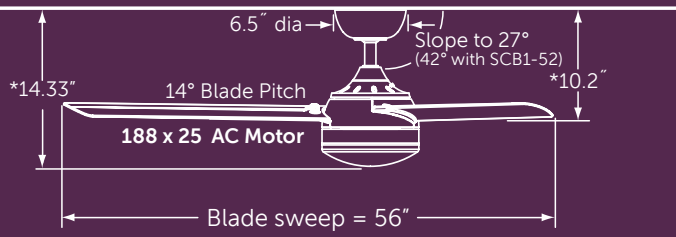



 1,350 Lumens
 3,000K CCT
 80 CRI

*With included 4.5" downrod—longer lengths available
 True stainless steel rust resistant downrods available
 Net Hanging Weight: 16.32 lbs.



FAN: FP6728BN (1)
 brushed nickel assembly with
 opal frosted glass and brushed
 nickel blades



FAN: FP6728DZ (1)
 dark bronze assembly with opal
 frosted glass and dark walnut
 blades

For compatible
controls & accessories



see pages 145 to 156

XENO™ DAMP



FAN: FP6728BN (1)
brushed nickel assembly
with opal frosted glass and
brushed nickel blades

brushed
nickel

brushed
nickel

FP6728BN

dark
bronze

dark
walnut

FP6728DZ

INCLUDED:

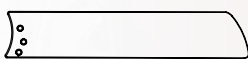

blade set



light kit



BTT9

ENERGY INFORMATION
AT HIGH SPEED:

Airflow
7,782
Cubic Feet
Per Minute

Electricity Use
58
Watts
(excluding lights)

Airflow Efficiency
135
Cubic Feet Per
Minute Per Watt



FANSYNC™
included



18W
LED



3-SPEED AC
reverse switch
on fan



CONTROL
remote



DAMP
indoor/outdoor



LIMITED LIFETIME MOTOR WARRANTY



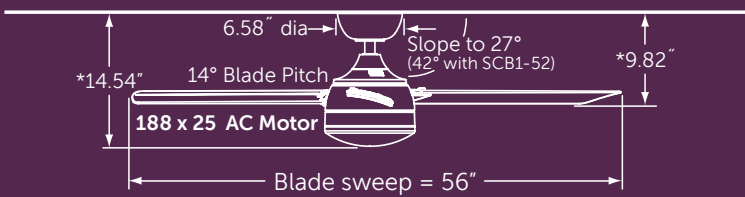

1,440 Lumens
3,000K CCT
80 CRI

*With included 4.5" downrod—longer lengths available Net Hanging Weight: 23.81 lbs.
Close-to-ceiling kit compatible; *True stainless steel rust resistant downrods available*



FAN: FP6729BNW (1)
brushed nickel assembly with
opal frosted glass and brushed
nickel blades



FAN: FP6729DZW (1)
dark bronze assembly with dark
bronze blades and matching
light cover (included)



FAN: FP6729MWW (1)
matte white assembly with matte
white blades and matching light
cover (included)



For compatible
controls & accessories



see pages 145 to 156

XENO™ WET



FAN: FP6729MWW (1)
matte white assembly with
matte white blades and
matching light cover (included)

brushed nickel	dark bronze	matte white
brushed nickel	dark bronze	matte white
FP6729BNW	FP6729DZW	FP6729MWW

FANSYNC™
sold separately

**18W
LED**

3-SPEED AC
reverse switch
on fan

CONTROL
wall

WET
indoor/outdoor

INCLUDED:

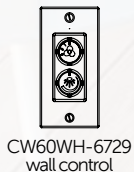
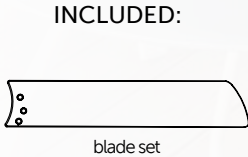

**ENERGY INFORMATION
AT HIGH SPEED:**

Airflow
7,782
Cubic Feet
Per Minute

Electricity Use
58
Watts
(excluding lights)

Airflow Efficiency
135
Cubic Feet Per
Minute Per Watt



LIMITED LIFETIME MOTOR WARRANTY



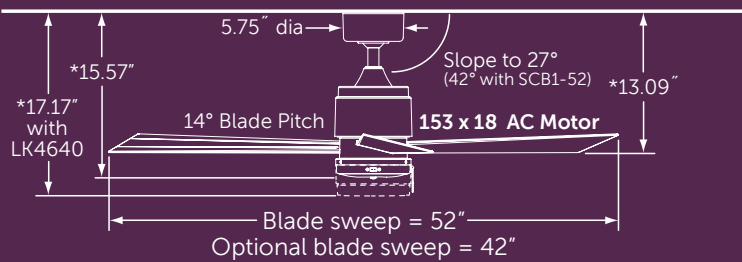



 1,300 Lumens
 3,000K CCT
 80 CRI

*With included 4.5" downrod—longer lengths available Net Hanging Weight: 14.7 lbs.
 Close-to-ceiling kit compatible; True stainless steel rust resistant downrods available

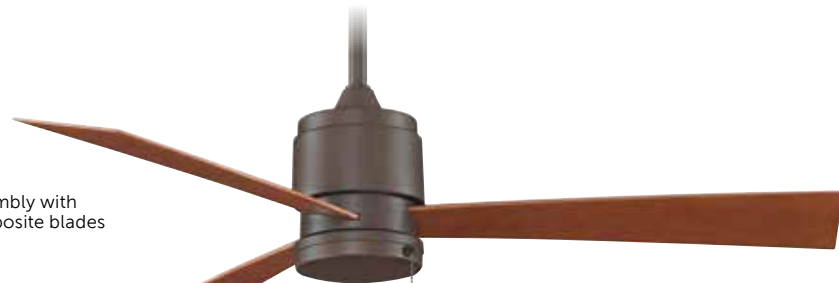

FAN: FP4640OB (1)
 oil-rubbed bronze assembly with
 cherry all weather composite blades



FAN: FP4640SN (1)
 satin nickel assembly with satin
 nickel all weather composite blades



FAN: FP4640WH (1)
 white assembly with white all
 weather composite blades



FAN: FP4640OB (1)
 oil-rubbed bronze
 assembly with cherry all
 weather composite blades
LIGHT KIT: LK4640OB (1)
 oil-rubbed bronze finish
 18W LED light kit



For compatible controls & accessories



see pages 145 to 156



CY—cherry

WA—walnut

BPW4426**
54" composite



CY—cherry

SN—satin nickel

WA—walnut

BPW4442**
42" composite



LK4640**
18W LED



use with
CW60WH



CW60WH
wall control

must be
paired
with WP60
for outdoor
application



WP60
waterproof box

ZONIX™ WET



FAN: FP4640OB(1)
oil rubbed bronze assembly with cherry all weather composite blades

oil-rubbed bronze

satin nickel

white

cherry

satin nickel

white

FP4640OB

FP4640SN

FP4640WH

INCLUDED:

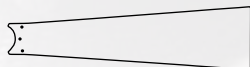

blade set

ENERGY INFORMATION AT HIGH SPEED:

FANSYNC™
sold separately

3-SPEED AC
reverse switch on fan

CONTROL
pull chain

WET
indoor/outdoor

Airflow
5,432
Cubic Feet Per Minute

Electricity Use
57
Watts (excluding lights)

Airflow Efficiency
96
Cubic Feet Per Minute Per Watt



LIMITED LIFETIME MOTOR WARRANTY



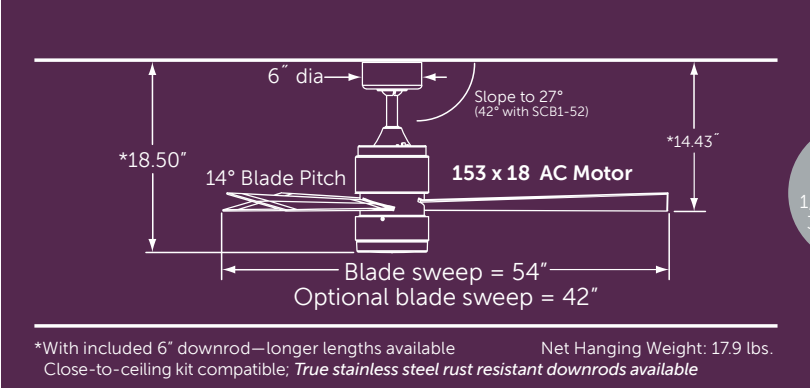

1,350 Lumens
3,000K CCT
80 CRI

FAN: FP4650BN (1)
brushed nickel assembly with
brushed nickel blades and
opal frosted glass



FAN: FP4650DCP (1)
dark copper penny assembly with
dark walnut blades and opal
frosted glass



FAN: FP4650OB (1)
oil-rubbed bronze assembly
with walnut blades and opal
frosted glass



For compatible
controls & accessories



see pages 145 to 156

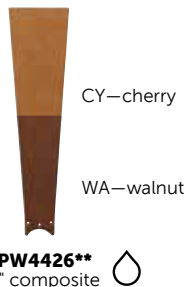
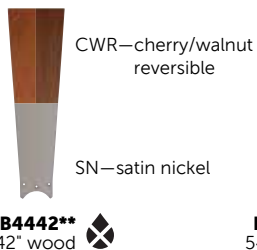

ZONIX™ LED

FAN: FP4650BN(1)
brushed nickel assembly with
brushed nickel blades and
opal frosted glass

brushed
nickel

brushed
nickel

FP4650BN

dark copper
penny

dark walnut

FP4650DCP

oil-rubbed
bronze

walnut

FP4650OB

FANSYNC™
sold separately

16W
LED

3-SPEED AC
reverse switch
on fan

CONTROL
remote

DAMP
indoor/outdoor

INCLUDED:



blade set



light kit



TR24WH remote

ENERGY INFORMATION AT HIGH SPEED:

Airflow
4,436
Cubic Feet
Per Minute

Electricity Use
57
Watts
(excluding lights)

Airflow Efficiency
78
Cubic Feet Per
Minute Per Watt

LIMITED LIFETIME MOTOR WARRANTY



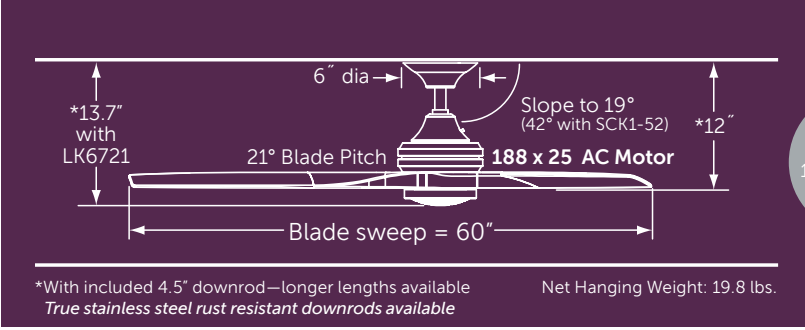

1,350 Lumens
3,000K CCT
80 CRI



FAN: MA6721BN (1)
brushed nickel assembly
BLADES: B6720BN (1)
brushed nickel finish buttonwood



FAN: MA6721BS (1)
brushed satin assembly
BLADES: B6720WK (1)
whiskey wood finish buttonwood



FAN: MA6721DF (1)
driftwood assembly
BLADES: B6720DF (1)
driftwood finish buttonwood



FAN: MA6721DZ (1)
dark bronze assembly
BLADES: B6720N (1)
natural finish buttonwood



FAN: MA6721GR (1)
matte greige assembly
BLADES: B6720WE (1)
weathered wood finish buttonwood



FAN: MA6721MW (1)
matte white assembly
BLADES: B6720WW (1)
white washed finish buttonwood
LIGHT KIT: LK6721MW (1)
matte white
OPTIONAL LENS: AP672113
frosted pc lens (replaces fresnel glass—sold separately)



For compatible controls & accessories



see pages 145 to 156



BN—brushed nickel
DF—driftwood
DWA—dark walnut
N—natural
WE—weathered wood
WK—whiskey wood
WW—white washed

B6720**
60" button wood



LK6721**
18W LED



AP672113
frosted pc lens

SPITFIRE™



FAN: MA6721DZ (1)
dark bronze assembly
BLADES: B6720N (1)
natural finish buttonwood
LIGHT KIT: LK6721DZ (1)
dark bronze with frosted fresnel glass

- brushed nickel
MA6721BN
- brushed satin
MA6721BS
- driftwood
MA6721DF
- dark bronze
MA6721DZ
- matte greige
MA6721GR
- matte white
MA6721MW

- FANSYNC™**
included
- MIX & MATCH**
components
sold separately
- 3-SPEED AC**
reverse switch
on fan
- CONTROL**
remote
- DAMP**
indoor/outdoor

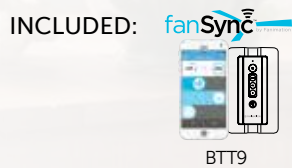

ENERGY INFORMATION AT HIGH SPEED:

Airflow	Electricity Use	Airflow Efficiency
6,641	61	108
Cubic Feet Per Minute	Watts (excluding lights)	Cubic Feet Per Minute Per Watt



LIMITED LIFETIME MOTOR WARRANTY



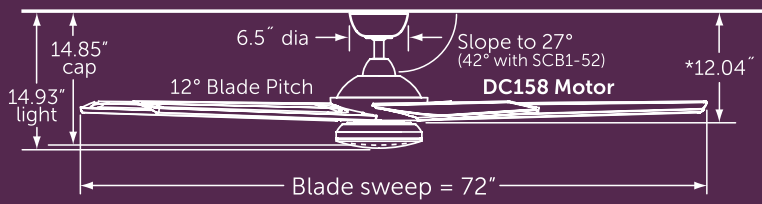

1,350 Lumens
3,000K CCT
80 CRI

*With included 6" downrod—longer lengths available
True stainless steel rust resistant downrods available

Net Hanging Weight: 26.5 lbs.



FAN: FPD6236BN (1)
brushed nickel assembly
with bourbon blades and
opal frosted glass



FAN: FPD6236DZ (1)
dark bronze assembly
with bourbon blades
and matching dark
bronze cap (included)

Special features



FAN TIMER

Sets timer for fan & light to turn off (max 6 hours)



HOME AWAY

Light turns on and off at set intervals to simulate someone being home.



FRESH AIR

Variable fan speeds simulate a natural breeze.



SAFE EXIT

Fan & light will turn off after one minute to allow for safe exit

For compatible controls & accessories



see pages 145 to 156

SUBTLE™



FAN: FPD6236DZ (1)
dark bronze assembly with bourbon blades and opal frosted glass

brushed nickel

dark bronze

bourbon

bourbon

FPD6236BN

FPD6236DZ



ENERGY SAVINGS



FANSYNC™ included



18W LED



31-SPEED DC reverse switch on remote



CONTROL remote



DAMP indoor/outdoor

INCLUDED:

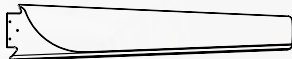

blade set



light kit



light cover



TR205 remote

ENERGY INFORMATION AT HIGH SPEED:

Airflow

8,197

Cubic Feet Per Minute

Electricity Use

40

Watts (excluding lights)

Airflow Efficiency

204

Cubic Feet Per Minute Per Watt



LIMITED LIFETIME MOTOR WARRANTY



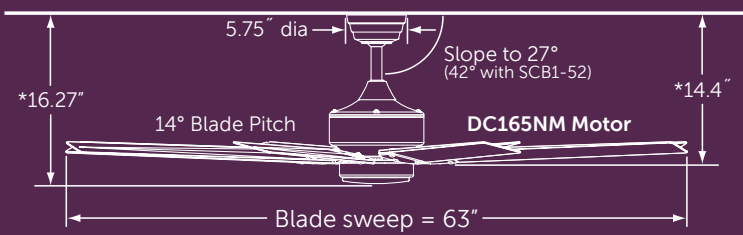



 1,350 Lumens
 3,000K CCT
 80 CRI

*With included 6" downrod—longer lengths available Net Hanging Weight: 28.18 lbs.
 Close-to-ceiling kit compatible; *True stainless steel rust resistant downrods available*



 **FAN: FPD7916BN (1)**
 brushed nickel assembly
 with brushed nickel blades
 and opal frosted glass



 **FAN: FPD7916DZ (1)**
 dark bronze assembly with
 dark walnut blades and
 opal frosted glass

For compatible controls & accessories

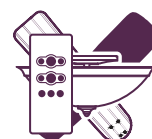

see pages 145 to 156

LEVON™ DC



FAN: FPD7916BN (1)
brushed nickel assembly
with brushed nickel blades
and opal frosted glass

brushed nickel	dark bronze
brushed nickel	dark walnut
FPD7916BN	FPD7916DZ

INCLUDED:

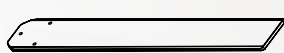

blade set



light kit

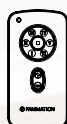

TR39 remote

ENERGY SAVINGS

18W LED

6-SPEED DC reverse switch on remote

CONTROL remote

DAMP indoor/outdoor

ENERGY INFORMATION AT HIGH SPEED:

Airflow
7,817
Cubic Feet Per Minute

Electricity Use
34
Watts (excluding lights)

Airflow Efficiency
230
Cubic Feet Per Minute Per Watt



LIMITED LIFETIME MOTOR WARRANTY



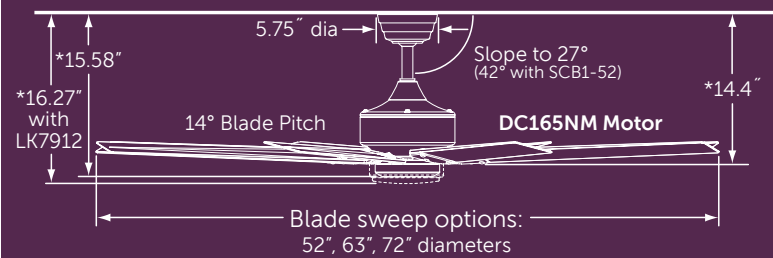



 1,350 Lumens
 3,000K CCT
 80 CRI

*With included 6" downrod—longer lengths available Net Hanging Weight: 18.96 lbs.
 Close-to-ceiling kit compatible; True stainless steel rust resistant downrods available





FAN: MAD7912BN (1)
 brushed nickel assembly
BLADES: B7913BN (1)
 72" sweep brushed nickel
 buttonwood
LIGHT KIT: LK7912BN (1)
 18W dimmable LED



FAN: MAD7912DZ (1)
 dark bronze assembly
BLADES: B7913CYWA (1)
 72" sweep cherry/walnut
 reversible buttonwood
 ● cherry side showing

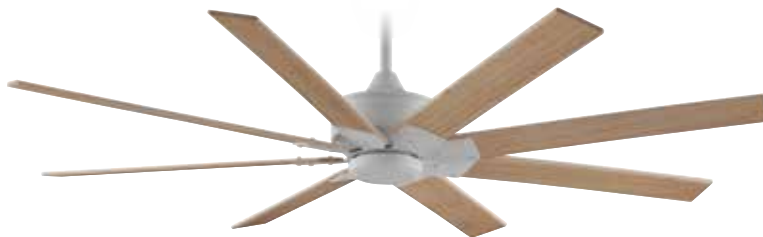

FAN: MAD7912MW (1)
 matte white assembly
BLADES: B7912N (1)
 63" sweep natural buttonwood



FAN: MAD7912DZ (1)
 dark bronze assembly
BLADES: B7914CYWA (1)
 52" sweep cherry/walnut
 reversible buttonwood
 ● walnut side showing





For compatible controls & accessories





see pages 145 to 156

 N—natural
 WA—walnut
 WP—washed pine
B7912**
 63" buttonwood

 BN—brushed nickel
 CYWA—cherry/walnut
 reversible
B7913**
 72" buttonwood



 BN—brushed nickel
 CYWA—cherry/walnut
 reversible
B7914**
 52" buttonwood

 BL—black
 BN—brushed nickel
 MW—matte white
BPW7912**
 63" composite



LK7912**
 18W LED

LEVON™ CUSTOM



 **FAN: MAD7912MW** (1)
 matte white assembly
BLADES: B7913CYWA (1)
 72" sweep reversible cherry/walnut
 • walnut side showing
LIGHT KIT: LK7912MW (1)
 18W dimmable LED

brushed nickel	dark bronze	matte white
MAD7912BN	MAD7912DZ	MAD7912MW

-  **ENERGY SAVINGS**
-  **MIX & MATCH**
components
sold separately
-  **6-SPEED DC**
reverse switch
on remote
-  **CONTROL**
remote
-  **DAMP**
indoor/outdoor

INCLUDED:



TR39 remote

ENERGY INFORMATION AT HIGH SPEED:

Airflow measured with
BPW7912** blades

Airflow
7,695
 Cubic Feet
 Per Minute

Electricity Use
34
 Watts
 (excluding lights)

Airflow Efficiency
226
 Cubic Feet Per
 Minute Per Watt



LIMITED LIFETIME MOTOR WARRANTY



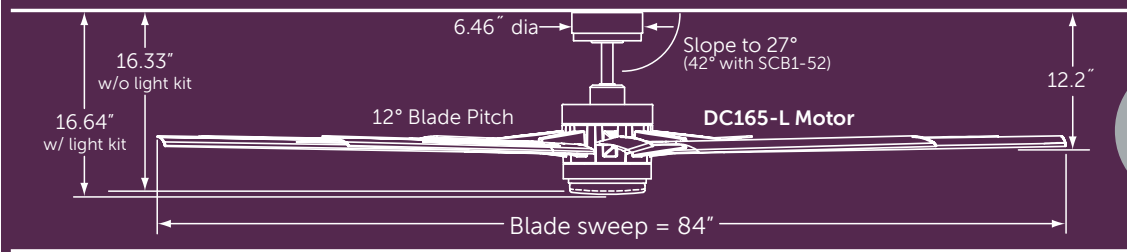



 1,350 Lumens
 3,000K CCT
 80 CRI

*With included 6" downrod—longer lengths available
 True stainless steel rust resistant downrods available

Net Hanging Weight: 32.14 lbs.





FAN: FPD8149BNWBL (1)
 brushed nickel assembly
 with black blades and opal
 frosted glass





FAN: FPD8149BNWBN (1)
 brushed nickel assembly with
 brushed nickel blades and
 matching brushed nickel light
 cover (included)





FAN: FPD8149DZW (1)
 dark bronze assembly with
 dark walnut blades and opal
 frosted glass



FAN: FPD8149GRW (1)
 matte greige assembly with
 weathered wood blades and
 matching matte greige light
 cover (included)



FAN: FPD8149MWW (1)
 matte white assembly with
 matte white blades and opal
 frosted glass



For compatible
controls & accessories



see pages 145 to 156

ODYN™



FAN: FPD8149GRW (1)
matte greige assembly with weathered wood blades and opal frosted glass

brushed nickel	brushed nickel	dark bronze	matte greige	matte white
black	brushed nickel	dark walnut	weathered wood	matte white
FPD8149BNWBL	FPD8149BNWBN	FPD8149DZW	FPD8149GRW	FPD8149MWW

- ENERGY SAVINGS
- 18W LED
- 6-SPEED DC reverse switch on remote
- CONTROL remote
- WET indoor/outdoor

INCLUDED:

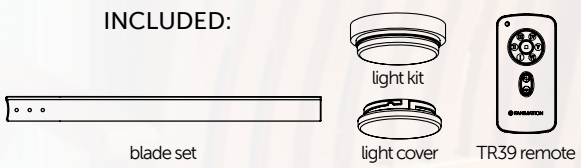

ENERGY INFORMATION AT HIGH SPEED:

Airflow	Electricity Use	Airflow Efficiency
11,190	32	348
Cubic Feet Per Minute	Watts (excluding lights)	Cubic Feet Per Minute Per Watt



LIMITED LIFETIME MOTOR WARRANTY



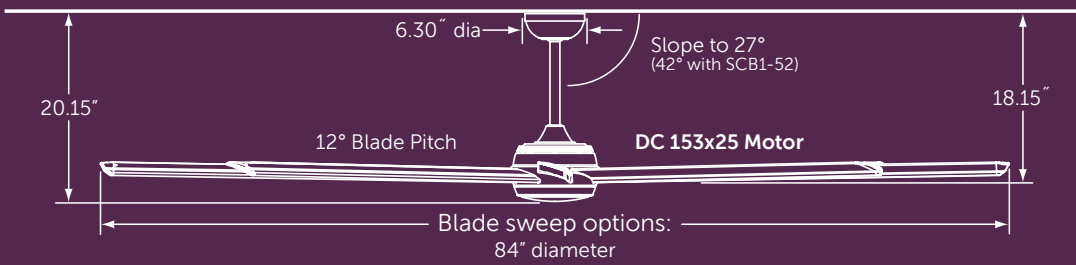

 1,440 Lumens
 3,000K CCT
 80 CRI

*With included 12" downrod—longer lengths available
 True stainless steel rust resistant downrods available

Net Hanging Weight w/84" blade set: 32.80 lbs.



FAN: MAD7993BLW (1)
 black assembly with silver accents
 and opal frosted glass
BLADES: B7993-84BLW (1)
 84" sweep black with silver wing tips



FAN: MAD7993SLW (1)
 silver assembly with black accents and
 matching light cover (included)
BLADES: B7993-84SLW (1)
 84" sweep silver with black wing tips



FAN: MAD7993SLW (1)
 silver assembly with black accents
 and opal frosted glass
BLADES: B7993-84BLW (1)
 84" sweep black with silver wing tips

For compatible controls & accessories



see pages 145 to 156



black with silver tips

B7993-84BLW
84" aluminum



silver with black tips

B7993-84SLW
84" aluminum

STELLAR™



FAN: MAD7993BLW (1)
black assembly with silver accents
and matching light cover (included)
BLADES: B7993-84SLW (1)
84" sweep silver with black wing tips

black silver
MAD7993BLW MAD7993SLW



ENERGY SAVINGS



MIX & MATCH
blades sold
separately



FAN SYNC™
included



18W
LED



31-SPEED DC
reverse switch
on remote



CONTROL
remote



WET
indoor/outdoor

INCLUDED:



light kit



light cover



TR205 remote

ENERGY INFORMATION
AT HIGH SPEED:

Airflow
11,223
Cubic Feet
Per Minute

Electricity Use
38
Watts
(excluding lights)

Airflow Efficiency
236
Cubic Feet Per
Minute Per Watt



LIMITED LIFETIME MOTOR WARRANTY



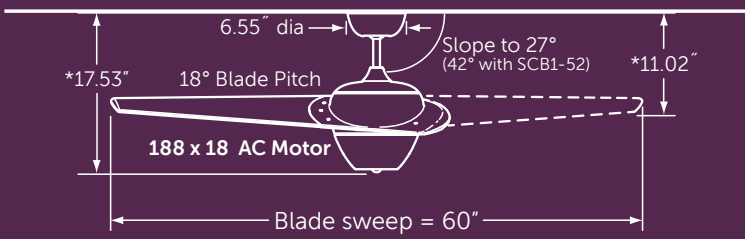

*With included 6" downrod—longer lengths available
 True stainless steel rust resistant downrods available

Net Hanging Weight: 38 lbs.

 **FAN: FP2120MG (1)**
 metro gray assembly with light
 socket cover (included)



 **FAN: FP2120MG (1)**
 metro gray assembly with light
 socket cover (included)



For compatible
 controls & accessories







see pages 145 to 156

ENIGMA™



FAN: FP2120MG (1)
metro gray assembly with light socket cover (included)

metro gray
metro gray
metro gray
FP2120MG

- 
FANSYNC™
sold separately
- 
11W
E26 LED
- 
3-SPEED AC
no reverse
- 
CONTROL
remote
- 
DAMP
indoor/outdoor

INCLUDED:

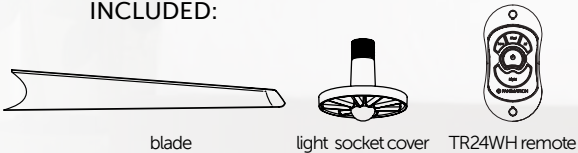

blade light socket cover TR24WH remote

ENERGY INFORMATION AT HIGH SPEED:

Airflow	Electricity Use	Airflow Efficiency
5,796	51	114
Cubic Feet Per Minute	Watts (excluding lights)	Cubic Feet Per Minute Per Watt

LIMITED LIFETIME MOTOR WARRANTY



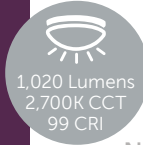
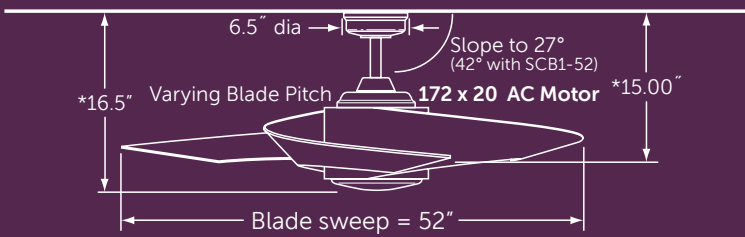

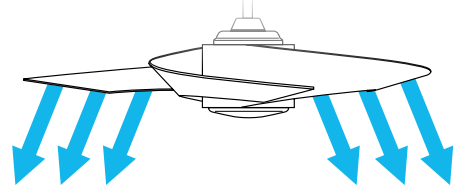

NOTE: AIRFLOW MOVES OUTWARD AT AN ANGLE INSTEAD OF DIRECTLY DOWNWARD



*With included 6" downrod—longer lengths available Net Hanging Weight: 27.4 lbs.
Close-to-ceiling kit compatible; True stainless steel rust resistant downrods available

 **FAN: FP7900BL** (1)
black assembly with
opal frosted glass



 **FAN: FP7900MG** (1)
metro gray assembly
with opal frosted glass



 **FAN: FP7900MW** (1)
matte white assembly
with opal frosted glass



 **FAN: FP7900OB** (1)
oil-rubbed bronze assembly
with opal frosted glass



For compatible
controls & accessories



see pages 145 to 156

TORTO™

FAN: FP7900BL (1)
black assembly with
opal frosted glass

black	metro gray	matte white	oil-rubbed bronze
black	metro gray	matte white	oil-rubbed bronze
FP7900BL	FP7900MG	FP7900MW	FP7900OB

FANSYNC™
sold separately

(2) 60W
incandescent
candelabra

3-SPEED AC
reverse switch
on remote

CONTROL
remote

DAMP
indoor/outdoor

INCLUDED:



blade set



light kit



TR20WH remote

**ENERGY INFORMATION
AT HIGH SPEED:**

Airflow
4,425
Cubic Feet
Per Minute

Electricity Use
80
Watts
(excluding lights)

Airflow Efficiency
56
Cubic Feet Per
Minute Per Watt

LIMITED LIFETIME MOTOR WARRANTY



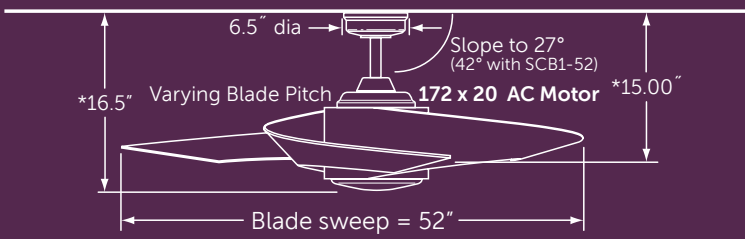

*With included 6" downrod—longer lengths available Net Hanging Weight: 27.4 lbs.
Close-to-ceiling kit compatible; *True stainless steel rust resistant downrods available*

1,350 Lumens
3,000K CCT
80 CRI

NOTE: AIRFLOW MOVES OUTWARD AT AN ANGLE INSTEAD OF DIRECTLY DOWNWARD

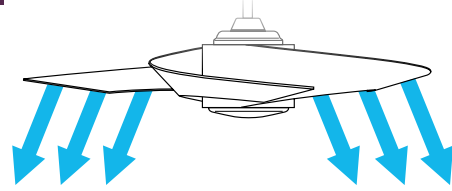

FAN: FP7902BN (1)
brushed nickel assembly with
18W LED opal frosted glass
and fanSync fan control

For compatible
controls & accessories



see pages 145 to 156

TORTO™ LED

 **FAN: FP7902BN(1)**
brushed nickel assembly with
18W LED opal frosted glass
and fanSync fan control

brushed
nickel
brushed
nickel
FP7902BN



FANSYNC™
included



18W
LED



3-SPEED AC
reverse switch
on remote



CONTROL
remote



DAMP
indoor/outdoor

INCLUDED:



blade set



light kit



BTT9R

ENERGY INFORMATION AT HIGH SPEED:

Airflow
4,425
Cubic Feet
Per Minute

Electricity Use
80
Watts
(excluding lights)

Airflow Efficiency
56
Cubic Feet Per
Minute Per Watt

LIMITED LIFETIME MOTOR WARRANTY



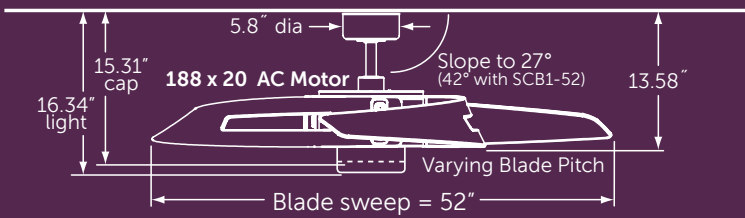



 1,176 Lumens
 2,800K CCT
 99 CRI

*With included 6" downrod—longer lengths available Net Hanging Weight: 28.4 lbs.
 Close-to-ceiling kit compatible; *True stainless steel rust resistant downrods available*

 **FAN: FP6210SN** (1)
 satin nickel assembly
 with walnut blades
 and opal frosted glass



 **FAN: FP6210OB** (1)
 oil-rubbed bronze assembly
 with cherry blades and opal
 frosted glass



 **FAN: FP6210OB** (1)
 satin nickel assembly with
 walnut blades and matching
 light cover (included)



For compatible controls & accessories







see pages 145 to 156

AVASTON™

FAN: FP6210OB (1)
oil-rubbed bronze assembly
with cherry blades and
matching light cover (included)

oil-rubbed bronze	satin nickel
cherry FP6210OB	walnut FP6210SN

-  **FANSYNC™**
sold separately
-  **(2) 50W**
halogen
minican
-  **3-SPEED AC**
reverse switch
on fan
-  **CONTROL**
remote
-  **DAMP**
indoor/outdoor

INCLUDED:

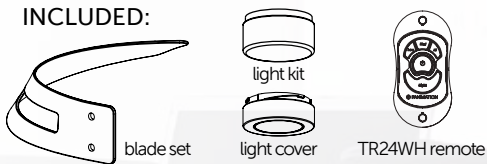

**ENERGY INFORMATION
AT HIGH SPEED:**

Airflow	Electricity Use	Airflow Efficiency
5,309	73	72
Cubic Feet Per Minute	Watts (excluding lights)	Cubic Feet Per Minute Per Watt

LIMITED LIFETIME MOTOR WARRANTY



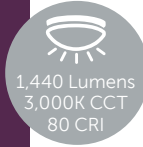
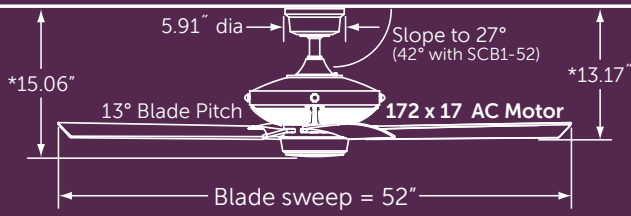

1,440 Lumens
3,000K CCT
80 CRI

*With included 4.5" downrod—longer lengths available Net Hanging Weight: 23.15 lbs.
Close-to-ceiling kit compatible; *True stainless steel rust resistant downrods available*



FAN: FP7996BLBNW (1)
black assembly with
brushed nickel accents,
opal frosted glass and
black blades



FAN: FP7996BLBSW (1)
black assembly with
brushed brass accents,
opal frosted glass and
black blades

For compatible
controls & accessories



see pages 145 to 156

PICKETT™



FAN: FP7996BLBNW (1)
black assembly with
brushed nickel accents,
opal frosted glass and
black blades

black with
brushed nickel

black with
brushed brass

black

black

FP7996BLBNW FP7996BLBSW



FANSYNC™
sold separately



18W
LED



3-SPEED AC
reverse switch
on fan



CONTROL
wall



WET
indoor/outdoor

INCLUDED:



blade set



light kit

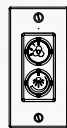

CW60WH-7996
wall control

ENERGY INFORMATION AT HIGH SPEED:

Airflow
6,270
Cubic Feet
Per Minute

Electricity Use
66
Watts
(excluding lights)

Airflow Efficiency
95
Cubic Feet Per
Minute Per Watt



LIMITED LIFETIME MOTOR WARRANTY



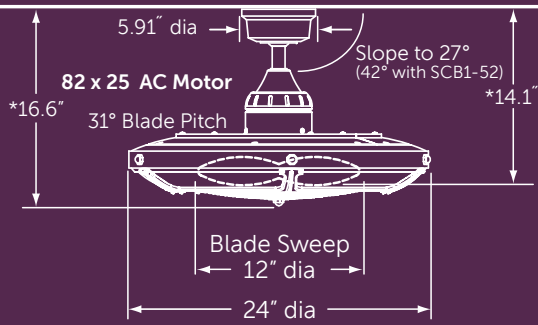



 2,200 Lumens
 3,000K CCT
 80 CRI

*With included 4.5" downrod—longer lengths available Net Hanging Weight: 25.85 lbs.
 Close-to-ceiling kit compatible; *True stainless steel rust resistant downrods available*



 **FAN: FP6260BLBN** (1)
 black assembly with brushed nickel accents, black blades and opal frosted glass



 **FAN: FP6260BLBS** (1)
 black assembly with brushed brass accents, black blades and opal frosted glass

For compatible controls & accessories



see pages 145 to 156

PICKETT™ DRUM

FAN: FP6260BLBN (1)
 black assembly with brushed nickel accents, black blades and opal frosted glass

black with brushed nickel	black with brushed brass
black	black
FP6260BLBN	FP6260BLBS

INCLUDED:



TR400 remote

ENERGY INFORMATION AT HIGH SPEED:

Airflow
744
 Cubic Feet Per Minute

Electricity Use
46
 Watts (excluding lights)

Airflow Efficiency
16
 Cubic Feet Per Minute Per Watt

- FANSYNC™** sold separately
- 23W LED strip**
- 3-SPEED AC** reverse switch on fan
- CONTROL** remote
- DAMP** indoor/outdoor

LIMITED LIFETIME MOTOR WARRANTY



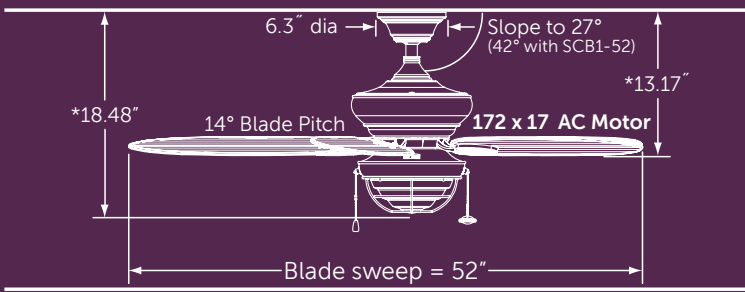



 1,600 Lumens
 2,700K CCT
 80 CRI

*With included 4.5" downrod—longer lengths available Net Hanging Weight: 23.13 lbs.
 Close-to-ceiling kit compatible; *True stainless steel rust resistant downrods available*



 **FAN: FP7963RS** (1)
 rust assembly with
 cherry bronze blades
 and opal frosted glass



For compatible
controls & accessories



see pages 145 to 156

KAYA™

FAN: FP7963RS (1)
rust assembly with
cherry bronze blades
and opal frosted glass

rust
cherry
bronze
FP7963RS

FANSYNC™
sold separately



**(1) 26W
GU24 CFL**

**3-SPEED AC
reverse switch
on fan**

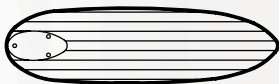

**CONTROL
pull chain**

**WET
indoor/outdoor**

INCLUDED:

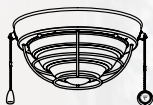

blade set



light kit

**ENERGY INFORMATION
AT HIGH SPEED:**

Airflow
4,995
Cubic Feet
Per Minute

Electricity Use
65
Watts
(excluding lights)

Airflow Efficiency
77
Cubic Feet Per
Minute Per Watt

LIMITED LIFETIME MOTOR WARRANTY



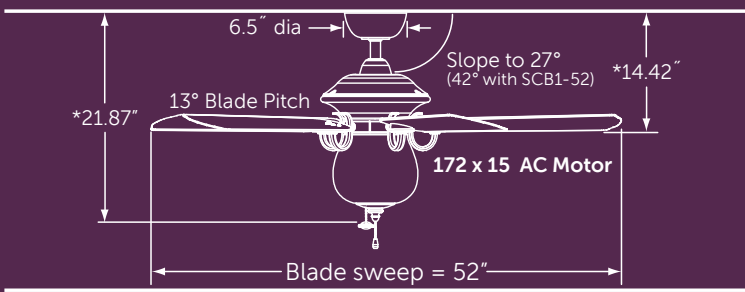

 1,020 Lumens
 2,700K CCT
 99 CRI

*With included 4.5" downrod—longer lengths available Net Hanging Weight: 22.9 lbs.
 Close-to-ceiling kit compatible; *True stainless steel rust resistant downrods available*



FAN: FP7954OB (1)
 oil-rubbed bronze assembly with
 seeded glass light kit and reversible
 cherry/walnut composite blades

- cherry side showing



FAN: FP7954OB (1)
 oil-rubbed bronze assembly with
 seeded glass light kit and reversible
 cherry/walnut composite blades

- walnut side showing

For compatible
controls & accessories



see pages 145 to 156

CRESTFORD™

FAN: FP7954OB (1)
oil-rubbed bronze assembly
with seeded glass light kit
and reversible cherry/walnut
composite blades
• cherry side showing

oil-rubbed
bronze
cherry/walnut
FP7954OB

FANSYNC™
sold separately



(3) 40W
incandescent
candelabra

3-SPEED AC
reverse switch
on fan

CONTROL
pull chain

WET
indoor/outdoor

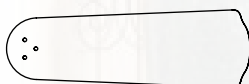
INCLUDED:



blade set



light kit

ENERGY INFORMATION AT HIGH SPEED:

Airflow
5,803
Cubic Feet
Per Minute

Electricity Use
59
Watts
(excluding lights)

Airflow Efficiency
99
Cubic Feet Per
Minute Per Watt

LIMITED LIFETIME MOTOR WARRANTY



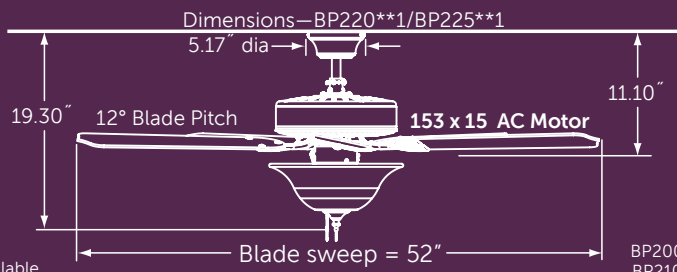
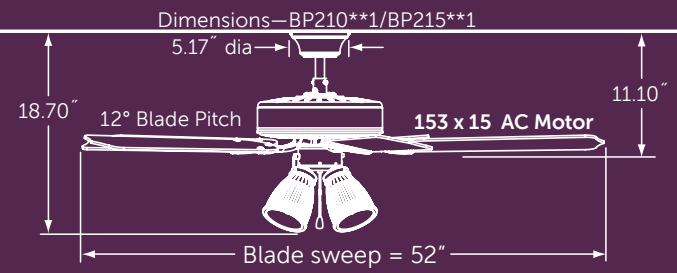
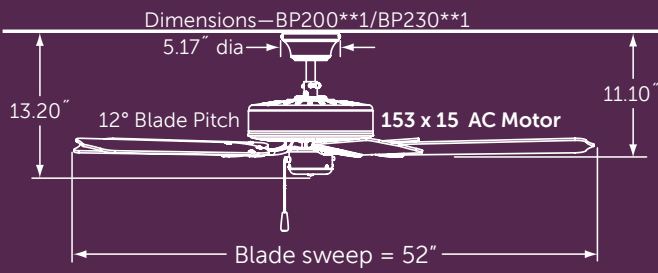



 1,360 Lumens
 2,700K CCT
 99 CRI

*With included 4.5" downrod—longer lengths available
 True stainless steel rust resistant downrods available

BP200**1/BP230**1 Net Hanging Weight: 16.31 lbs.
 BP210**1/BP215**1 Net Hanging Weight: 20.94 lbs.
 BP220**1/BP225**1 Net Hanging Weight: 18.5 lbs.

 **FAN: BP200SN1 (1)**
 satin nickel assembly in flush-mount configuration with reversible cherry/walnut wood blades
 ● walnut side showing



 **FAN: BP210MW1 (1)**
 matte white assembly in downrod configuration with white frosted glass shades and matte white wood blades



 **FAN: BP215OB1 (1)**
 oil-rubbed bronze assembly in downrod configuration with white frosted glass shades (amber shades version available: BP210OB1) and reversible cherry/walnut wood blades
 ● cherry side showing



 **FAN: BP230BL1 (1)**
 black assembly in downrod configuration with black blades



For compatible controls & accessories

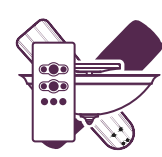

see pages 145 to 156

AIRE DECOR®



FAN: BP220SN1 (1)
satin nickel assembly in
downrod configuration with
white frosted glass bowl and
reversible cherry/walnut blades
● walnut side showing



FAN: BP220MW1 (1)
matte white assembly in
downrod configuration with
white frosted glass bowl and
matte white wood blades



FAN: BP225OB1 (1)
oil-rubbed bronze assembly
in downrod configuration
with white frosted glass bowl
(amber glass version available:
BP220OB1) and cherry/walnut
reversible wood blades
● walnut side showing

black	matte white	oil-rubbed bronze	oil-rubbed bronze	satin nickel	satin nickel
black	matte white	cherry walnut	walnut	cherry walnut	cherry
BP230BL1	BP200MW1 BP210MW1 BP220MW1 BP230MW1	BP200OB1 BP210OB1 BP215OB1 BP220OB1 BP225OB1	BP230OB1	BP200SN1 BP210SN1 BP220SN1	BP230SN1

- FANSYNC™ sold separately
- SEE INCLUDED incandescent candelabra
- 3-SPEED AC reverse switch on fan
- CONTROL pull chain
- DRY OR DAMP model specific

INCLUDED:



ENERGY INFORMATION AT HIGH SPEED:

Airflow	Electricity Use	Airflow Efficiency
5,849	64	91
Cubic Feet Per Minute	Watts (excluding lights)	Cubic Feet Per Minute Per Watt

LIMITED LIFETIME MOTOR WARRANTY



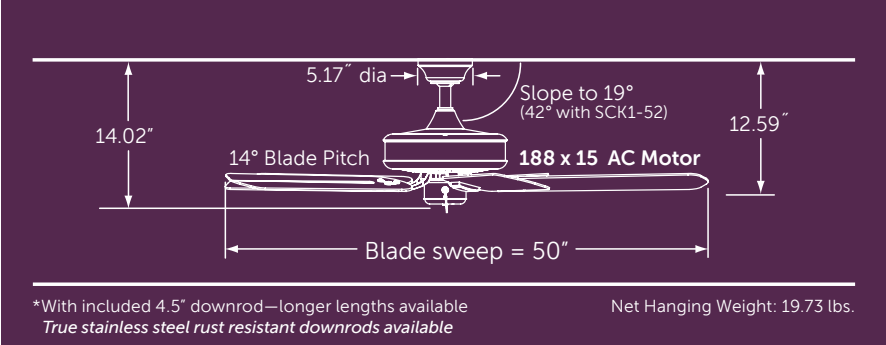

FAN: TF910AZ (1)
aged bronze assembly with dark cherry all-weather composite blades



FAN: TF910BL (1)
black assembly with black all-weather composite blades



FAN: TF910OB (1)
oil-rubbed bronze assembly with dark cherry all-weather composite blades



FAN: TF910WH (1)
white assembly with white all-weather composite blades



For compatible controls & accessories



see pages 145 to 156

EDGEWOOD® WET



FAN: TF910WH(1)
white assembly with all-weather composite white blades

aged bronze dark cherry TF910AZ	black black TF910BL	oil-rubbed bronze dark cherry TF910OB	white white TF910WH
--	----------------------------------	--	----------------------------------

INCLUDED:



blade set

ENERGY INFORMATION
AT HIGH SPEED:

FANSYNC™
sold separately

3-SPEED AC
reverse switch
on fan

CONTROL
pull chain

WET
indoor/outdoor

Airflow
5,461
Cubic Feet
Per Minute

Electricity Use
54
Watts
(excluding lights)

Airflow Efficiency
102
Cubic Feet Per
Minute Per Watt



LIMITED LIFETIME MOTOR WARRANTY



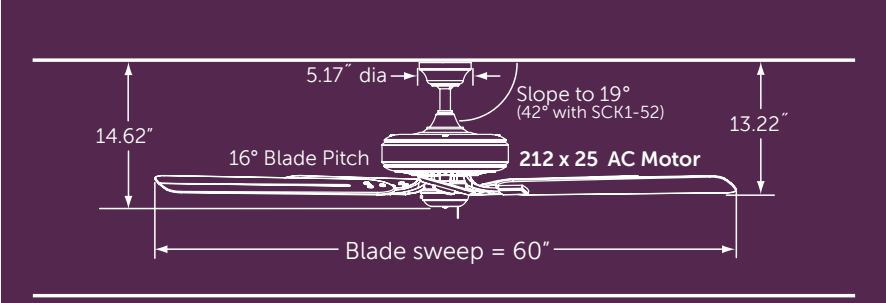

*With included 4.5" downrod—longer lengths available Net Hanging Weight: 32.1 lbs.
 Close-to-ceiling kit compatible; True stainless steel rust resistant downrods available



FAN: TF971AZ (1)
 aged bronze assembly with dark cherry all-weather composite blades



FAN: TF971OB (1)
 oil-rubbed bronze assembly with dark cherry all-weather composite blades



FAN: TF971WH (1)
 white assembly with white all-weather composite blades



For compatible controls & accessories



see pages 145 to 156

EDGEWOOD® DELUXE WET



FAN: TF971AZ (1)
aged bronze assembly with
all-weather composite
dark cherry blades

aged
bronze

TF971AZ

oil-rubbed
bronze

TF971OB

white

white

TF971WH

INCLUDED:

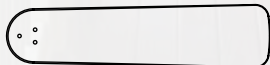

blade set

ENERGY INFORMATION
AT HIGH SPEED:

FANSYNC™
sold separately

3-SPEED AC
reverse switch
on fan

CONTROL
pull chain

WET
indoor/outdoor

Airflow
8,963
Cubic Feet
Per Minute

Electricity Use
107
Watts
(excluding lights)

Airflow Efficiency
84
Cubic Feet Per
Minute Per Watt



LIMITED LIFETIME MOTOR WARRANTY



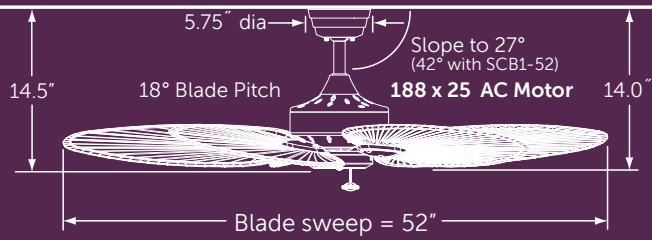

*With included 6" downrod—longer lengths available
Close-to-ceiling kit compatible
True stainless steel rust resistant downrods available

FP7500AB Net Hanging Weight: 23.84 lbs.
FP7500MW Net Hanging Weight: 26.66 lbs.
FP7500OBP4 Net Hanging Weight: 29.87 lbs.
FP7500RS Net Hanging Weight: 25.41 lbs.

FAN: FP7500AB (1)
52" sweep antique brass assembly
with natural palm narrow oval blades



FAN: FP7500MW (1)
52" sweep matte white assembly
with natural palm narrow oval blades



FAN: FP7500OBP4 (1)
52" sweep oil-rubbed bronze
assembly with all weather composite
red/brown narrow oval palm blades



FAN: FP7500RS (1)
52" sweep rust assembly with antique
woven bamboo narrow oval blades

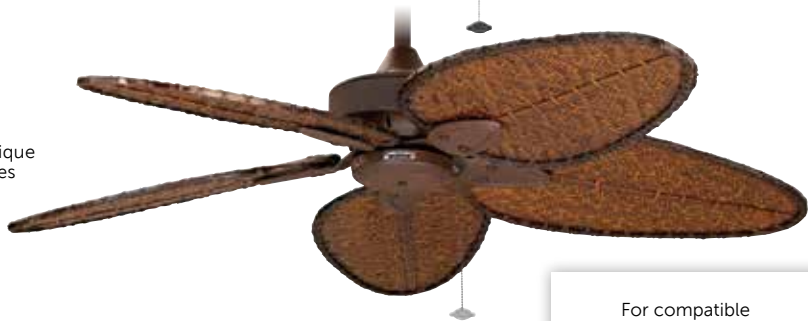

For compatible
controls & accessories



see pages 145 to 156

WINDPOINTE®



FAN: FP7500AB (1)
52" sweep antique brass assembly with natural narrow oval palm blades

antique brass natural palm FP7500AB	matte white natural palm FP7500MW	oil-rubbed bronze red/brown palm FP7500OBP4	rust antique bamboo FP7500RS
---	---	---	------------------------------------

FANSYNC™
sold separately

3-SPEED AC
reverse switch
on fan

CONTROL
pull chain

DRY OR DAMP
model specific

INCLUDED:



blade set

ENERGY INFORMATION
AT HIGH SPEED:

FP7500AB	Airflow	2,633
FP7500MW	Airflow	2,812
FP7500OBP4	Airflow	4,054
FP7500RS	Airflow	2,551

Cubic Feet
Per Minute

Electricity Use
42
42
50
42
Watts
(excluding lights)

Airflow Efficiency
63
67
81
60
Cubic Feet Per
Minute Per Watt

LIMITED LIFETIME MOTOR WARRANTY



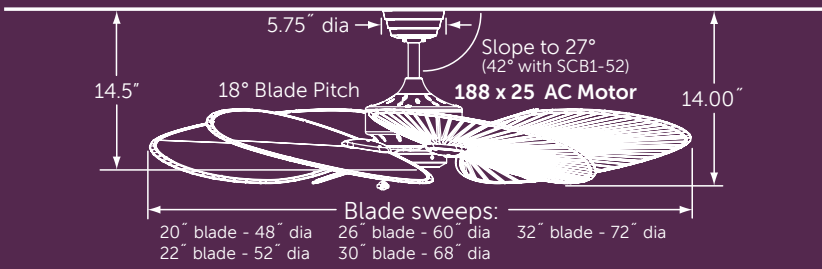

*With included 6" downrod—longer lengths available
Close-to-ceiling kit compatible; *True stainless steel rust resistant downrods available*

Net Hanging Weight: 24.87 lbs.

FAN: MA7500AB (1)
antique brass assembly
BLADES: B5340WA (1)
52" sweep walnut carved wood



FAN: MA7500MW (1)
matte white assembly
BLADES: BPW6090DNA (1)
60" sweep all-weather composite dark natural accent narrow palm



FAN: MA7500OB (1)
oil-rubbed bronze assembly
BLADES: BPW20CY (1)
48" sweep all-weather composite cherry
LIGHT KIT: LKLP102OB (1)
opal frosted glass low profile
CLOSE TO CEILING KIT: CCK8002OB (1)
oil-rubbed bronze



FAN: MA7500PW (1)
pewter assembly
BLADES: ISD1A (1)
52" sweep antique wide oval woven bamboo



FAN: MA7500RS (1)
rust assembly
BLADES: B5280WA (1)
52" sweep walnut wide oval leaf carved wood



For compatible
controls & accessories



see pages 145 to 158

WINDPOINTE® CUSTOM

FAN: MA7500MW (1)
matte white assembly
BLADES: BPW6090DNA (1)
60" sweep all-weather
composite dark natural
accent narrow palm

antique brass MA7500AB matte white MA7500MW oil-rubbed bronze MA7500OB pewter MA7500PW rust MA7500RS

FANSYNC™
sold separately

MIX & MATCH
components
sold separately

3-SPEED AC
reverse switch
on fan

CONTROL
pull chain

DRY OR DAMP
model specific

ENERGY INFORMATION
AT HIGH SPEED:
Airflow measured with
B5280WA blades

Airflow
4,649
Cubic Feet
Per Minute

Electricity Use
46
Watts
(excluding lights)

Airflow Efficiency
101
Cubic Feet Per
Minute Per Watt

LIMITED LIFETIME MOTOR WARRANTY



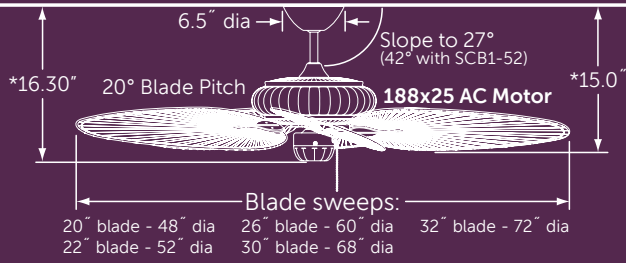

*With included 6" downrod—longer lengths available
Close-to-ceiling kit compatible; *True stainless steel rust resistant downrods available*

Net Hanging Weight: 25.0 lbs.

FAN: FP4320AZ1 (1)
aged bronze assembly
BLADES: BPD4A (1)
52" sweep all-weather
composite antique woven
bamboo narrow oval



FAN: FP4320MW1 (1)
matte white assembly
BLADES: BPP4TN (1)
52" sweep natural palm
finish narrow oval all-
weather composite



FAN: FP4320TB1 (1)
textured black assembly
BLADES: BPP4BR (1)
52" sweep brown/red palm
narrow oval all-weather
composite



FAN: FP4320TS1 (1)
tortoise shell assembly
BLADES: B5340WA (1)
52" sweep walnut
carved wood



For compatible
controls & accessories



see pages 145 to 158

BELLERIA®

FAN: FP4320AZ1 (1)
 aged bronze assembly
BLADES: BPW6090DNA (1)
 60" sweep all-weather composite
 dark natural accent narrow palm

aged bronze

FP4320AZ1

matte white

FP4320MW1

textured black

FP4320TB1

tortoise shell

FP4320TS1



FANSYNC™
sold separately



MIX & MATCH
components
sold separately



3-SPEED AC
reverse switch
on fan



CONTROL
pull chain



DRY or WET
blade finish
specific

ENERGY INFORMATION AT HIGH SPEED:

Airflow measured with
BPW6090DNA blades

Airflow

5,217

Cubic Feet
Per Minute

Electricity Use

68

Watts
(excluding lights)

Airflow Efficiency

77

Cubic Feet Per
Minute Per Watt

LIMITED LIFETIME MOTOR WARRANTY



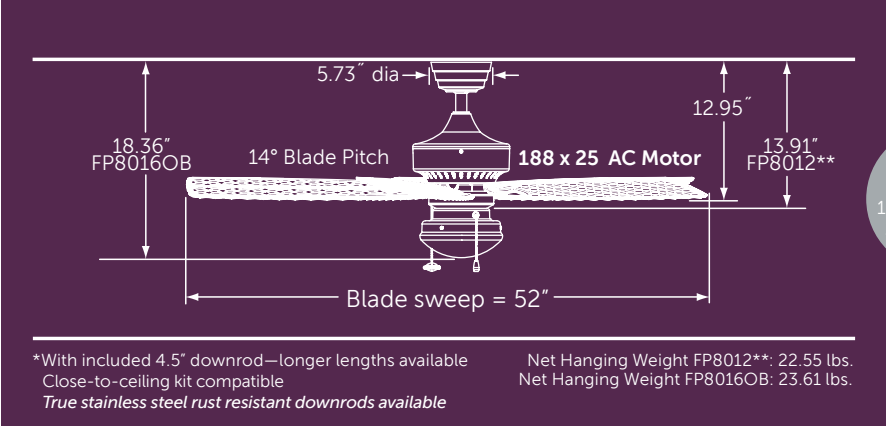

1,600 Lumens
2,800K CCT
99 CRI



FAN: FP8012OB (1)
oil-rubbed bronze assembly with all-weather composite antique woven bamboo blades



FAN: FP8012WH (1)
white assembly with all-weather composite white woven bamboo blades



FAN: FP8016OB (1)
oil-rubbed bronze assembly with frosted white low profile light kit and all-weather composite antique woven bamboo blades



For compatible controls & accessories



see pages 145 to 156

CANCUN™ WET

FAN: FP8016OB (1)
oil-rubbed bronze assembly with frosted white low profile light kit and all-weather composite antique woven bamboo blades

oil-rubbed bronze
antique bamboo

FP8012OB
FP8016OB

white
white bamboo

FP8012WH

INCLUDED:



blade set



light kit—FP8016OB only



FANSYNC™
sold separately



(1) 100W
halogen
minican
FP8016OB



3-SPEED AC
reverse switch
on fan



CONTROL
pull chain



WET
indoor/outdoor

ENERGY INFORMATION AT HIGH SPEED:

Airflow
5,715
Cubic Feet
Per Minute

Electricity Use
70
Watts
(excluding lights)

Airflow Efficiency
82
Cubic Feet Per
Minute Per Watt

FP8012** only



LIMITED LIFETIME MOTOR WARRANTY



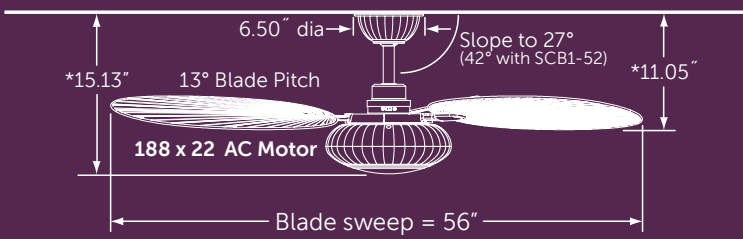

1,440 Lumens
3,000K CCT
80 CRI

*With included 6" downrod—longer lengths available Net Hanging Weight: 24.69 lbs.
Close-to-ceiling kit compatible; True stainless steel rust resistant downrods available



FAN: FP6258BNMW (1)
brushed nickel and matte white
fan with matte white blades and
matte white light cover (included)



FAN: FP6258BNMW (1)
brushed nickel and matte
white fan with matte white
blades and opal frosted shade



For compatible
controls & accessories



see pages 145 to 156

PALMA™



FAN: FP6258BNMW (1)
brushed nickel and matte white fan with matte white blades and opal frosted shade

brushed nickel
matte white
FP6258BNMW

FANSYNC™
sold separately



18W LED

3-SPEED AC
reverse switch on fan

CONTROL
wall

DAMP
indoor/outdoor

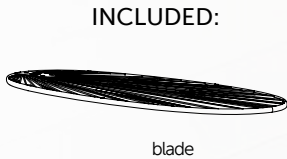
INCLUDED:



blade



light kit

light cover



CW60WH-6258
wall control

ENERGY INFORMATION AT HIGH SPEED:

Airflow
6,508
Cubic Feet Per Minute

Electricity Use
76
Watts (excluding lights)

Airflow Efficiency
86
Cubic Feet Per Minute Per Watt



LIMITED LIFETIME MOTOR WARRANTY



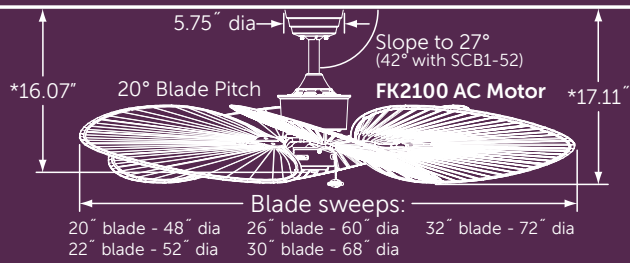

*With included 6" downrod—longer lengths available
True stainless steel rust resistant downrods available

Net Hanging Weight: 19.0 lbs.

- ◆ **FAN: FP320AB1** (1)
antique brass assembly
BLADES: ISP1 (1)
52" sweep natural palm leaf wide oval

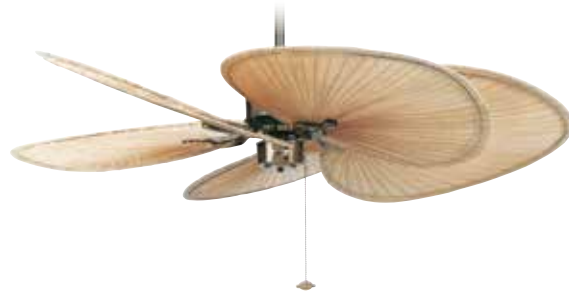

- **FAN: FP320OB1** (1)
oil-rubbed bronze assembly
BLADES: BPW20CY (1)
48" sweep all-weather composite cherry



- ◆ **FAN: FP320PW1** (1)
pewter assembly
BLADES: B5133TKMH (1)
52" sweep reversible teak/
mahogany wood blades
● teak side showing



- **FAN: FP320RS1** (1)
rust assembly
BLADES: ISD1A (1)
52" sweep antique wide oval
woven bamboo

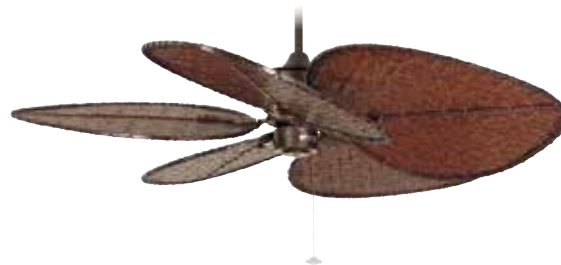

For compatible
controls & accessories



see pages 145 to 158

ISLANDER® AC

 **FAN: FP320RS1** (1)
 rust assembly
BLADE SET: ISP1 (1)
 52" sweep natural palm
 leaf wide oval

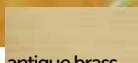
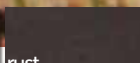
- 
 antique brass
FP320AB1
- 
 oil-rubbed
 bronze
FP320OB1
- 
 pewter
FP320PW1
- 
 rust
FP320RS1

FANSYNC™
 sold separately

MIX & MATCH
 components
 sold separately

3-SPEED AC
 reverse switch
 on fan

CONTROL
 pull chain

DRY OR DAMP
 model specific

ENERGY INFORMATION
AT HIGH SPEED:
Airflow measured with
 BPD4A blades

Airflow
4,010
 Cubic Feet
 Per Minute

Electricity Use
85
 Watts
 (excluding lights)

Airflow Efficiency
47
 Cubic Feet Per
 Minute Per Watt

LIMITED LIFETIME MOTOR WARRANTY



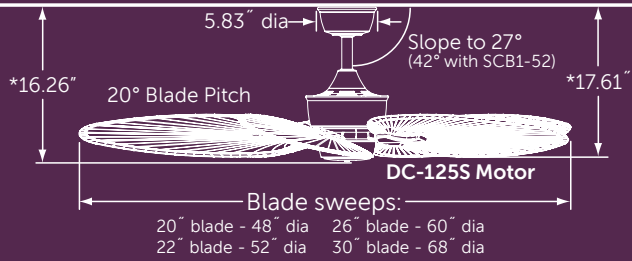

*With included 6" downrod—longer lengths available
Close-to-ceiling kit compatible; *True stainless steel rust resistant downrods available*

Net Hanging Weight: 14.04 lbs.

- ◆ **FAN: MAD3250AB** (1)
antique brass assembly
- BLADES: ISP1** (1)
52" sweep natural palm leaf wide oval
- FITTER: F423AB** (1)
antique brass bowl fitter
- GLASS: G439** (1)
hand-painted parrot bowl



- ◆ **FAN: MAD3250BA** (1)
bronze accent assembly
- BLADES: ISP4** (1)
52" sweep natural palm leaf narrow oval



- ◆ **FAN: MAD3250OB** (1)
oil-rubbed bronze assembly
- BLADES: BPW6090DNA** (1)
60" sweep dark natural accent narrow palm all-weather composite



- ◆ **FAN: MAD3250PW** (1)
pewter assembly
- BLADES: ISD1A** (1)
52" sweep antique woven bamboo wide oval
- FITTER: F423PW** (1)
pewter bowl fitter
- GLASS: G450** (1)
amber glass bowl



For compatible
controls & accessories







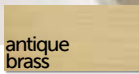
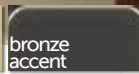
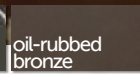

see pages 145 to 158

ISLANDER® DC



FAN: MAD3250OB (1)
oil-rubbed bronze assembly
BLADE SET: ISD4A (1)
antique narrow oval woven bamboo

- 
MAD3250AB
- 
MAD3250BA
- 
MAD3250OB
- 
MAD3250PW

- 
ENERGY SAVINGS
- 
MIX & MATCH
components sold separately
- 
6-SPEED DC
reverse switch on remote
- 
CONTROL
remote
- 
DRY OR DAMP
model specific

INCLUDED:



TR39 remote

ENERGY INFORMATION AT HIGH SPEED:
Airflow measured with BPW6090DNA blades

Airflow
5,020
Cubic Feet Per Minute

Electricity Use
30
Watts (excluding lights)

Airflow Efficiency
153
Cubic Feet Per Minute Per Watt

Energy Star applies to specific blade and motor combinations



LIMITED LIFETIME MOTOR WARRANTY



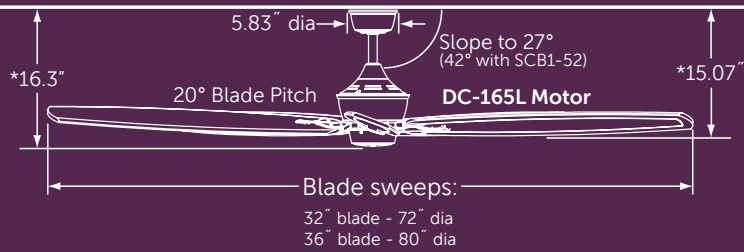

*With included 6" downrod—longer lengths available
Close-to-ceiling kit compatible; *True stainless steel rust resistant downrods available*

Net Hanging Weight: 18.13 lbs.

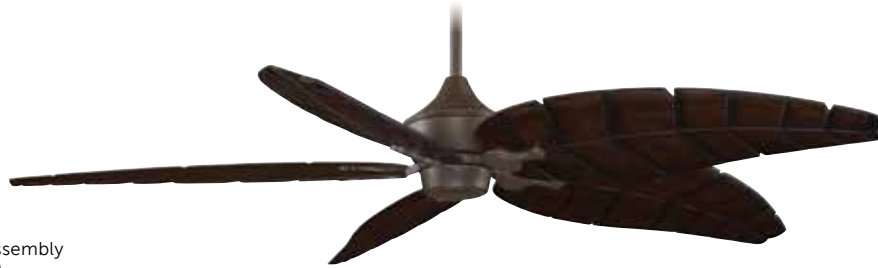

FAN: MAD3252OB (1)
oil-rubbed bronze assembly
BLADES: B5300WA (1)
72" sweep walnut carved wood



FAN: MAD3252BN (1)
brushed nickel assembly
BLADES: B6801DWA (1)
80" sweep dark walnut carved wood



FAN: MAD3252OB (1)
oil-rubbed bronze assembly
BLADES: B6831WA (1)
80" sweep walnut carved wood

For compatible
controls & accessories



see pages 145 to 158

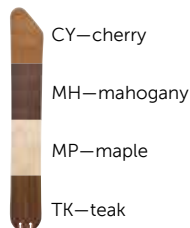

BPW6000**
80" composite



B5300**
72" wood



B6801**
80" wood



B6831WA
80" wood



B6841DWA
80" wood

BIG ISLAND™



FAN: MAD3252BN (1)
brushed nickel assembly
BLADES: BPW6000TK (1)
80" sweep teak composite

brushed nickel
MAD3252BN oil-rubbed bronze
MAD3252OB

- ENERGY SAVINGS
- MIX & MATCH components sold separately
- 6-SPEED DC reverse switch on remote
- CONTROL remote
- DRY OR DAMP model specific

INCLUDED:



TR39 remote

ENERGY INFORMATION AT HIGH SPEED:
Airflow measured with BPW6000** blades

Airflow	Electricity Use	Airflow Efficiency
10,082	32	318
Cubic Feet Per Minute	Watts (excluding lights)	Cubic Feet Per Minute Per Watt





Energy Star applies to specific blade and motor combinations

LIMITED LIFETIME MOTOR WARRANTY

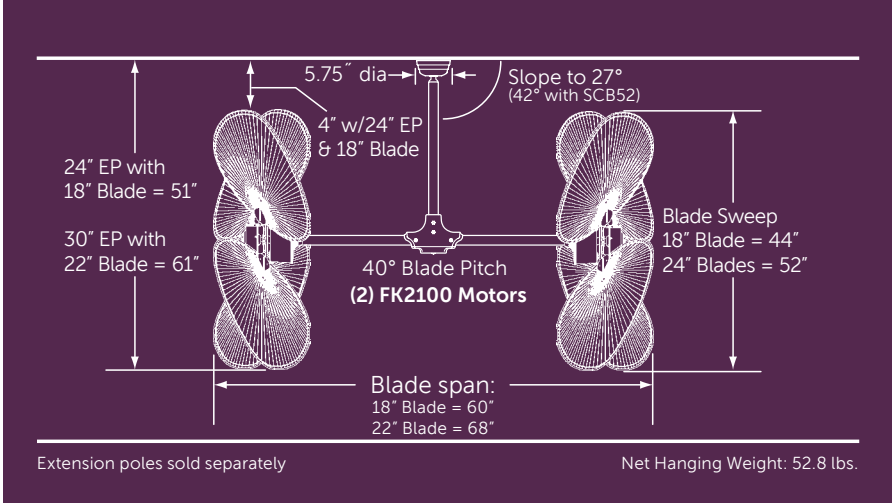



- 
FAN: FP240OB (1)
 oil-rubbed bronze assembly
EXTENSION POLE: EP300B (1)
 30" oil-rubbed bronze
BLADES: PAD1A (1)
 52" sweep antique wide oval woven bamboo

- 
FAN: FP240PW (1)
 pewter assembly
EXTENSION POLE: EP30PW (1)
 30" pewter
BLADES: PAD1C (1)
 52" sweep clear wide oval woven bamboo
ACCESSORY: P48 (1)
 monkey

- 
FAN: FP240RS (1)
 rust assembly
EXTENSION POLE: EP30RS (1)
 30" rust
BLADES: PAD1A (1)
 52" sweep antique wide oval woven bamboo
FILIGREE: FLRS (1)
 rust

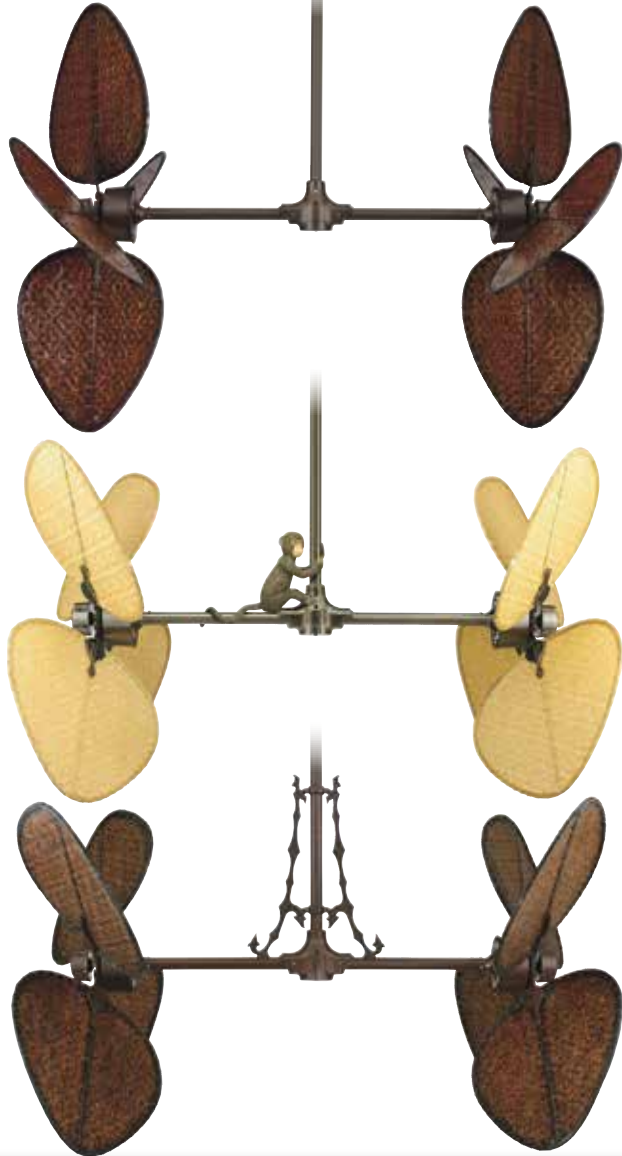

For compatible controls & accessories



see pages 145 to 158

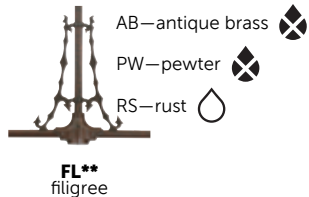

PALISADE®

FAN: FP240OB (1)
oil-rubbed bronze assembly
EXTENSION POLE: EP48OB (1)
48" oil-rubbed bronze
BLADES: B5080CP (1)
52" sweep cairo purple wood

oil-rubbed
bronze
FP240OB

pewter
FP240PW

rust
FP240RS

MIX & MATCH
components
sold separately

2-SPEED AC
reverse switch
on fans

CONTROL
wall

DRY OR DAMP
model specific

INCLUDED:



CW3WH wall control

LIMITED LIFETIME MOTOR WARRANTY



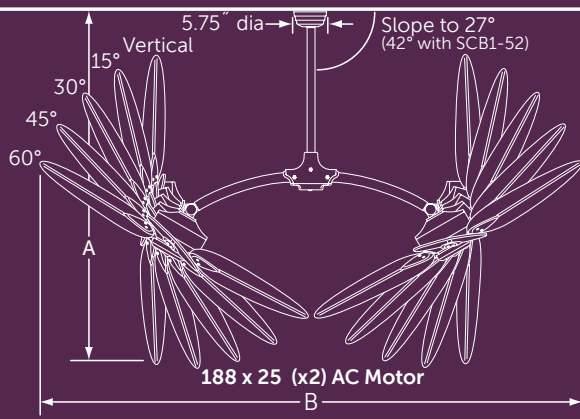

24" downrod included—longer lengths available
 True stainless steel rust resistant downrods available

Net Hanging Weight: 60 lbs.

Motor Tilt Angle	44" Sweep Blades		49" Sweep Blades		52" Sweep Blades	
	Dim. A w/24" DR	Dim. B w/24" DR	Dim. A w/24" DR	Dim. B w/24" DR	Dim. A w/24" DR	Dim. B w/24" DR
Vertical	54.5"	56.5"	56.5"	56.5"	58.5"	56.5"
15°	55.0"	63.5"	58.0"	64.5"	59.0"	65.5"
30°	54.5"	73.0"	56.0"	75.0"	58.0"	77.0"
45°	52.5"	80.5"	54.0"	83.0"	55.0"	86.0"
60°	49.0"	85.0"	50.0"	88.5"	*51.0"	*92.0"

FAN: FP7000OB (1)
 oil-rubbed bronze assembly
 (motor heads at 30°)
BLADES: CABPP4BR (1)
 52" sweep bronze/red all-weather
 composite oval palm

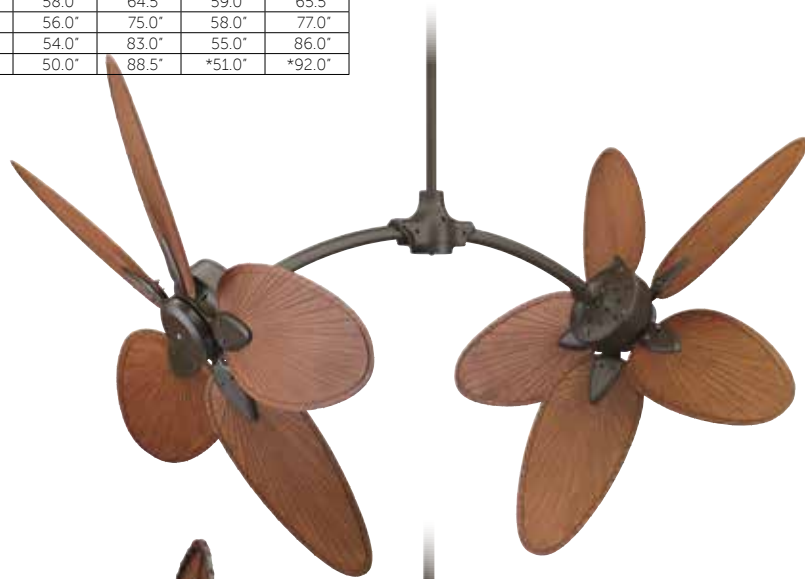

FAN: FP7000OB (1)
 oil-rubbed bronze assembly
 (motor heads vertical)
BLADES: CAISD2A (1)
 44" sweep antique wide
 oval woven bamboo



For compatible
 controls & accessories



see pages 145 to 158



B5213WA
 walnut

CARUSO™

FAN: FP7000OB (1)
oil-rubbed bronze
assembly
BLADES: B5213WA (1)
52" sweep walnut
carved wood

oil-rubbed
bronze
FP7000OB

MIX & MATCH
components
sold separately

2-SPEED AC
reverse switch
on fans

CONTROL
wall

DRY OR DAMP
model specific

INCLUDED:



CW3WH-CA wall control

LIMITED LIFETIME MOTOR WARRANTY



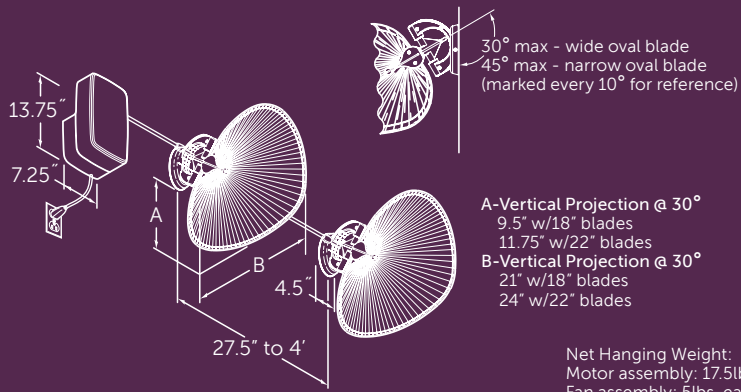

Net Hanging Weight:
Motor assembly: 17.5lbs
Fan assembly: 5lbs. ea.

Not recommended for use in sound sensitive areas.

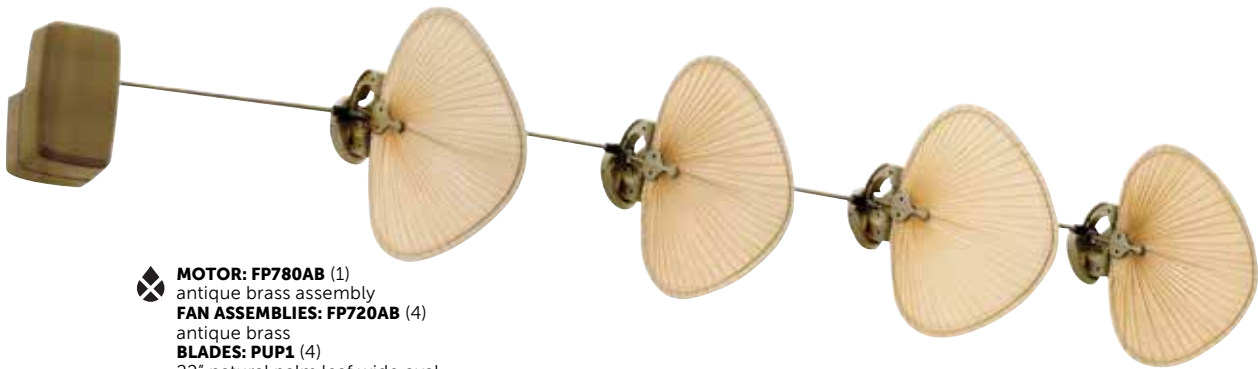

- ❖ **MOTOR: FP780AB** (1)
antique brass assembly
- FAN ASSEMBLIES: FP720AB** (4)
antique brass
- BLADES: PUP1** (4)
22" natural palm leaf wide oval



- ❖ **MOTOR: FP780PW** (1)
pewter assembly
- FAN ASSEMBLIES: FP720PW** (6)
pewter
- BLADES: PUD1A** (6)
22" antique woven bamboo
wide oval

For compatible
controls & accessories



see pages 145 to 158

PUNKAH®

 **MOTOR: FP780PW** (1)
pewter assembly
FAN ASSEMBLIES: FP720PW (5)
pewter
BLADES: PUP1 (5)
22" natural palm leaf wide oval

antique brass	pewter
FP780AB FP720AB	FP780PW FP720PW

POWER CORD
2' cord



MIX & MATCH
components
sold separately

1-SPEED AC
no reverse

DRY OR DAMP
model specific

LIMITED LIFETIME MOTOR WARRANTY

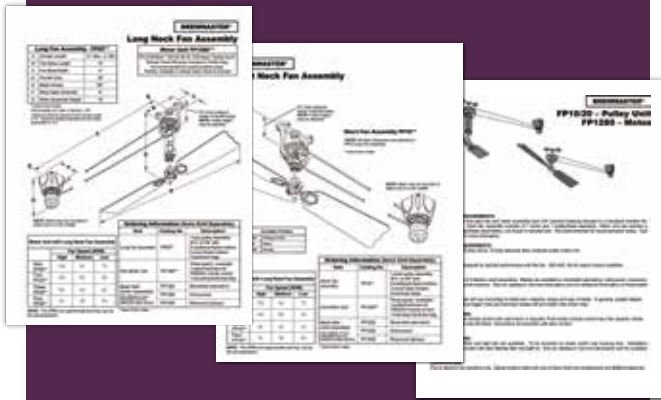



For dimensions and configurations, please see our model-specific specification sheet, available at fanimation.com

Not recommended for use in sound sensitive areas.



The Brewmaster® carries on Fanimation's reputation for reproducing unusual, yet functional, belt-drive fans. These fans were originally produced in the late 1800s by Snediker & Carr®, the premier belt-drive fan manufacturer of their day. Fanimation has adapted this timeless masterpiece to install and operate with more ease and durability.

- Neoprene belting replaces the high-maintenance leather belts.
- Lead and copper babbitt sleeves have given way to sealed ball bearings.
- Hardwood laminate blades that resist warping and splitting replace the temperamental solid wood blades.

The Brewmaster® combines the latest technology with several blade options including the original oversized wood blade design. The Brewmaster® is powered by a gearless direct drive motor, and allows you to operate one or two fans.

- ◆ **MOTOR: FP1280AB** (1)
antique brass assembly
- HEAD: FP10AB** (2)
antique brass short neck assembly
- BLADE SET: BMP1** (2)
50° sweep natural finish wide oval palm

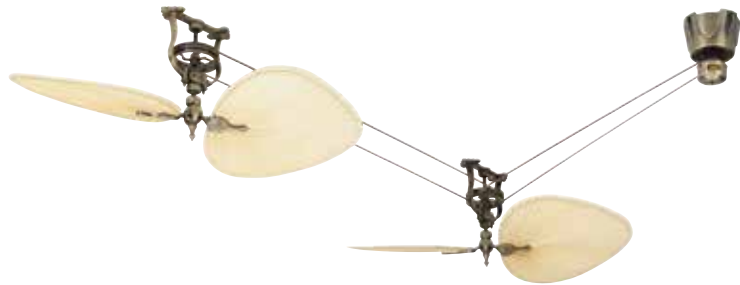

- ◊ **MOTOR: FP1280BL** (1)
black assembly (required but not shown)
- HEAD: FP20BL** (1)
black long neck assembly
- BLADE SET: BMD4A** (1)
50° sweep narrow oval woven bamboo

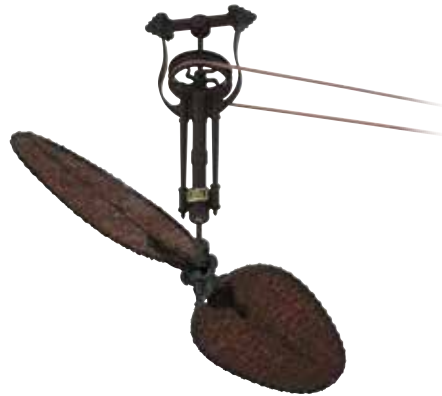

For compatible controls & accessories



see pages 145 to 158



reversible oak/walnut

FP1022
wood



cherry

FP1026
wood



rosewood

FP1030
wood



BREWMASTER™

- ◆ **MOTOR: FP1280BL** (1)
black assembly (required but not shown)
- HEAD: FP20BL** (1)
black long neck assembly
- BLADE SET: FP1026** (1)
25" cherry

antique
brass

FP1280AB
FP10AB
FP20AB

black

FP1280BL
FP10BL
FP20BL

INCLUDED:



TR20WH control



MIX & MATCH
components
sold separately



3-SPEED AC
reverse switch
on remote



CONTROL
remote



DRY OR DAMP
model specific

FAN SPEED (RPM): Fan Assemblies

	High	Medium	Low
One	127	100	82
Two	106	60	46
Three	89	46	35
Four	76	38	28

LIMITED LIFETIME MOTOR WARRANTY







PORTABLES



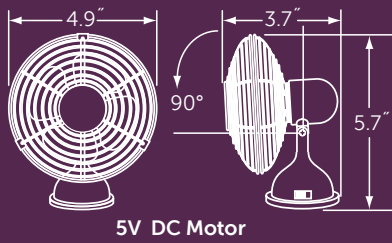

5V DC Motor

Net Weight: 1.1 lbs.

FAN: FP6252BN (1)
brushed nickel assembly with
brushed nickel fan blades and
brushed nickel cage



FAN: FP6252BN (1)
brushed nickel assembly with
brushed nickel fan blades and
brushed nickel cage



FAN: FP6252BN (1)
brushed nickel assembly with
brushed nickel fan blades and
brushed nickel cage



MINI BREEZE™



 **FAN: FP6252BN (1)**
brushed nickel assembly with
brushed nickel blades and
brushed nickel cage

brushed
nickel
brushed
nickel
FP6252BN



USB PLUG



1-SPEED
no reverse



DRY
indoor only

INCLUDED:



USB power cord

LIMITED LIFETIME MOTOR WARRANTY

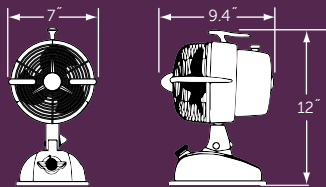

76 x 66 AC Motor

Net Weight: 5.1 lbs.

FAN: FP7958BB (1)
baby blue assembly with chrome accents and black blades



FAN: FP7958MB (1)
mysterious black assembly with chrome accents and black blades



FAN: FP7958MI (1)
milky ivory assembly with chrome accents and black blades



FAN: FP7958RG (1)
rose gold assembly with rose gold accents and black blades



FAN: FP7958SR (1)
spicy red assembly with chrome accents and black blades



FAN: FP7958SS (1)
sonic silver assembly with chrome accents and black blades



URBANJET™



 **FAN: FP7958RG (1)**
rose gold assembly with rose gold accents and black blades

baby blue FP7958BB	mysterious black FP7958MB	milky ivory FP7958MI	rose gold FP7958RG	spicy red FP7958SR	sonic silver FP7958SS
-----------------------	------------------------------	-------------------------	-----------------------	-----------------------	--------------------------



3-SPEED
no reverse



POWER CORD
5.5' cord



CONTROL
rotary



DRY
indoor only

LIMITED LIFETIME MOTOR WARRANTY

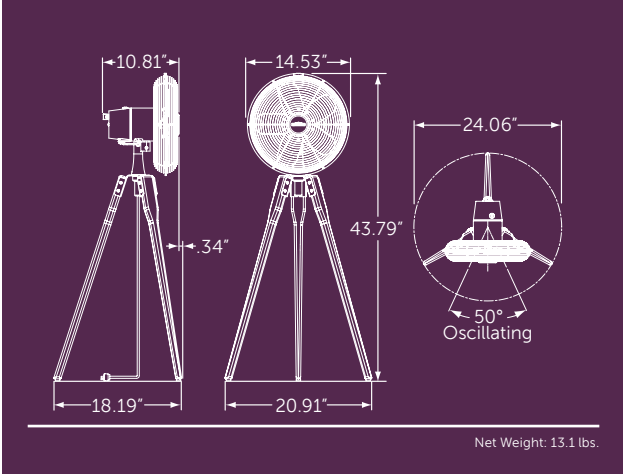

FAN: FP8014OB (1)
oil-rubbed bronze assembly with black blades and walnut finish legs



FAN: FP8014SN (1)
satin nickel assembly with black blades and walnut finish legs



ARDEN™



 **FAN: FP8014SN (1)**
satin nickel assembly with black blades and walnut finish legs

oil-rubbed
bronze

satin
nickel

walnut

walnut

FP8014OB

FP8014SN



3-SPEED
no reverse



POWER CORD
8' cord



CONTROL
rotary



DRY
indoor only

LIMITED LIFETIME MOTOR WARRANTY

For dimensions and configurations, please see our model-specific specification sheet, available at fanimation.com

FAN: FPH210AC (1)
antique copper with black motor assembly
CEILING MOUNT: FPH81BL1 (1)
black ceiling mount—1" dia. x 6" long downrod included



FAN: FPH210BL (1)
black assembly
BASE: FPH21BL (1)
black floor base
COLUMN: FPH70CP (1)
carved post column



FAN: FPH210RS (1)
rust assembly
WALL MOUNT: FPH61RS (1)
rust wall mount



For compatible controls & accessories



see pages 145 to 156

COLUMNS



BL—black

CP—carved post

FPH70**

PEDESTAL MOUNT



FPH21BL
black

WALL MOUNT



FPH61**
black or rust

CEILING MOUNT



use with CW1WH

FPH811**
black or rust



CW1WH
wall control

OLD HAVANA™



 **MOTOR: FPH210RS** (1)
 rust assembly
BASE: FPH21BL (1)
 black pedestal base
COLUMN: FPH70CP (1)
 carved post

antique copper	black	rust
black	black	rust
FPH210AC	FPH210BL	FPH210RS

MIX & MATCH
 components
 sold separately

3-SPEED
 no reverse

POWER CORD
 8' cord

CONTROL
 rotary

DRY OR DAMP
 model specific

LIMITED LIFETIME MOTOR WARRANTY



REMOTE CONTROLS

- Control specifications on page 149
- Control options are not available for Bourbon Street®, Palmetto® and Punkah®

UL LISTED

- Included
- Optional

Do not store or mount remote controls outdoors

WH—White LA—Light Almond



- BTCR9**
- Bluetooth® connectivity
 - Fan and downlight
 - Receiver unit and hand-held transmitter



- BTR9**
- Bluetooth® connectivity
 - Fan and downlight
 - Receiver unit only



- BTT9**
- fanSync™ hand-held remote
 - Non-reversing
 - Fan and downlight



- BTT9R**
- fanSync™ hand-held remote
 - Reversing
 - Fan and downlight



- TR205**
- Hand-held remote
 - Fan and downlight
 - Shutoff timer
 - Home away
 - Fresh air
 - Safe exit



- SW24****
- Palisade® receiver unit
 - Receiver unit only
 - For use with TR24** control



- SW70****
- Caruso™ receiver unit
 - Receiver unit only
 - For use with TR24** control

	BTCR9	BTR9	BTT9	BTT9R	TR205	SW24**	SW70**
Aire Décor®							
Aire Décor® Damp							
Aire Deluxe™							
Ascension™							
Avaston™							
Beckwith™							
Belleria®							
Benito™							
Brewmaster®							
Camhaven™							
Cancun™ Wet							
Cancun™ 42							
Caruso™							
Celano v2™							
Crestford™							
Drone™							
Duplex™							
Edgewood®							
Embrace™							
Enigma®							
Extraordinaire®							
Hugh™ 44 & 52							
Islander® AC							
Islander® DC							
Levon™ AC							
Levon™ Custom							
Levon™ DC							
myFanimation™ Distinction™ AC							
myFanimation™ Distinction™ DC							
Odyn™							
Old Havana®							
Palisade®							
Palma™							
Pickett™							
Pickett™ Drum							
Spitfire™							
Stellar™							
Subtle™							
Torto™							
Torto™ LED							
Ventana™							
Windpointe®							
Xeno™ Damp							
Xeno™ Wet							
Zonix™							
Zonix™ LED							
Zonix™ Wet							

*Must use with SW24 **Must use with SW50** *** Must use with SW70

WALL CONTROLS

- Wall controls include matching face plate
- Control specifications on page 150
- Control options are not available for Bourbon Street®, Palmetto® and Punkah®
- **UL LISTED**

- 🟢 Included
- 🟡 Optional

Do not store or mount wall controls outdoors unless using WP60 waterproof box

WH—White LA—Light Almond



CW1WH & CW1LA
• Fan-only slide control

CW1SWWH & CW1SWLA
• Fan slide control with light toggle switch

CW2WH & CW2LA
• Fan and light slide control

CW3WH
• Fan-only slide control
• CW3**-CA for Caruso™

CW5WH & CW5LA
• Two-fan slide control

CW6WH
• Palisade® fan and light slide control

	CW1WH & CW1LA • Fan-only slide control	CW1SWWH & CW1SWLA • Fan slide control with light toggle switch	CW2WH & CW2LA • Fan and light slide control	CW3WH • Fan-only slide control • CW3**-CA for Caruso™	CW5WH & CW5LA • Two-fan slide control	CW6WH • Palisade® fan and light slide control
Aire Décor®	🟡	🟡	🟡		🟡	
Aire Décor® Damp	🟡	🟡	🟡		🟡	
Aire Deluxe™	🟡		🟡		🟡	
Ascension™						
Avaston™						
Beckwith™						
Belleria®	🟡	🟡	🟡		🟡	
Benito™						
Brewmaster®						
Camhaven™						
Cancun™ Wet	🟡	🟡	🟡		🟡	
Cancun™ 42	🟡	🟡	🟡		🟡	
Caruso™				🟢		🟡
Celano v2™						
Crestford™	🟡	🟡	🟡		🟡	
Drone™						
Duplex™						
Edgewood®	🟡	🟡	🟡		🟡	
Embrace™						
Enigma®						
Extraordinaire®						
Hugh™ 44 & 52						
Islander® AC	🟡	🟡	🟡		🟡	
Islander® DC						
Levon™ AC	🟡	🟡	🟡		🟡	
Levon™ Custom						
Levon™ DC						
myFanimation™ Distinction™ AC						
myFanimation™ Distinction™ DC						
Odyn™						
Old Havana®						
Palisade®				🟢		🟡
Palma™		🟡	🟡			
Pickett™		🟡	🟡			
Pickett™ Drum		🟡	🟡			
Spitfire™						
Stellar™						
Subtle™						
Torto™						
Torto™ LED						
Ventana™						
Windpointe®	🟡	🟡	🟡		🟡	
Xeno™ Damp						
Xeno™ Wet		🟡	🟡			
Zonix™		🟡	🟡		🟡	
Zonix™ LED						
Zonix™ Wet	🟡	🟡	🟡		🟡	

*Must use with SW50**

REMOTE CONTROL SPECIFICATIONS



TR20WH

- Reversible fan and light remote
- Mounts over switch plate
- 3 fan speeds
- Downlight control



TR24WH

- Non-reversible fan and light remote
- Mounts over switch plate
- 3 fan speeds
- Downlight control



TR39

- DC reversible fan and light remote
- Learn-mode for easy set up and 65,000 code settings
- 6 fan speeds
- Downlight control



TR205

- DC reversible fan and light remote
- Mounts over switch plate
- 31 fan speeds
- Downlight control
- 1, 3 and 6 hour timer
- Fresh Air function
- Safe Exit function
- Home Away function



BTT9

- fanSync™ companion remote control
- 3 fan speeds
- Downlight control
- Wall mount for remote



BTT9R

- fanSync™ companion remote control
- 3 fan speeds with reverse
- Downlight control
- Wall mount for remote



C4

- Non-reversing fan and light remote
- Learn-mode canopy receiver unit for easy set up and 65,000 code settings included
- 3 fan speeds
- 1.25 amps max. fan load
- Infinite light levels up to 250 watts



CH1WH & CH1LA

- Old Havana® fan remote
- mounts over switch plate
- 3 fan speeds



CRL4WH

- Non-reversing fan and light remote
- Learn-mode canopy receiver unit for easy set up and 65,000 code settings included
- 3 fan speeds
- 1.25 amps max. fan load
- Infinite light levels up to 190 watts
- Dimmer on/off switch for use with CFL bulbs (dimmer must be turned off)
- May be used with CWRL4**



CRL8TS

- Non-reversing touch-screen fan and light remote
- Learn-mode canopy receiver unit for easy set up and 65,000 code settings included
- 3 fan speeds
- Fan timer delay feature
- Delay light feature
- 1.0 amps max. fan load
- Infinite light levels up to 190 watts
- Dimmer on/off switch for use with CFL bulbs (dimmer must be turned off)



RC110WH

- Extraordinaire® non-reversing fan remote
- mounts over switch plate
- 3 fan speeds

WALL CONTROL SPECIFICATIONS



WH—White



LA—Light Almond



C21

- Reversible fan and light control
- 2-wire installation
- 3 fan speeds
- infinite light levels



C23

- Reversible fan and light control
- 2-wire installation
- 3 fan speeds
- infinite light levels for uplight and downlight



C25

- Non-reversing fan and light control
- battery operated
- 3 fan speeds
- infinite light levels



CW1WH & CW1LA

- Fan-only slide control
- 2-wire installation
- 3 fan speeds
- 1.25 amps max. fan load



CW1SWWH & CW1SWLA

- Fan slide control with light on/off toggle switch
- 3-wire installation
- 3 fan speeds
- 1.25 amps max. fan load



CW2WH & CW2LA

- Fan and light slide control
- 3-position light levels
- 3-wire installation
- 3 fan speeds
- 1.25 amps max. fan load



CW3WH

- Palisade® and Caruso™ fan-only slide control
- CW3*-CA for Caruso™
- 2-wire installation
- 2 fan speeds
- 5 amps max. fan load



CW5WH & CW5LA

- Fan-only two fan slide control
- 2-wire installation
- 3 fan speeds
- 5 amps max. fan load



CW6WH

- Palisade® fan and light control
- 3-position light levels
- 3-wire installation
- 2 fan speeds



CW7WH

- Fan-only five fan slide control
- 2-wire installation
- 3 fan speeds
- 5 amps max. fan load



CW40

- Fan-only slide control
- 2-wire installation
- 4 fan speeds
- 1.25 amps max. fan load



CW60WH

- Fan and light control
- 3-wire installation
- Infinite light levels
- 3 fan speeds
- 1.25 amps max. fan load
- Wet rated when used with WP60—this page



CW110WH

- Extraordinaire® fan-only slide control
- 2-wire installation
- 3 fan speeds
- 1.25 amps max. fan load



CWRL4WH & CWRL4LA

- Non-reversing fan and light control
- 2-wire installation
- 3 fan speeds
- 1.0 amps max. fan load
- Learn-mode canopy receiver unit for easy set up and 65,000 code settings included
- Infinite light levels up to 190 watts
- Dimmer on/off switch for use with CFL bulbs (dimmer must be turned off)
- May be used with CRL4WH



TW40WH & TW40LA

- DC reversible fan and light wall control
- Learn-mode for easy set up and 65,000 code settings
- Includes switch plate
- 6 fan speeds
- Downlight control



TW206

- DC reversible fan and light control
- mounts over switch plate
- 31 fan speeds
- Downlight control
- 1, 3 and 6 hour timer
- Fresh Air function
- Safe Exit function
- Home Away function



WP60

- Outdoor control box
- Designed for use with CW60 wall control.
- Fits decora style controls
- Includes gasket.
- 5.3" (L) x 3.9" (W) x 4.8" (H)

CONTROL ACCESSORY



CONTROL YOUR CEILING FAN WITH YOUR SMART DEVICES!



BTCR9

- fanSync™ Bluetooth® receiver & companion remote control
- 3 fan speeds
- Downlight control
- Timer, safe exit and favorites list via smart device
- Wall mount for remote



BTT9

- fanSync™ companion remote control
- 3 fan speeds
- Downlight control
- Wall mount for remote



BTT9R

- fanSync™ companion remote control
- 3 fan speeds with reverse
- Downlight control
- Wall mount for remote



BTR9

- fanSync™ Bluetooth® receiver
- Controls fan and light via smart device
- 3 fan speeds
- Downlight control
- Timer, safe exit and favorites list via smart device
- Wall mount for remote

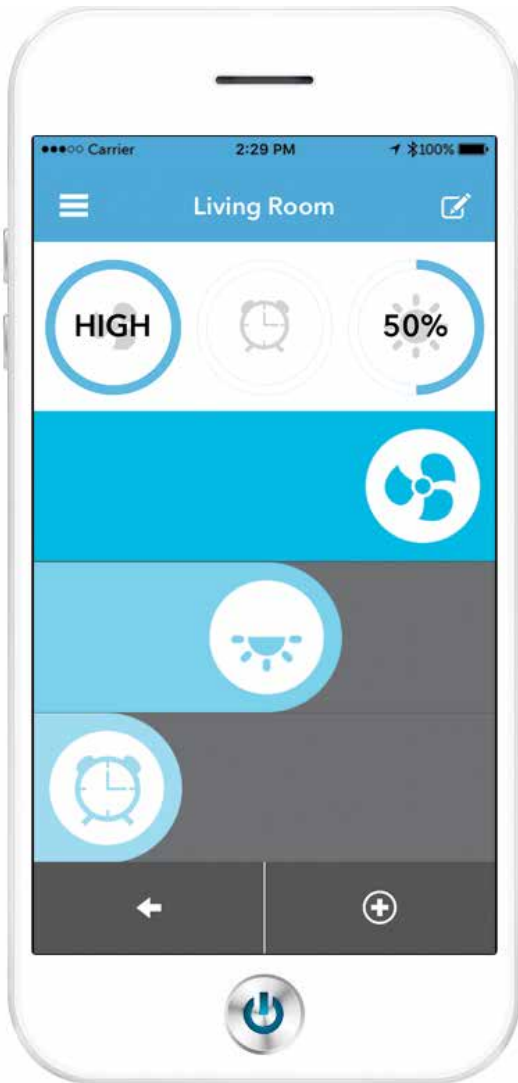

1 Visit www.fanimation.com/fansync to check your fan and device compatibility. fanSync is universal and works with most brands of **3-speed AC ceiling fans**.

2 Easily wire and install the fanSync receiver into your ceiling fan's hanger bracket/canopy.

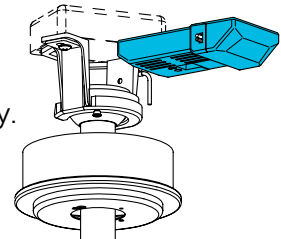

3 Download the fanSync app to your smart device from Google Play or the App Store.

4 Easily find and set up your fan(s) in the fanSync app.



5 Explore and enjoy the many features of the fanSync app!



Fan Speed



Light Dimming



Timer



Safe Exit



Favorites List

BULB REFERENCE

- Fans that include a light kit list the light source under the light kit feature icon on the fan page
- Understanding lumens, correlated color temperature and color rendering index values will help you understand what light output to expect from each fan

LUMENS VERSUS WATTS

In years past, consumers used wattage to rate the brightness of a lamp. However, wattage is a measure of energy use and is not an accurate indicator of lamp brightness. Energy efficient light sources such as LEDs and Compact Fluorescent Lamps (CFL) have much lower wattages while still producing a great amount of light. While wattage measures energy use, lumens measure light output—luminous flux. When determining light output, it is best to compare lumens.

WHAT IS CORRELATED COLOR TEMPERATURE?

Color appearance, also known as Correlated Color Temperature (CCT), is a measure of how warm or cool a light source appears to the human eye. It is measured in degrees Kelvin. The majority of light sources have a Kelvin temperature within the range of 2700K to 6500K. For reference, noon-time daylight has a Kelvin temperature of 5000K. Incandescent light sources generally range from 2700-3500K. Compact Fluorescents and LEDs can range from 2700-6500K. The lower the Kelvin temperature, the warmer the light source appears and the higher the Kelvin temperature, the cooler the light source appears.

WARM WHITE	2700K
SOFT WHITE	3000K
NEUTRAL	3500K
COOL	4100K
SOFT DAYLIGHT	5000K
DAYLIGHT	6500K

WHAT IS THE COLOR RENDERING INDEX?

CRI is the ability of a light source to light up objects of different colors and properly display the colors without influence or making the color look adjusted. CRI is represented by a number on a scale from 0 to 100 with 100 being best. The lower the number, the more distorted a color will look under the light source.

EXAMPLES OF BULB BASES AND TYPES

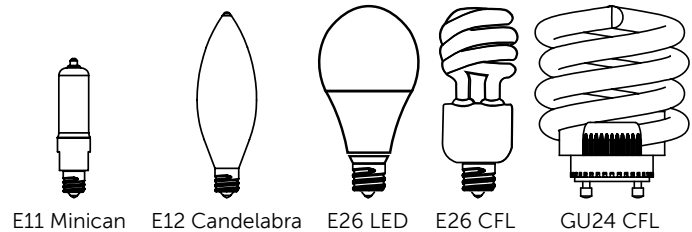

Bulb Base	Bulb Type	Watts	Lumens per Bulb	Correlated Color Temperature (CCT)	Color Rendering Index (CRI)
E11	Minican Halogen Frosted	50	500	2,800	100
E11	Minican Halogen Frosted	75	1,031	2,800	100
E11	Minican Halogen Clear	100	1,600	2,800	100
E12	Candelabra Incandescent Frosted	40	340	2,800	100
E12	Candelabra Incandescent Clear	40	358	2,800	100
E12	Candelabra Halogen (B10)	43	342	2,800	100
E12	Candelabra Incandescent Frosted	60	510	2,800	100
E12	Candelabra Incandescent Clear	60	560	2,800	100
E26	Compact Fluorescent (CFL)	13	959	2,700	80
E26	Compact Fluorescent (CFL)	23	1,600	2,700	80
E26	10W LED	10	800	2,700	90
GU24	Compact Fluorescent (CFL)	13	900	2,700	80
GU24	Compact Fluorescent (CFL)	26	1,600	2,700	80
Connector Pin	16W LED Module	16	1,350	3,000	80
Connector Pin	18W LED Module	18	1,350	3,000	80

LIGHT KITS

- Light kits are for use with most Fanimation fans
- Light bulb requirements vary and are listed for each light kit
- Pull-chain light kits come with chain and fob
- Light bulbs included
- **UL LISTED**



❖ LK113WH white fabric drum lamp shade

- 6.9" (H) x 14" (W)
- Three 50W halogen minican bulbs included
- Lumens: 1,500
- Color Temp: 2,750
- CRI: 99.7



◊ LK114AOB oil-rubbed bronze

- low-profile light kit
- opal frosted glass
- pull chain operation
- 4.8" (H) x 14" (W)
- Three 50W halogen minican bulb included
- Lumens: 1,500
- Color Temp: 2,750
- CRI: 99



◊ LK250 white frosted 13" bowl light kit

- 8" (H) x 13" (W)
- Three 50W halogen minican bulbs included
- Lumens: 1,500
- Color Temp: 2,750
- CRI: 99



◊ LK260 amber frosted 13" bowl light kit

- 8" (H) x 13" (W)
- Three 50W halogen minican bulbs included
- Lumens: 1,500
- Color Temp: 2,750
- CRI: 99



◊ LKLP101OB oil-rubbed bronze

- low-profile light kit
- opal frosted glass
- pull chain operation
- 5.2" (H) x 8.5" (W)
- One 100W halogen minican bulb included
- Lumens: 1,600
- Color Temp: 2,800
- CRI: 99



◊ LKLP102OB oil-rubbed bronze

- low-profile light kit
- opal frosted glass
- pull chain operation
- 5.2" (H) x 8" (W)
- One 100W halogen minican bulb included
- Lumens: 1,600
- Color Temp: 2,800
- CRI: 99



◊ LKLP111AOB oil-rubbed bronze

- low-profile light kit
- amber linen glass
- pull chain operation
- 5.2" (H) x 8.5" (W)
- One 100W halogen minican bulb included
- Lumens: 1,600
- Color Temp: 2,800
- CRI: 99



◊ LKLP111WWH oil-rubbed bronze

- low-profile light kit
- white linen glass
- pull chain operation
- 5.2" (H) x 8.5" (W)
- One 100W halogen minican bulb included
- Lumens: 1,600
- Color Temp: 2,800
- CRI: 99



◊ LKLP112AOB oil-rubbed bronze

- low-profile light kit
- amber linen glass
- pull chain operation
- 5.2" (H) x 8.5" (W)
- One 100W halogen minican bulb included
- Lumens: 1,600
- Color Temp: 2,800
- CRI: 99



◊ LKLP112WSN satin nickel

- low-profile light kit
- white linen glass
- pull chain operation
- 5.2" (H) x 8.5" (W)
- One 100W halogen minican bulb included
- Lumens: 1,600
- Color Temp: 2,800
- CRI: 99

FITTERS, SHADES & DECORATIVE GLASS

- Bowl fitters are for use with most Fanimation fans
- Fitter glass sold separately below
- Glass bowls—12.75" diameter x 4.75" height (G210 and G400 series) require fitters F423 and FW423
- Small glass and shades (G200 series) for use with myFanimation F4 fitter only—page 63
- Finishes and light bulb requirements vary and are listed for each
- Glass and shades should be ordered based on the fitter model selected
- Light bulbs included

UL LISTED



- ◆ F423AB antique brass
- F423MW matte white
- F423OB oil-rubbed bronze
- ◆ F423PW pewter
- F423RS rust
- F423WH white

- 6" (H) x 6" (W)
- Three 50W halogen minican bulbs included
- Lumens: 1,500
- Color Temp: 2,750
- CRI: 99



- ◆ FW423AZ aged bronze
- ◆ FW423OB oil-rubbed bronze
- ◆ FW423RS shown in rust
- ◆ FW423TS tortoise shell
- ◆ FW423WH white

- Uses glass bowls only, sold separately below
- 7" (H) x 13" (W)
- Three 60W candelabra bulbs included
- Lumens: 1,530
- Color Temp: 2,700
- CRI: 99.7



G210
Tropical bowl



G439
Hand-painted parrot



G450
Amber



G451
Powdered amber



G456
White frost

ADDITIONAL *my* FANIMATION GLASS



G100C
Clear ribbed



G100F
White frosted ribbed



G235
Tropical etched glass



G239
Hand-painted parrot



G244
Aged bronze/amber shade



G250
Amber



G256
White frost

DOWNRODS & ACCESSORIES

DOWNRODS

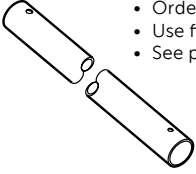

- Order according to length
- Use finish code to complete the part number
- See page 3 for suggested lengths

STEEL

- *DR1-6OB 6" downrod
- DR1-12** 12" downrod
- DR1-18** 18" downrod
- DR1-24** 24" downrod
- DR1-36** 36" downrod
- DR1-48** 48" downrod
- DR1-60** 60" downrod
- DR1-72** 72" downrod

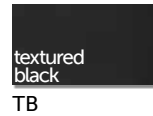
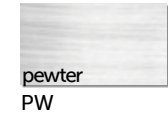
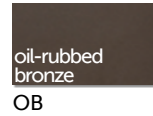
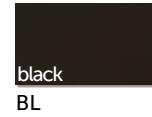
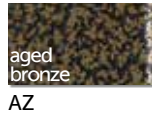

STAINLESS STEEL

- DR1SS-12*** 12" wet downrod
- DR1SS-18*** 18" wet downrod
- DR1SS-24*** 24" wet downrod
- DR1SS-36*** 36" wet downrod
- DR1SS-48*** 48" wet downrod
- DR1SS-60*** 60" wet downrod
- DR1SS-72*** 72" wet downrod

TRUE STAINLESS STEEL DOWNROD.
Wet location rated. Resistant to rust and corrosion.

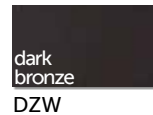
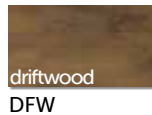

DOWNROD COUPLERS



- Joins two downrods together for extended lengths
- When ordering, use finish code for steel downrods shown above to complete the part number.

DR1-CP** 1" diameter downrod coupler

CLOSE-TO-CEILING KIT



- Replaces hanger bracket/downrod assembly to move your fan closer to the ceiling, creating more head room
- Intended for use with low ceilings.
- Please see individual fan pages for compatibility
- Tall dimensions: 5.13" (H) x 8" (DIA.)
- Short dimensions: 2.67" (H) x 8" (DIA.)

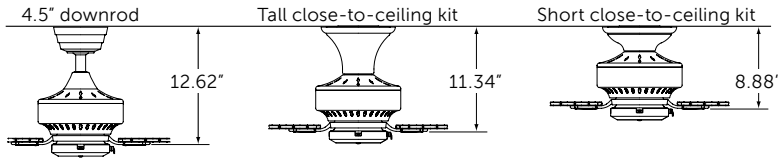

STANDARD

CCK8002AB	antique brass	CCK8002MW	matte white
CCK8002AZ	aged bronze	CCK8002OB	oil-rubbed bronze
CCK8002BA	bronze accent	CCK8002PN	polished nickel
CCK8002BL	black	CCK8002PW	pewter
CCK8002BN	brushed nickel	CCK8002RS	rust
CCK8002CH	chrome	CCK8002SN	satin nickel
CCK8002DCP	dark copper penny	CCK8002TS	tortoise shell
CCK8002DZ	dark bronze	CCK8002WH	white

WET RATED

CCK8002ABW	antique brass	CCK8002MWW	matte white wet
CCK8002AZW	aged bronze	CCK8002OBW	oil-rubbed bronze wet
CCK8002BNW	brushed nickel wet	CCK8002MWW	pewter wet
CCK8002BSW	brushed satin brass wet	CCK8002RSW	rust wet
CCK8002DCPW	dark copper penny wet	CCK8002SNW	satin nickel wet
CCK8002DFW	driftwood wet	CCK8002TBW	textured black wet
CCK8002DZW	dark bronze wet	CCK8002TSW	tortoise shell wet
CCK8002GRW	matte greige wet	CCK8002WHW	white wet
CCK8002MGW	metro gray wet		

EXTENSION POLES

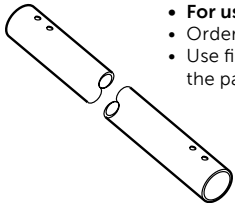

- For use with Palisade® only
- Order according to length
- Use finish code to complete the part number

EP24**	24" downrod
EP30**	30" downrod
EP36**	36" downrod
EP48**	48" downrod
EP60**	60" downrod
EP72**	72" downrod

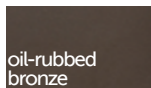

oil-rubbed
bronze
OB



pewter
PW

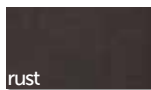

rust
RS

SLOPED CEILING BALL KIT



- Includes black hanger ball only
- For use with Fanimation fans purchased after June 2004
- See individual fan pages for compatibility with your fan
- Hanger ball works with current Fanimation canopy and hanger bracket
- Allows for ceiling slope up to 42°
- For use with any length downrod

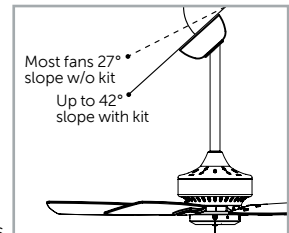

SLOPED CEILING KIT



- Includes hanger bracket, hanger ball, ceiling canopy, canopy screw cover and mounting hardware
- For use with Aire Décor®, Benito™ and Edgewood® series fans
- Allows for ceiling slope up to 42°
- For use with any length downrod

SCK1-52AZ	aged bronze	SCK1-52MW	matte white
SCK1-52BL	black	SCK1-52OB	oil-rubbed bronze
SCK1-52BN	brushed nickel	SCK1-52PN	polished nickel
SCK1-52BS	brushed satin brass	SCK1-52PW	pewter
SCK1-52DF	driftwood	SCK1-52SN	satin nickel
SCK1-52DZ	dark bronze	SCK1-52TS	tortoise shell
SCK1-52GR	matte greige	SCK1-52WH	white

EXTENSION POLE COUPLERS



- For use with Palisade® only
- Joins two extension poles together for extended lengths
- Use finish code to complete the part number.

EPCP** Extension pole coupler

DOWNROD SLEEVE



- Tropical downrod sleeve
- 16" tall
- Requires minimum 24" downrod or extension pole

DRS24TR Downrod sleeve

BLADES

- Blades listed come in sets of five (5) except those for Punkah®—one (1), Brewmaster®—two (2), Palisade®—eight (8), Palmetto—three (3) and Caruso™—ten (10).
- Blades should be ordered based on the fan model selected
- Blade sets vary based on catalog number and are specific to fan models
- Some blade catalog numbers require fan finish codes
- Due to the nature of the materials and the hand-crafted processes; stain, color, texture and shading will vary



Belleria®	ISP1		ISP4		B5280WA	B6080WA	
Bourbon Street®	ISP1		ISP4	FP1018	B5280WA	B6080WA	
Brewmaster®	BMP1						
Caruso™			CAISP4				
Islander® AC	ISP1		ISP4		B5280WA	B6080WA	
Islander® DC	ISP1		ISP4		B5280WA	B6080WA	
Palisade®	PAP1						
Palmetto®		PMP2**					
Punkah®	PUP1						
Windpointe® Custom	ISP1		ISP4		B5280WA	B6080WA	



Belleria®	ISD1A			ISD4A	BPD1A	BPD4A	BPD4MW
Bourbon Street®	ISD1A			ISD4A	BPD1A	BPD4A	BPD4MW
Brewmaster®				BMD4A			
Caruso™			CAISD2A	CAISD4A		CABPD4A	
Islander® AC	ISD1A			ISD4A	BPD1A	BPD4A	BPD4MW
Islander® DC	ISD1A			ISD4A	BPD1A	BPD4A	BPD4MW
Palisade®	PAD1A	PAD1C	PAD2A				
Palmetto®			PMD2A**				
Punkah®	PUD1A	PUD1C					
Windpointe® Custom	ISD1A			ISD4A	BPD1A	BPD4A	BPD4MW

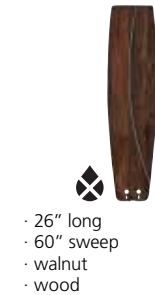
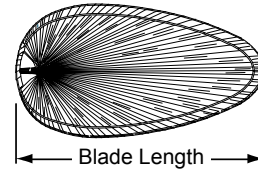
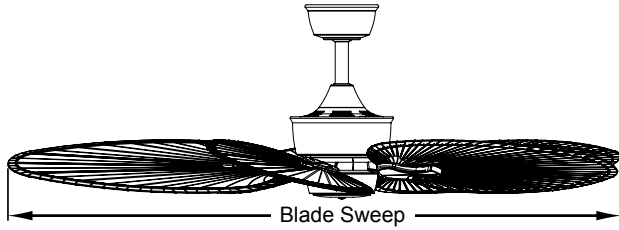

	B5340WA	B5350WA	B5330WA	B6130WA		B5133TKMH	B6133TKMH
	B5340WA	B5350WA	B5330WA	B6130WA		B5133TKMH	B6133TKMH
					B5213WA		
	B5340WA	B5350WA	B5330WA	B6130WA		B5133TKMH	B6133TKMH
	B5340WA	B5350WA	B5330WA	B6130WA		B5133TKMH	B6133TKMH
					B5213WA		
	B5340WA	B5350WA	B5330WA	B6130WA		B5133TKMH	B6133TKMH



	BPP1TN	BPP4TN	BPP1BR	BPP4BR	BPW20CY	BPW24MW	BPW6090DNA	BPW6030MH	BPW6030TK
	BPP1TN	BPP4TN	BPP1BR	BPP4BR	BPW20CY	BPW24MW	BPW6090DNA	BPW6030MH	BPW6030TK
		CABPP4TN		CABPP4BR					
	BPP1TN	BPP4TN	BPP1BR	BPP4BR	BPW20CY	BPW24MW	BPW6090DNA	BPW6030MH	BPW6030TK
	BPP1TN	BPP4TN	BPP1BR	BPP4BR	BPW20CY	BPW24MW	BPW6090DNA		
	BPP1TN	BPP4TN	BPP1BR	BPP4BR	BPW20CY	BPW24MW	BPW6090DNA	BPW6030MH	BPW6030TK

ANTIQUe FAN MUSEUM

presented by the Antique Fan Collectors Association



PASSION, HERITAGE & PRESERVATION

Led by our Founder and CEO, Tom Frampton, Fanimation is dedicated to preserving the history of fans and the fan industry. For years, Tom has been an avid antique fan collector and member of the Antique Fan Collectors Association (AFCA). The AFCA membership has operated a museum since 1997, displaying fans on loan by the membership; this museum was in Wichita, Kansas up until 2008, when the need to relocate the museum arose. Answering the call to preserve viewing of the one-of-a-kind collection, Fanimation made the offer to house the museum at its facility in Zionsville. The move and set-up took nearly a year and the museum saw its reopening July 23, 2009. Since that time, the museum has grown and continues to grow, housing over a thousand antique fans on two floors. Tom's own unique collection of fans is a part of the museum collection along with over 500 antique advertising style hand fans and other fan memorabilia.





LOCATION

10983 Bennett Parkway
Zionsville, IN 46077



HOURS

Monday thru Friday 10 am - 4 pm
Or call for an appointment, 317-733-4113



MUSEUM HIGHLIGHTS

- The AFCA museum contains more than 1,000 antique ceiling, desk and hand fans with over 140 manufacturers represented
- The oldest electric desk fan in the museum dates from the early 1890's
- The oldest non-electric fans (steam, belt & pulley or water powered) date from the early 1880's.
- It is the only antique fan museum open to the public in the world
- The AFCA has approximately 700 members worldwide
- The museum contains some of the earliest battery-powered fans, water-powered fans, wind-up fans, electric hand-held fans, ceiling fans, wall fans, desk fans, pedestal fans, rail-car fans and fans that don't even look like fans.
- The museum contains hundreds of hand-held fans that feature advertising from manufactures, retailers, politicians and movie stars.



INDEX

FANS	PAGE
A1**	57, 58, 62
BP200**1	105, 106
BP210**1	105, 106
BP215OB1	105, 106
BP220**1	105, 106
BP225OB1	105, 106
BP230**1	105, 106
C1**	57, 58, 62
D1**	59, 62, 64
FP10**	133, 134
FP1280**	133, 134
FP20**	133, 134
FP2120MG	89, 90
FP240**	127, 128
FP320**1	121, 122
FP4320**1	115, 116
FP4620**	19, 20
FP4630SN	19, 20
FP4640**	73, 74
FP4650**	75, 76
FP510**	47, 48
FP520**	47, 48
FP540**	47, 48
FP580**	47, 48
FP601**	47, 48
FP602**	47, 48
FP603**	47, 48
FP604**	47, 48
FP605**	47, 48
FP6210**	95, 96
FP6244**	35, 36
FP6245B**	35, 36
FP6252BN	137, 138
FP6258BNMW	119, 120
FP6260****	99, 100
FP6284**	37, 38
FP6285B**	37, 38
FP6717**	67, 68
FP6728**	69, 70
FP6729***	71, 72
FP7000OB	129, 130
FP720**	131, 132
FP7500**	111, 112
FP780**	131, 132
FP7900**	87, 88
FP7902BN	91, 92
FP7910**	23, 24
FP7954OB	103, 104
FP7958**	139, 140

FANS	PAGE
FP7963RS	101, 102
FP7964**	17, 18
FP7996****	97, 98
FP8003**	27, 28
FP8012**	117, 118
FP8014**	141, 142
FP8016OB	117, 118
FP8032DZ	31, 32
FP8042**	39, 40
FP8095**	33, 34
FPD6235**	55, 56
FPD6236**	79, 80
FPD6254**	15, 16
FPD7916**	81, 82
FPD8149***	85, 86
FPH210**	143, 144
FPH21BL	143, 144
FPH61**	143
FPH70**	143, 144
FPH81**1	143
FPS7955**	13, 14
FPS7981**	11, 12
FPS8332**	51, 52
FPS8355**	53, 54
HA7966**	45, 46
MA6721**	85, 86
MA7500**	113, 114
MA7966**	45, 46
MAD3250**	123, 124
MAD3252**	125, 126
MAD7912**	83, 84
MAD7993**	87, 88
OF110**	65, 66
PL8274**	25, 26
TF610**	39, 40
TF710**	41, 42
TF721**	43, 44
TF910**	107, 108
TF971**	109, 110

LIGHT KITS	PAGE
LK113WH	153
LK114AOB	153
LK250	153
LK260	153
LK4640**	73
LK6721**	77, 78
LK7912**	83, 84
LKLP101OB	153

LIGHT KITS	PAGE
LKLP102OB	113, 153
LKLP111AOB	153
LKLP111WWH	153
LKLP112AOB	153
LKLP112WSN	153

FITTERS	PAGE
F1**	59, 63
F2**	57, 58, 59, 63, 64
F3**	57, 63
F4**	57, 59, 63
F423**	123, 154
FW423**	154

GLASS & SHADES	PAGE
G1**	57, 59, 63
G100*	154
G2**	58, 59, 63
G210	154
G235	154
G239	154
G244	154
G250	154
G256	154
G3**	57, 63, 64
G4**	59, 63
G439	123, 154
G450	123, 154
G451	154
G456	154
G5**	57, 63
G6**	63

BLADES	PAGE
B154**	59, 62
B160**	62
B172**	57, 62, 64
B254**	57, 62
B260**	59, 62
B272**	62
B354**	62
B360**	59, 62
B372**	62
B4400SN	19, 57
B4442SN	19, 57
B454**	62
B460**	57, 62
B472**	62
B5080**	127, 128

BLADES	PAGE	BLADES	PAGE	CONTROLS	PAGE
B5133TKMH.....	121, 158	FP1026.....	133, 134	TW206.....	148, 150
B5213WA.....	127, 129, 158	FP1030.....	133	TW40**.....	148, 150
B5280WA.....	113, 157	ISD1A.....	113, 121, 123, 157	WP60.....	73, 150
B5300WA.....	125	ISD4A.....	124, 157		
B5330WA.....	158	ISP1.....	121, 122, 123, 157	ACCESSORIES	PAGE
B5340WA.....	113, 115, 158	ISP4.....	123, 157	CCK8002**.....	113, 156
B5350WA.....	158	PAD1A.....	127, 157	CCK8002**W.....	156
B554**.....	62	PAD1C.....	127, 157	DR1-12**.....	155
B560**.....	57, 62	PAD2A.....	157	DR1-12**W.....	155
B6080WA.....	157	PAP1.....	157	DR1-18**.....	155
B6130WA.....	158	PMD2AAB.....	48, 157	DR1-18**W.....	155
B6133TKMH.....	158	PMD2ABL.....	157	DR1-24**.....	155
B654**.....	58, 59, 62	PMP2AB.....	157	DR1-24**W.....	155
B660**.....	62	PMP2BL.....	157	DR1-36**.....	155
B6720**.....	77, 78	PUD1A.....	131, 157	DR1-36**W.....	155
B6801**.....	125	PUD1C.....	157	DR1-48**.....	155
B6831WA.....	125	PUP1.....	131, 132, 157	DR1-48**W.....	155
B6841DWA.....	125			DR1-60**.....	155
B754DWA.....	57, 62	CONTROLS	PAGE	DR1-60**W.....	155
B760DWA.....	62	BTCR9.....	145, 151	DR1-6OB.....	155
B7912**.....	83	BTR9.....	145, 151	DR1-72**.....	155
B7913**.....	83, 84	BTT9.....	145, 151	DR1-72**W.....	155
B7914**.....	83	C21.....	148, 150	DR1-CP**.....	155
B7966**.....	45, 46	C23.....	150	DRS24TR.....	156
B7993-84**.....	87, 88	C25.....	148, 150	EP24**.....	156
B854**.....	62	C4.....	146, 149	EP30**.....	156
B860**.....	59, 62	CH1**.....	146, 149	EP36**.....	156
BEW42WALW.....	39, 41	CRL4**.....	146, 149	EP48**.....	156
BMD4A.....	133, 157	CRL8TS.....	146, 149	EP60**.....	156
BMP1.....	133, 157	CW1**.....	147, 150	EP72**.....	156
BPD1A.....	157	CW110WH.....	148, 150	EPCP**.....	156
BPD4**.....	115, 157	CW1SW**.....	147, 150	ET6235-***.....	55
BPP1**.....	158	CW2**.....	150, 147	FL**.....	127
BPP4**.....	115, 158	CW3WH.....	150, 147	P48.....	127
BPW20CY.....	113, 158	CW3WH-CA.....	150, 147	SCB1-52.....	156
BPW24MW.....	158	CW5**.....	150, 147	SCK1-52**.....	156
BPW4426**.....	19, 73, 75	CW60WH.....	148, 150		
BPW4442**.....	19, 73, 75	CW6WH.....	147, 150		
BPW6000**.....	125, 126	CW7WH.....	148, 150		
BPW6030**.....	158	CWRL4**.....	148, 150		
BPW6090DNA.....	113, 114, 116, 123, 158	RC110WH.....	145, 149		
BPW7912**.....	83	SW24**.....	145		
CABPD4A.....	157	SW70OB.....	145		
CABPP4**.....	129, 157	TR205.....	145, 149		
CAISD2A.....	129, 157	TR20WH.....	146, 149		
CAISD4A.....	157	TR24WH.....	146, 149		
CAISP4.....	157	TR33WH.....	46		
FP1018.....	47, 157	TR39.....	149		
FP1022.....	133	TR400.....	100		

 **FANIMATION**[®]
C E I L I N G F A N S

 888.567.2055

 FANIMATION.COM

 fanimation

 fanimation

 fanimationfans

 fanimationfan

 10983 Bennett Parkway, Zionsville, Indiana 46077



LTFC0117
JANUARY 2017