

FALCON

W Series

Medium Duty, Grade 2 Cylindrical Lever and Knob Locks



THE FALCON DIFFERENCE

S E C U R I T Y A N D U N C O M P R O M I S I N G V A L U E

At Falcon, we know that every product you specify not only has to meet local building codes, but also your expectations for performance and quality. We take your expectations seriously, and that's why we build our locks to deliver durability, convenience and unmatched value.

After all, we've built our reputation on the same standards that you have - providing quality products at a reasonable price delivered on time. It's the way we do business and it's what makes Falcon locks a powerful choice no matter what your project.



FALCON W SERIES

Whether your application is government/military, retail, industrial or multi-family, there's a W Series lock that fits perfectly. In two popular lever and two popular knob styles Falcon can match most commercial door trim.

The Falcon W Series locks feature conventional cylinders and small format interchangeable cores that are compatible with SFIC products from other manufacturers. Our conventional cylinders are available in all Falcon conventional key sections as well as Schlage C Keyway, which we now masterkey across the complete Falcon product line.

If quality product at a value price is what you are looking for, the Falcon W Series is the lock for you. And they're backed by one of the best names in the business, Ingersoll Rand.

FEATURES

**Stainless steel
latch bolt**

**UL listed latch
standard**

**Wrought brass
or bronze roses
over steel
through-bolted
rose inserts**

**Conventional cylinders
or interchangeable core
keying compatible with
SFIC products from Falcon
or other manufacturers**

**Solid, pressure-cast
zinc levers**

**Non-handed levers for
easy field installation**





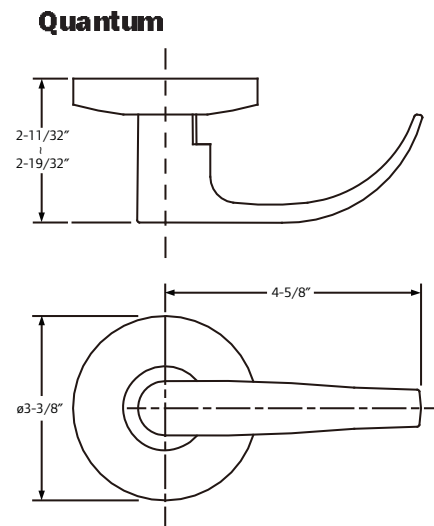
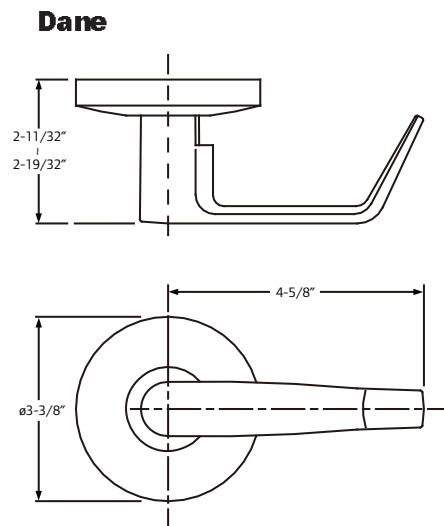

LEVERS

Levers are solid pressure-cast zinc, finished to match mating parts. Roses are wrought brass or bronze installed over steel through-bolted rose inserts. A spring-loaded retainer secures levers. Secure side retainer cannot be depressed without a key that operates the lock.

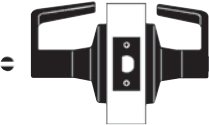

Abrasive Lever Options

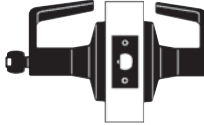
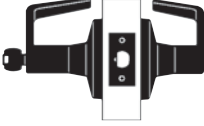
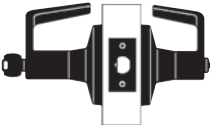
All levers are available with an abrasive strip along the length of the lever to identify entrances to areas hazardous to the disabled. To order add 6 (for example, 6DA for Dane lever or 6QU for Quantum lever) to the order number.

Catalog Number		Description	ANSI Number and Grade
W101		Passage Latchset Latch bolt by levers at all times.	F75
W161		Communicating/Exit Latch Deadlocking latch bolt by inside lever. Non-removable blank plate outside. Inside lever is always free.	
W201		Patio Lock Deadlocking latch bolt by levers. Outside lever is locked by push button from inside. Rotating inside lever or closing door releases button and unlocks outside lever.	F77
W301		Privacy Lock Latch bolt by levers. Outside lever is locked by push button on inside lever. Rotating inside lever or closing door releases push button and frees outside lever. Inside lever is always free. Emergency release in outside lever unlocks door.	F76
W501		Entry Lock Push button locking. Button on inside locks outside lever until unlocked by key or by rotating inside lever. Closing door release push button and unlocks door. Inside lever always free. Deadlock latchbolt.	F82
W511		Entry/Office Lock Deadlocking latch bolt by levers. Turn/push button locking. Pushing and turning button locks outside lever, requiring use of a key for unlocking the door until button is manually unlocked. Pushing button locks outside lever until unlocked by key or by rotating inside lever. Inside lever is always free.	F109
W561		Classroom Lock Deadlocking latch bolt by levers. Outside lever is locked by key in outside lever. Inside lever is always free.	F84
W581		Storeroom Lock Deadlocking latch bolt by lever inside or key outside. Outside lever is always locked. Inside lever is always free.	F86
W711		Apartment Entrance Lock Deadlocking latch bolt by levers. Turn/push button locking. Pushing and turning button locks outside lever, requiring use of a key for unlocking the door until button is manually unlocked. Pushing button locks outside lever until unlocked by key, by rotating inside lever, or by closing the door. Inside lever is always free.	
W12		Single Dummy Trim Single trim, surface-mounted rigid lever.	

KNOB S

Knobs are constructed of brass or cold-formed steel and are zinc-plated and dichromated for rust resistance. Springs are stainless steel. Roses are heavy-wrought brass or bronze, installed over wrought steel reinforcing plates. Knobs are brass or bronze, secured by a steel knob retainer, which cannot be depressed when lock has been locked.



Cointurn
Elite shown



Cylinder
Elite shown



Interchangeable Core
Elite shown



Plain
Hana shown



Pushbutton (interior)
Hana shown





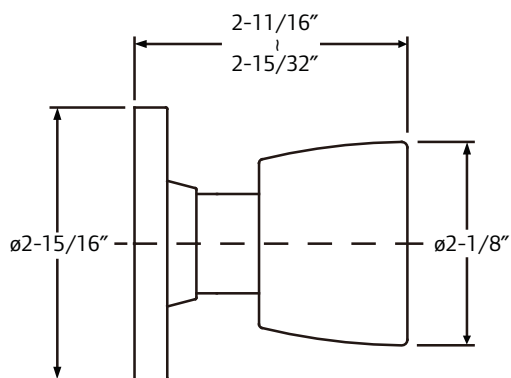

Thumbturn (interior)
Hana shown

Elite

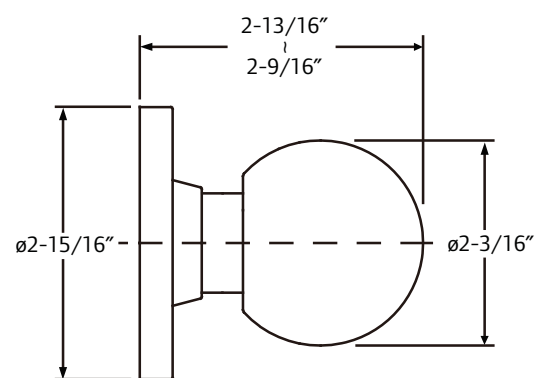

Hana

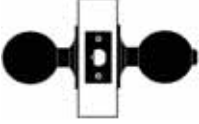
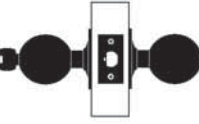
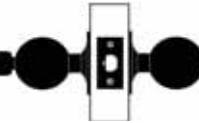
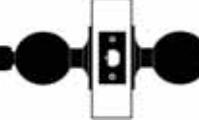
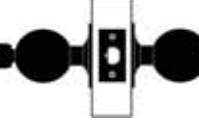
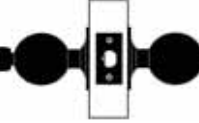

Catalog Number	Description	ANSI Number and Grade
W101	 <p>Passage Latchset Latch bolt by knob at all times.</p>	F75
W301	 <p>Privacy Lock Latch bolt by knobs. Outside knob is locked by push button on inside knob. Rotating inside knob or closing door releases push button and frees outside knob. Inside knob is always free. Emergency release in outside knob unlocks door.</p>	F76
W501	 <p>Entry Lock Push button locking. Button on inside locks outside knob until unlocked by key or by rotating inside knob.</p>	F82
W511	 <p>Entry/Office Lock Deadlocking latch bolt by knobs. Turn/push button locking. Pushing and turning button locks outside knob, requiring use of a key for unlocking the door until the button is manually unlocked. Pushing button locks outside knob until unlocked by key or by rotating inside knob. Inside knob is always free.</p>	F109
W561	 <p>Classroom Lock Deadlocking latch bolt by knobs. Outside knob is locked by key in outside knob. Inside knob is always free.</p>	F84
W581	 <p>Storeroom Lock Deadlocking latch bolt by knobs. Outside knob is always locked. Inside knob is always free.</p>	F86
W711	 <p>Apartment Entrance Lock Deadlocking latch bolt by knobs. Turn/push button locking. Pushing and turning button locks outside knob, requiring use of a key for unlocking the door until the button is manually unlocked. Pushing button locks outside knob until unlocked by key, by rotating inside knob, or by closing the door. Inside knob is always free.</p>	
W12	 <p>Single Dummy Trim Single trim, surface-mounted rigid knob.</p>	



LATCHES AND STRIKES

LATCHES

” Projection, UL Listed, Stainless Steel Bolt

- Latches for W Series locks are 3-hour UL listed.
- 2-3/4” backset standard.
- 2-3/8” backset optional.
- Unless otherwise specified we furnish a 1” x 2-1/4” square corner faceplate on 2-3/8” backset latches, and a 1-1/8” x 2-1/4” square corner faceplate on 2-3/4” backset latches.

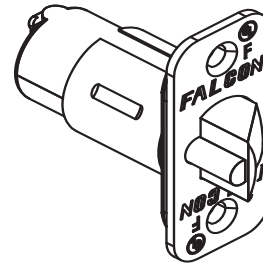

1/4” Radius Corner
1/2” Projection

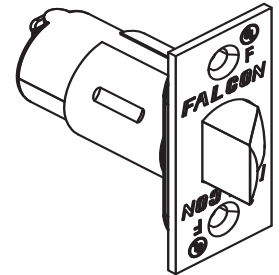

Square Corner
1/2” Projection

Catalog Number	Description (functions)	Faceplate Size	Corner
Q330-192	2-3/4” Backset Dead Locking (201, 711, 501)	1” x 2-1/4”	Square
Q330-193	2-3/4” Backset Dead Locking (201, 711, 501)	1” x 2-1/4”	Radius
Q330-194	2-3/4” Backset Dead Locking (201, 711, 501)	1-1/8” x 2-1/4”	Square
Q330-195	2-3/4” Backset Dead Locking	1” x 2-1/4”	Square
Q330-196	2-3/4” Backset Dead Locking	1” x 2-1/4”	Radius
Q330-197	2-3/4” Backset Dead Locking	1-1/8” x 2-1/4”	Square
Q330-198	2-3/8” Backset Dead Locking (201, 711, 501)	1” x 2-1/4”	Square
Q330-199	2-3/8” Backset Dead Locking (201, 711, 501)	1” x 2-1/4”	Radius
Q330-200	2-3/8” Backset Dead Locking (201, 711, 501)	1-1/8” x 2-1/4”	Square
Q330-201	2-3/8” Backset Dead Locking	1” x 2-1/4”	Square
Q330-202	2-3/8” Backset Dead Locking	1” x 2-1/4”	Radius
Q330-203	2-3/8” Backset Dead Locking	1-1/8” x 2-1/4”	Square
Q330-204	2-3/4” Backset Spring Latch	1” x 2-1/4”	Square
Q330-205	2-3/4” Backset Spring Latch	1” x 2-1/4”	Radius
Q330-206	2-3/4” Backset Spring Latch	1-1/8” x 2-1/4”	Square
Q330-207	2-3/8” Backset Spring Latch	1” x 2-1/4”	Square
Q330-208	2-3/8” Backset Spring Latch	1” x 2-1/4”	Radius
Q330-209	2-3/8” Backset Spring Latch	1-1/8” x 2-1/4”	Square

STRIKES

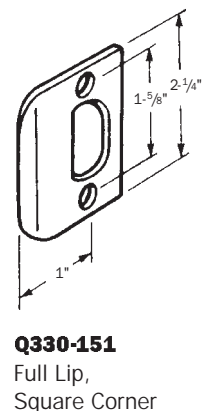
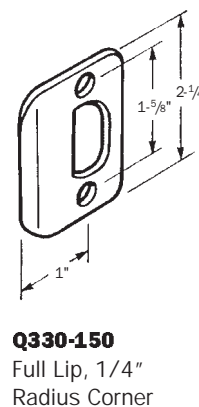
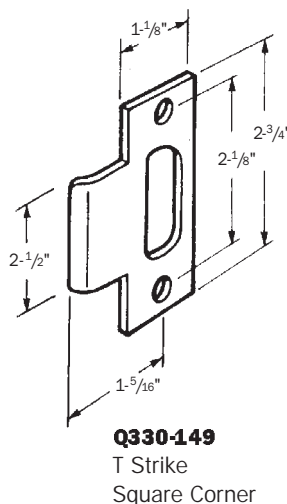
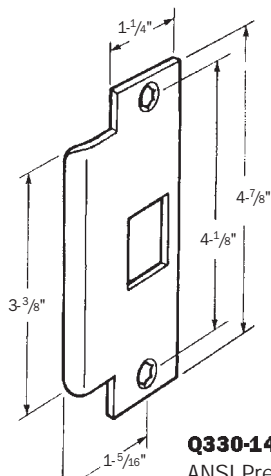

CYLINDERS AND ACCESSORIES

FALCON STANDARD CYLINDERS

6-Pin

Catalog Number	Description
Q330-154	Falcon (specify keyway)
Q330-155	Falcon (for W561)

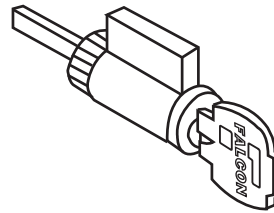

Specify finish: 606 or 626

Specify keyway: G (standard), H, K, L, N, P

Standard Cylinder

STANDARD CYLINDERS WITH OTHER KEYWAYS

6-Pin

Catalog Number	Description
Q330-152	Schlage C
Q330-153	Schlage C for W561
Q330-166	Corbin 60 (0 bit or KD only)
Q330-167	Corbin 60 (0 or KD only) for W561
Q330-210	Russwin D1 (0 bit or KD only)
Q330-211	Russwin D1 (0 bit or KD only) for W561
Q330-158	Cor/Russ L4 (0 bit or KD only)
Q330-159	Cor/Russ L4 (0 bit or KD only) for W561
Q330-160	Sargent LA (0 bit or KD only)
Q330-161	Sargent LA (0 bit or KD only) for W561
Q330-164	Tailpiece for Q330-154 Falcon and Schlage cylinders (All other functions)
Q330-165	Tailpiece for Q330-155 Falcon and Schlage cylinders (W 561 function only)
Q330-168	Tailpiece for SFIC (All functions)
Q330-156	Yale 8 (0 bit or KD only)
Q330-169	Tailpiece for W Lock knobs — SFIC

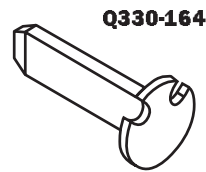

Conventional cylinder tailpiece

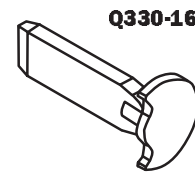

Conventional cylinder tailpiece W561

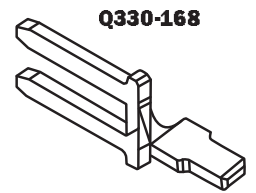

IC Core tailpiece

FALCON INTERCHANGEABLE CORE

Catalog Number	Description
C606 (6-pin), C607 (7-pin)	For use in all I/C keyed locks (cover style)
CB806 (6-pin), CB807 (7-pin)	For use in all I/C keyed locks (cap style)

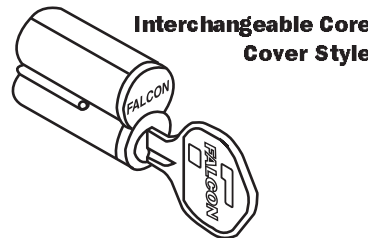

Interchangeable Core Cover Style

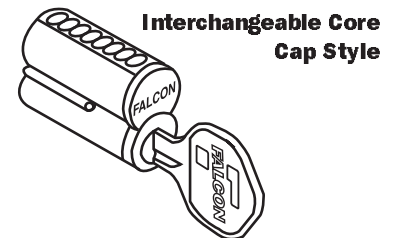

Interchangeable Core Cap Style

Specify finish: 606 or 626

Specify keyway: A (standard) or other keyway

CONVERSION CHART

W Series Grade 2 Cylindrical Key-in-Lever

ANSI	Function	FALCON	Arrow	Cal-Royal	Corbin/Russwin	Dorma	Hager	Marks	Best
C75	Passage	W101	RL01	SL-30	CL3810	CL710	3510	N	7KN
	Comm/Exit	W161	RL03	SL-50	-	CL725	3525	DC	-
F77	Patio	W201	RL04	-	CL3840	CL730	-	P	-
F76	Privacy	W301	RL02	SL-20	CL3820	CL740	3540	L	7KL
F109	Entry/Office	W511	RL11	-	CL3851	CL753	3553	AB	7KAB
F84	Classroom	W561	RL17	SL-03	CL3855	CL770	3570	S	7KR
F86	Storeroom	W581	RL12	SL-05	CL3851	CL780	3580	F	7KD
	Apt. Entry	W711	-	-	-	-	-	-	-
	Dummy Single	W12	RL08	SL-40	CL3850	CL701	3517	DO	7KIOT
F82	Entry	W501	-	SL-00	CL3861	CL750	-	B	-
Trim Syles		FALCON	Arrow	Cal-Royal	Corbin/Russwin	Dorma	Hager	Marks	S. Parker
		DANe	SR	SL	N2D	LR	Withnell	170	SL
		QUAntum	BRR	RL	PZD	LC	Archer	270	-

CONSTRUCTION KEYING

Falcon offers two different construction key systems depending on the size of and application within the project. Both systems permit the installation and use of regular door locks during construction, yet completely preserve the security of the keying system for the building owner. The Master, Grand Master and change keys are never with the locks during the construction phase of a building. Only the "construction" keys are sent to the jobsite. Where the job permits we will use the "Lost Pin" system as our standard system for construction keying. Larger or more complicated jobs may require use of the "Blockokey® System" for construction keying.

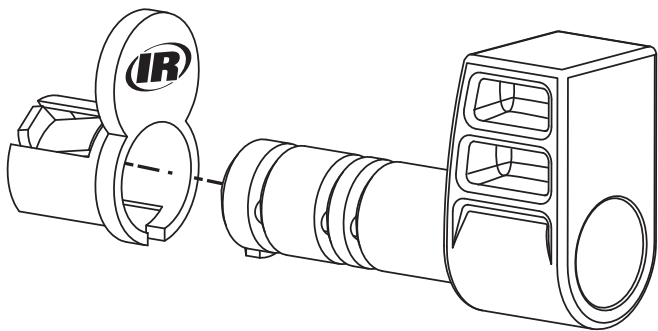

"DISPOSABLE CONSTRUCTION" INTERCHANGEABLE CORES

The disposable construction core (1408) is an inexpensive alternative to interior keyed construction cores. This core should be used on interior door applications or where security on a site is not a concern. No keys need to be issued. The disposable core is inserted in the lever or knob, and is operated by a thumbturn, which retracts the latch bolt. Use either brass or permanent construction cores on exterior doors or secured areas when security is needed.

LOCKS WITH THE "LOST PIN" SYSTEM

Our "lost pin" construction system consists of one construction pin and a shallow hole in the side of the plug.

All lock cylinders on a specific project are operable by a special "project key." The building contractor may assign all duplicates of this key to workers and subcontractors as required. No regular change keys or master keys are needed on the job, eliminating the possibility of subsequent exposure from lost or stolen keys.

Construction Key - KB566

With the construction key in use the construction pin is always in the cylinder plug, sitting on top of the bottom pin.

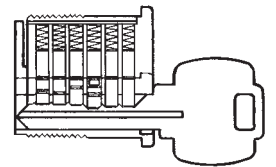

Master Key - KB578

With the master key inserted the construction pin is pushed up into the cylinder housing. Rotating the master key to the right drops the construction pin into the hole in the plug, eliminating any future use of the construction key.

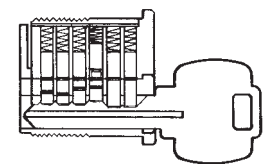

Construction Pin

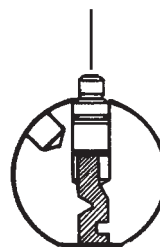

Construction Pin

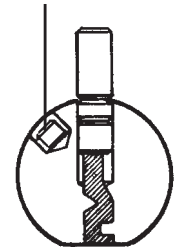
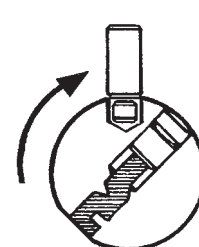

HOW BLOCKOKEY CYLINDERS ARE USED

1. Project Key - KB531

Operation of the lock cylinder is by the special "project key." The last two pins in the cylinder are inoperative because of the "key block" mechanism.

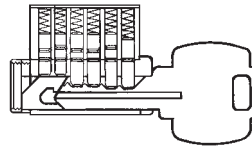

2. Removal Tool - KB536

The "project key" no longer operates the cylinder when the "key block" mechanism is removed. A key block removal tool comes with the master keys for the locks. Push the removal tool into the keyway and then withdraw it to remove the block. Thereafter the project key will no longer operate the lock cylinder.

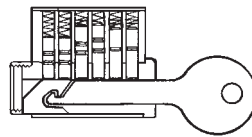

3. Change or Master Keys - KB578

Cylinder is now only operable by the regular change key or master key.

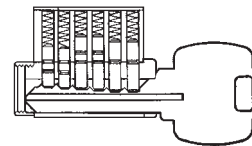

HOW TO ORDER LOCKS WITH BLOCKOKEY SYSTEM

Blockokey locksets are ordered by adding the word "Blockokey" after the balance of the ordering information and are only available in Falcon keyways.

For example: 72 W511PD DAN 626 RH 30-209 30-149 1AA-72AA (Blockokey)



FEATURES AND SPECIFICATIONS

Door Thickness: 1- $\frac{3}{8}$ " to 1- $\frac{3}{4}$ " standard.

Backset: 2- $\frac{3}{4}$ " standard; 2- $\frac{3}{8}$ " also available.

Mechanism: Parts constructed of brass or cold-formed steel, zinc plated and dichromated for rust resistance. Springs are stainless steel.

Attachment: Lock chassis secured to door by two screws which pass through a steel rose insert inside and thread directly into the outer rose-mounting assembly, and two screws that screw into the chassis assembly.

Handing: Locks are non-handed.

Cylinder: Pinning in six chambers. Cylinder assemblies removable to re-key. Also available with 6- or 7-pin interchangeable core cylinders. Cylinder housings and plugs machined from solid brass. Springs are stainless steel. Two nickel silver keys furnished standard.

Competitor Cylinder: The W Series accepts standard 6-pin cylinders available from Falcon, as well as Schlage, Corbin-Russwin, Yale and Sargent.

Keyways: "G" keyway standard on Falcon standard cylinders. "A" keyway standard on I/C core cylinders. Also available with some optional keyways. Schlage "C" keyway also available on standard cylinders, includes master key. Master keying available on all Falcon and Schlage "C" keyways.

Trim: Roses are heavy wrought brass or bronze, installed over steel rose inserts which are through-bolted through door. Levers are pressure-cast zinc (solid levers-no-inserts) finished to match mating parts.

Latches: $\frac{1}{2}$ " bolt projection made of stainless steel and UL listed for 3-hour door assemblies. Latches have self-adjusting fronts to accommodate beveled or flat doors. 2- $\frac{3}{8}$ " backset with 1" x 2- $\frac{1}{4}$ " latch faces or 2- $\frac{3}{4}$ " backset with 1- $\frac{1}{8}$ " x 2- $\frac{1}{4}$ " latch faces.

Strikes: 4- $\frac{7}{8}$ " x 1- $\frac{1}{4}$ " ANSI strike with curved lip to meet ANSI A115.2 door frame preparation standard. Consult Options and Accessories section for other available strikes, sizes and configurations.

Screws: Furnished with combination screws for use in wood or metal doors and frames.

ANSI/BHMA: Meets ANSI/BHMA A156.2, Series 4000, Grade 2.

UL: 3-hour A label.

SPECIFICATIONS

Key-in-lever cylindrical locksets shall be Falcon W Series or equal, and meet the following requirements:

- All locks shall meet ANSI/BHMA A156.2, Series 4000, Grade 2 test requirements for key-in-lever locksets.
- Locksets shall be UL listed 3 hour A Label.
- Lever trim shall have individual heavy-duty springs for lever return and to prevent lever sag. Trim shall be through-bolted.
- All lever designs shall be solid (no inserts) and meet the federal ADA and state disability requirements.
- Locksets shall adjust to fit door thickness from 1-³/₈" to 1-³/₄".
- All locksets shall be non-handed and shall not require field disassembly for re-handing.
- Preparation for door must be non-handed.
- Acceptable manufacturer: Falcon Lock

DOOR TEMPLATING

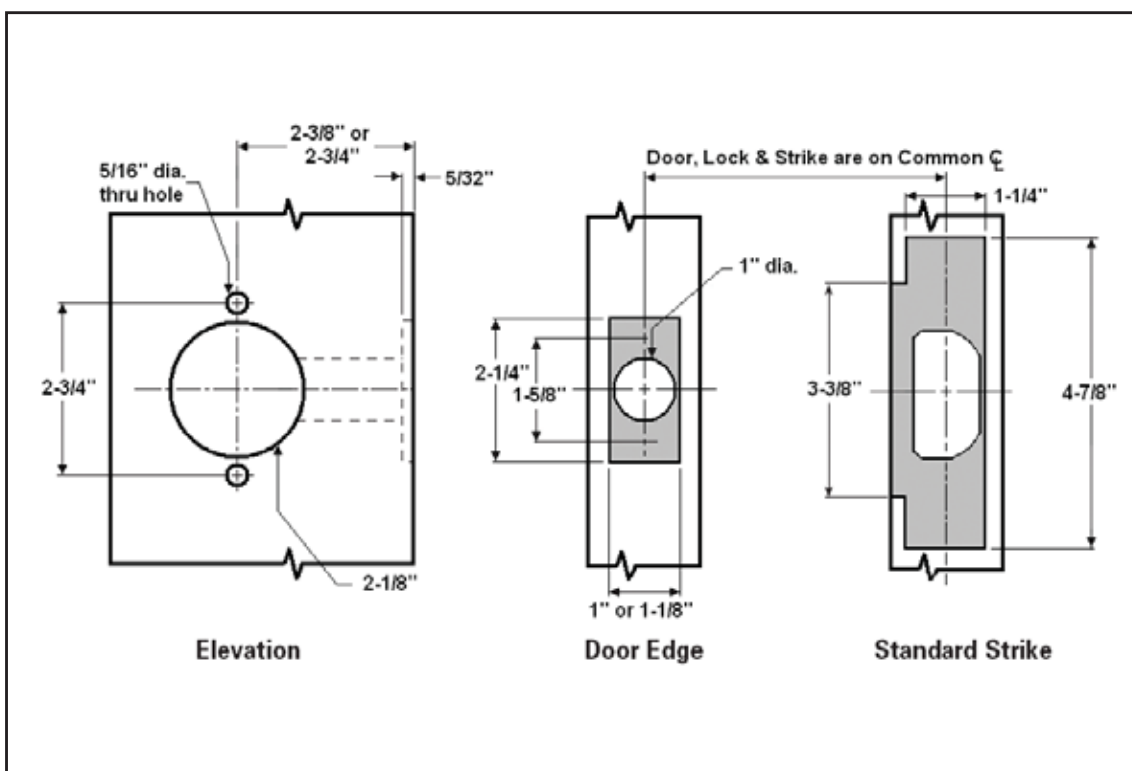

HOW TO ORDER

For correct ordering and to ensure no delays in shipment of your order, the following descriptive data must be listed in the sequence shown. Necessary information can be found in other parts of this catalog. The example to the right shows an order for 12 each W locksets in the 581 storeroom function, QUA (Quantum) trim design in a 626 (satin chrome) finish, with a 2-3/4" backset latch, to accommodate doors 1-3/4" thick.

Quantity: Indicate the quantity required.

Catalog number: Select function number, cylinder type and latch style from tables in this section.

Trim design: Indicate letter of lever design. DAN = Dane; QUA = Quantum; ELI = Elite; HAN = Hana. Outside design always precedes inside design on split designs. If adding an abrasive lever option, add 6 to design code (example 6DAN).

Finish: When the finish is the same for the outside and inside trim it is shown once (ex.: 626). Outside finish always precedes inside finish on split finishes (ex.: 605 x 625).

Latches: 2-3/4" backset standard. 2-3/8" backset available. All latches are UL listed 3-hour A label.

Strikes: 4-7/8" x 1-1/4" ANSI strike standard. Optional T strike or Full Lip strikes available. See page 8.

Cylinder type: 6-pin.

Keying Detail: We suggest using standard terms developed by DHI (Door & Hardware Institute) or ALOA (Associated Locksmiths of America). Example: AA1-Grand Master keyed, Master keyed, change key 1.

Interchangeable core: To order product capable of accepting an interchangeable core, add suffices from the keying table to the function number, preceding the latch style. Example: W511HD will be supplied with SFIC keyed construction core.

Keyways: "G" is standard on regular cylinders. "A" is standard on interchangeable cores. Other keyways available. See page 9.

Additional keys: Note the total number of keys required.
Large bow keys: Add "with large bow keys" under additional details.

SAMPLE ORDER

Line Item	QTY	Product	Outside		Inside		Hand	Latch	Strike	Door Thickness	EXT	DIM	Additional Details/Keying
			DES	FIN	DES	FIN							
1	12	W581D	QUA	626			RHR	30-197	30-149	13/4			

EXAMPLE: Twelve W Series storeroom function locks with a Quantum lever in 626, 2-3/4" backset latch, T-strike, to accommodate doors 1-3/4" thick.

FINISHES

* All finishes available in all trim.



Bright Brass
605



Satin Brass
606



Oil Rubbed
Bronze
613



Bright Chrome
625



Satin Chrome
626

Although we apply the finest available protective plating and/or clear coating to the surface of our products, these finishes have limitations and, in time, may deteriorate from exposure to weather, pollution, perspiration, extremes of climate, frequency of use or other factors. Deterioration of finishes is, therefore, not a defect, but a normal process that is unavoidable. Falcon Lock cannot accept responsibility for finish deterioration under these circumstances; therefore, finishes cannot be guaranteed. These products will not be refinished or replaced under our warranty should deterioration of finish occur.



Ingersoll Rand's Security Technologies Sector is a leading global provider of products and services that make environments safe, secure and productive. The sector's market-leading products include electronic and biometric access-control systems; time-and-attendance and personnel scheduling systems; mechanical locks; portable security; door closers, exit devices, architectural hardware, and steel doors and frames; and other technologies and services for global security markets.

800-266-4456

www.falcon.ingersollrand.com

www.ingersollrand.com