

19398 INSTRUCTIONS

Thank You

You've just purchased a lighting product designed and built to provide you with years of enjoyment.

Merci

Vous venez d'acheter une luminaire conçu pour vous donner des années de plaisir.

Gracias

Usted acaba de adquirir un excelente producto de alumbrado diseñado y construido para proveerle muchos años de satisfacción.

SAVE THESE INSTRUCTIONS FOR FUTURE REFERENCE

- Follow the assembly Instructions by reading the numerical progression
- Use a qualified electrician for installation of this lighting fixture.
- Before installing fixture disconnect power by turning the circuit breaker or by removing the fuse at the fuse box.
- Use CSA or UL listed wire connectors suitable for the gauge, type and number of conductors.
- If fixture has 2 grounding wires (one from the frame and one from the canopy) connect both wires together, and then connect them either to ground screw or ground wire of junction box, or the ground screw on the crossbar.



GARDEZ CES INSTRUCTIONS POUR CONSULTATION FUTURE

- Executer les operations de montage, en suivant l'ordre de numeration progressif
- Employez un électricien qualifié pour l'installation de ce luminaire.
- Coupez le courant au boîtier principal.
- Utiliser les marettes CSA ou UL qui conviennent au jauge, au type et au nombre de conducteurs
- Si la fixture a 2 fils de terre (un du cadre et un du canope) relier les deux file ensemble, ensuite relier les file soit a la vis de terre, soit au fil de terre de la boite de derivation, soit a la vis de terre sur la barre transversale.

GUARDE ESTAS INSTRUCCIONES PARA CONSULTÁRLAS EN ÉL FUTURO

- Ejecutar las operaciones de montaje siguiendo el orden numerico progresivo
- Use un electricista certificado para la propio ensamblamento é instalacion
- Antes de instalar el accesorio, desconecte la energia apagando el interruptor o qui tando el fusible en la caja principal
- Utilice conectores de cable clasitació CSA o UL adecuados para el calibre, tipo y número de conductores.
- Si el aditamento tiene dos cables de tierra (uno del marco y uno del canope), conecte ambos cables juntos y después conéctelos al tornillo de tierra o al cable de tierra de la caja de conexiones o al tornillo de tierra de la barra transversal.

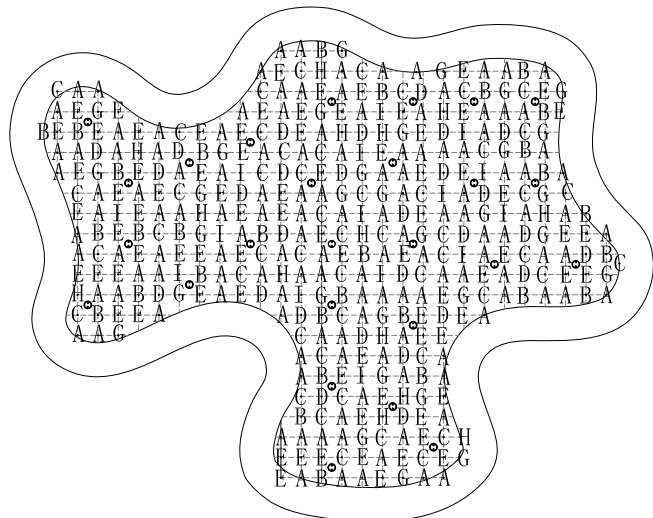
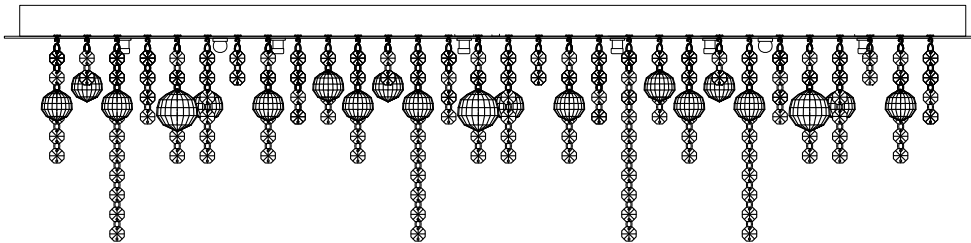

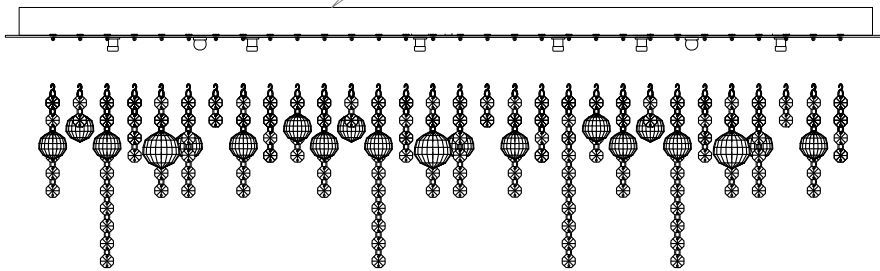
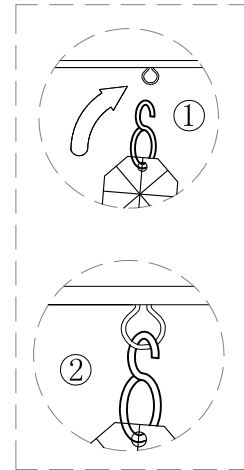
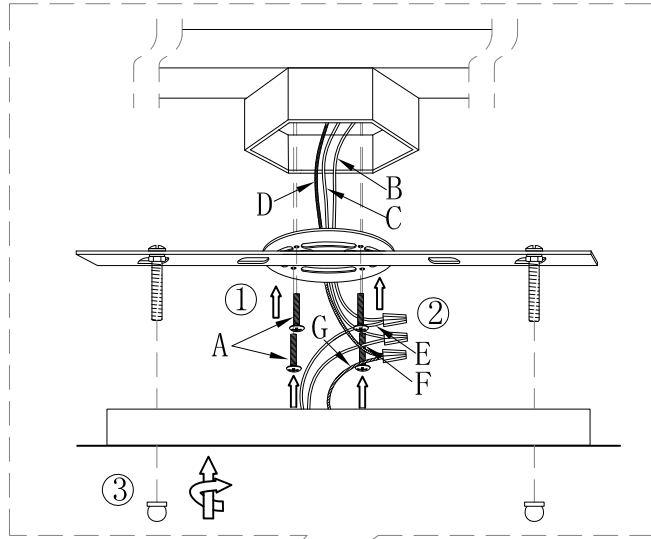

26 x 20W MAX,G4 12V,60Hz
(Bulb is included)

26 x 20W MAX,G4 12V,60Hz
(L'ampoules inclus)

26 x 20W MAX,G4 12V,60Hz
(Bombillas incluido)

A-Mounting screws x 2 (provided)
B-Black wire (L) from junction box
C-White wire (N) from junction box
D-Green wire/bare copper (G)
from junction box
E-Black wire from fixture
F-White wire from fixture
G-Bare wire from fixture

A-Vis de support x 2 (fournies)
B-Câble noir (L) de la boîte de
raccordement
C-Câble blanc (N) de la boîte de
raccordement
D-Câble vert/Cuivre nu (G) de la
boîte de raccordement
E-Câble noir de l'installation
F-Câble blanc de l'installation
G-Câble un de l'installation

A-(2)tornillos de montaje (incluidos)
B-Cable negro (L) de la caja de
conexiones
C-Cable blanco (N) de la caja de
conexiones
D-Cable verde/cobre pelado (G) de
la caja de conexiones
E-Cable negro del aditamento
F-Cable blanco del aditamento
G-Cable pelado del aditamento

19398

INSTRUCTIONS

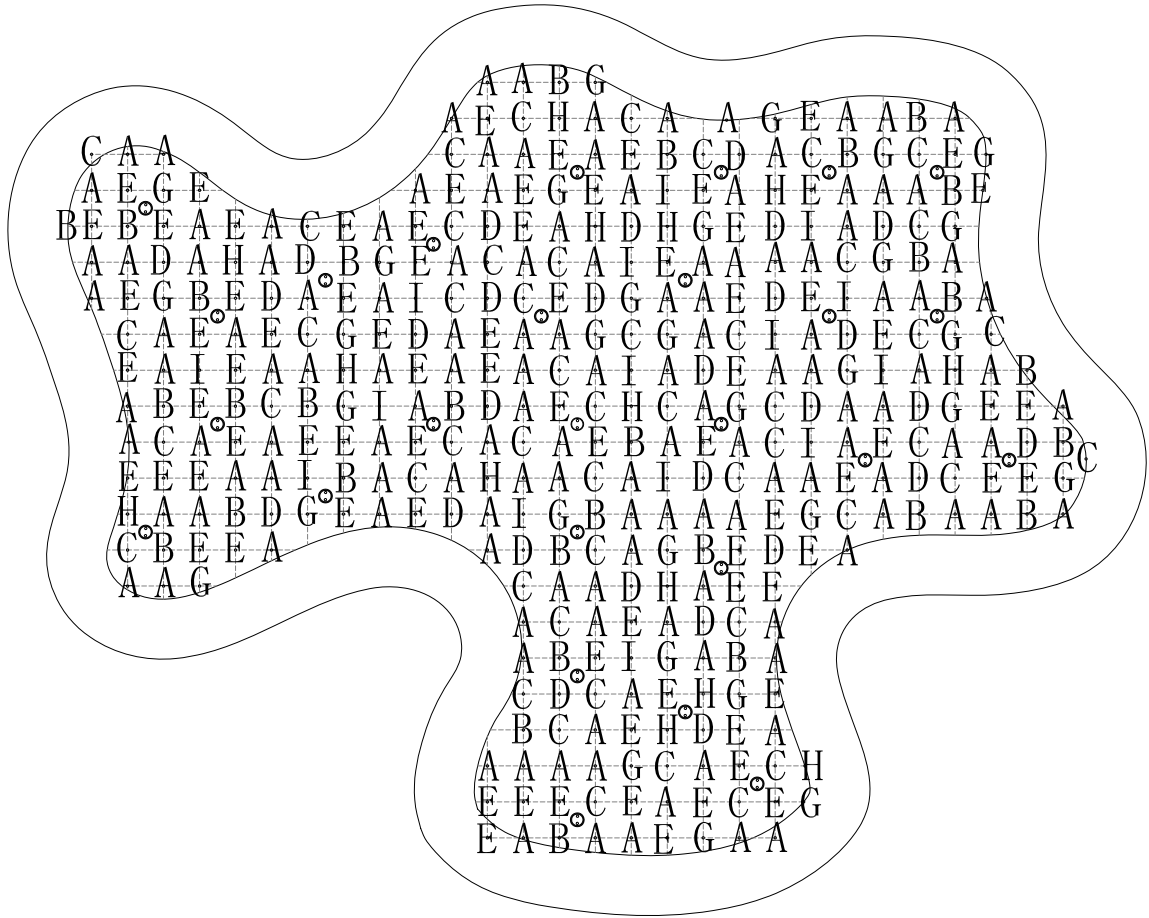

A: 137pcs 

B: 30pcs 

C: 49pcs 

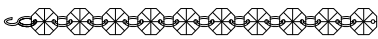
D: 28pcs 

E: 79pcs 

G: 31pcs 

H: 14pcs 

I: 15pcs 