



Contemporary
Lighting™

PRODUCT NAME: Blocs

ITEM NUMBER: E32033-18PC

Please consult your electrician for hanging fixture and wiring.

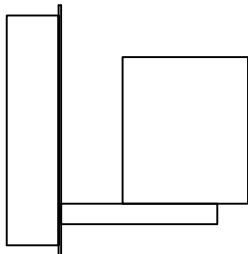
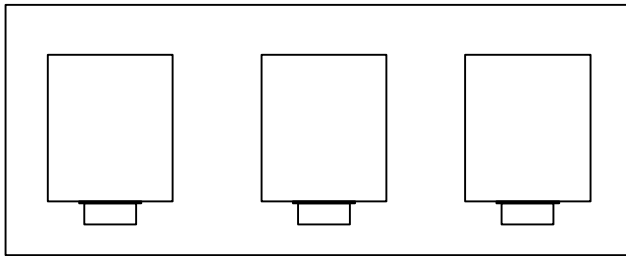

This fixture is designed to dim with an Electronic Low Voltage dimmer. Dimming levels will vary by dimmer. Below is a List of Recommended Dimmers:

- Lutron MACL-153M
- Leviton IPL06-10Z

Due to inrush current, wattage should not exceed 150 Watts of product for a 600 Watt dimmer.

Warning! This fixture is supplied with an installed LED driver. These fixtures are dimmable using standard triac dimmer. For best operation we recommend using Lutron CL Dimmers.

Bulbs (Included): 3*2.2W G9LED

IMPORTANT: Turn off the power at the main fuse or circuit breaker box before starting installation



(A)
Mounting Bracket



(B)
Anchor Bolts



(C)
Screws

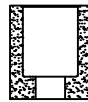

(D)
Acrylic



(E)
Socket ring

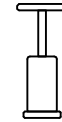

(F)
Socket Wrench



(G)
bulbs

Locate all hardware & components before discarding packaging

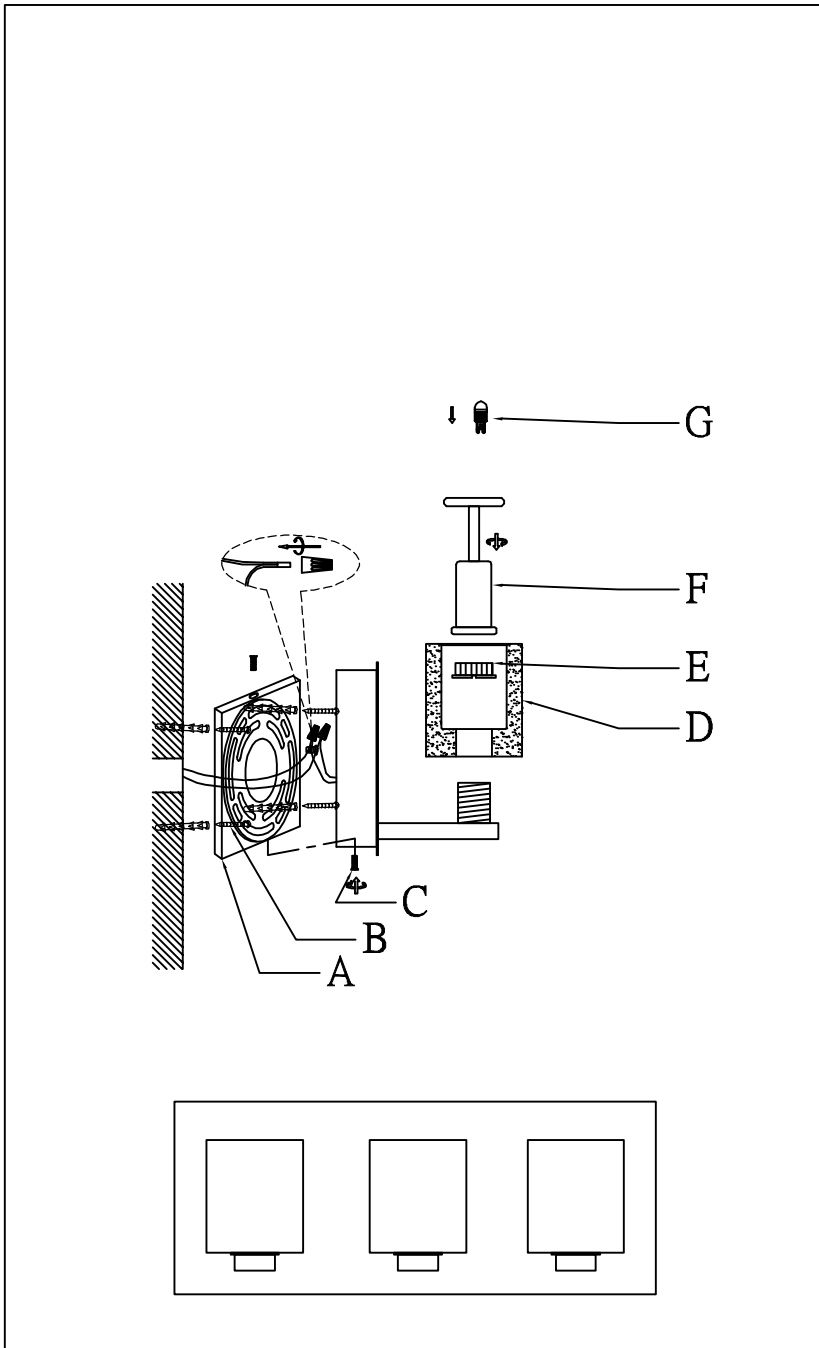

Cleaning & Care:

Clean with soft cloth and a mild detergent.
Do not use abrasive cleaner.

1.)

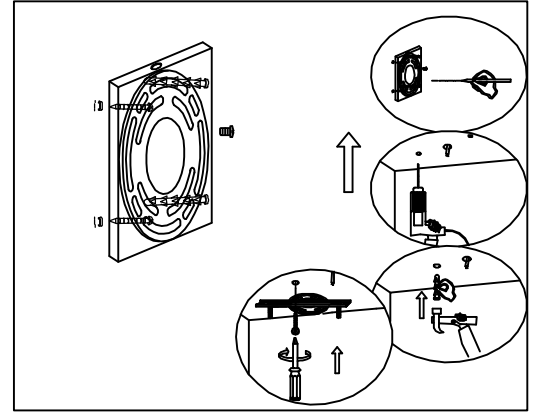

Step.1: Remove mounting bracket (A) and install 1 electrical box. Mark where anchors meet the wall, remove mounting bracket from the wall, and drill holes using $\frac{3}{16}$ " drill bit where marked (B). Install mounting bracket and attach anchors to secure bracket at ends.

2.)

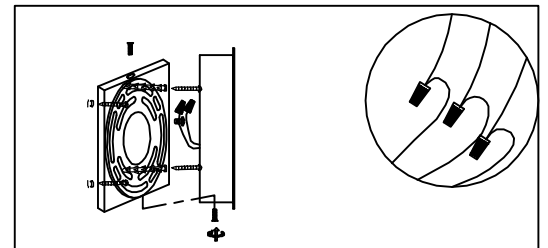

Step.2: Wire fixture to wires in outlet box. Green wire is for Ground, install fixture to the bracket and tighten finial (C) until the fixture is flush with the wall.

3.)

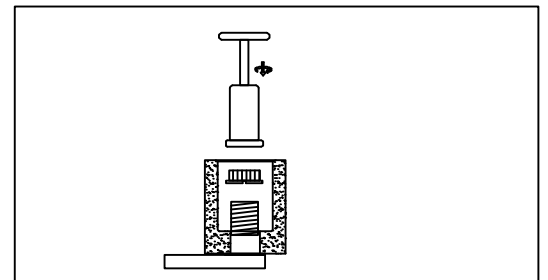

Step.3: Secure the acrylic (D) with the screw ring (E) over the socket and tighten using socket wrench (F)

4.)

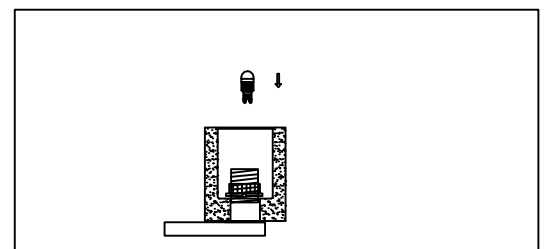

Step.4: Install maximum 2.2W G9LED Xenon bulbs (G) to the socket.

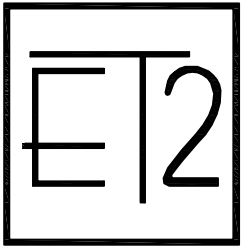

Contemporary Lighting™

Model E32033-18PC
Crystal Diagram

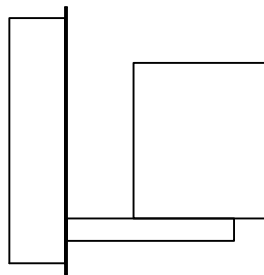
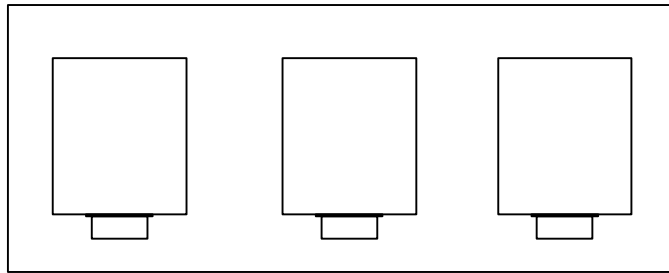

A: 3pcs
EGLS22030-18