

3 1/2" x 3 1/2" Heavy Duty Plain Bearing with 5/8" Radius Corners

Residential Hinges

Plain Bearing, 304 Grade, 0.093" - 0.096" Thick

Description	Product Code
3 1/2" x 3 1/2" with Square Corners	9811332D
3 1/2" x 3 1/2" with 1/4" Radius Corners	9812332D
3 1/2" x 3 1/2" with 5/8" Radius Corners	9813332D

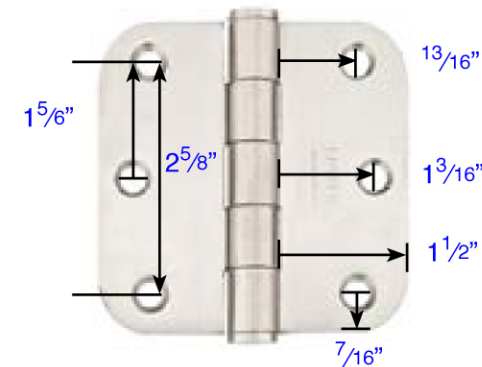

3 1/2" x 3 1/2" Heavy Duty Plain Bearing with 1/4" Radius Corners

Heavy Duty Hinges

Plain Bearing, 304 Grade, 0.113" - 0.135" Thick

Description	Product Code
3 1/2" x 3 1/2" with Square Corners	9821332D
3 1/2" x 3 1/2" with 1/4" Radius Corners	9822332D
3 1/2" x 3 1/2" with 5/8" Radius Corners	9823332D

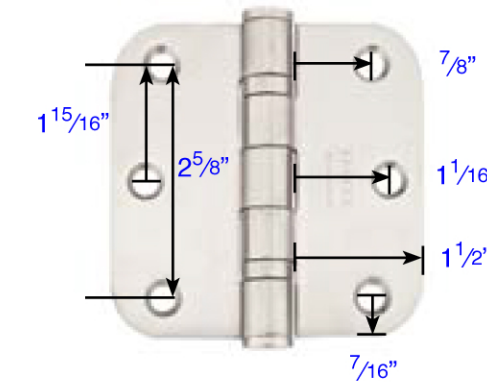

3 1/2" x 3 1/2" Heavy Duty Ball Bearing with 1/4" Radius Corners

Heavy Duty Hinges

Ball Bearing, 304 Grade, 0.113" - 0.132" Thick

Description	Product Code
3 1/2" x 3 1/2" with Square Corners	9841332D
3 1/2" x 3 1/2" with 1/4" Radius Corners	9842332D
3 1/2" x 3 1/2" with 5/8" Radius Corners	9843332D

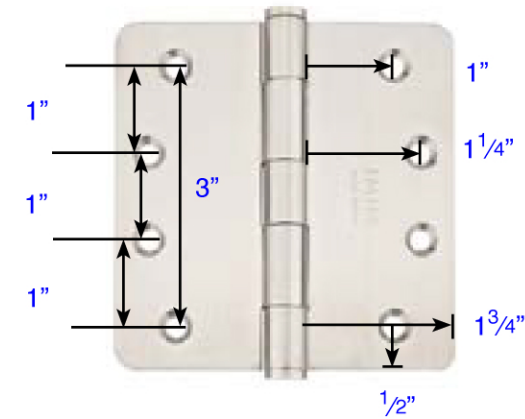

4" x 4" Heavy Duty Plain Bearing with 1/4" Radius Corners

Residential Hinges

Plain Bearing, 304 Grade, 0.093" - 0.096" Thick

Description	Product Code
4" x 4" with Square Corners	9811432D
4" x 4" with 1/4" Radius Corners	9812432D
4" x 4" with 5/8" Radius Corners	9813432D

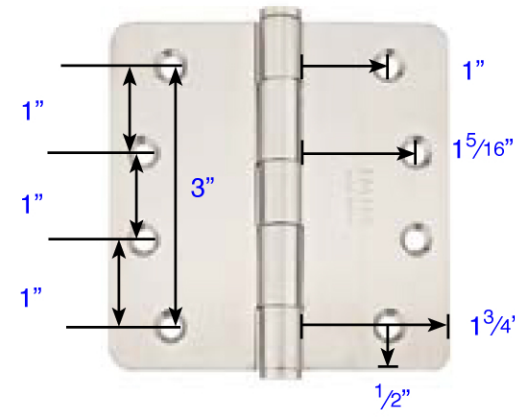

4" x 4" Heavy Duty Plain Bearing with 1/4" Radius Corners

Heavy Duty Hinges

Plain Bearing, 304 Grade, 0.113" - 0.135" Thick

Description	Product Code
4" x 4" with Square Corners	9821432D
4" x 4" with 1/4" Radius Corners	9822432D
4" x 4" with 5/8" Radius Corners	9823432D

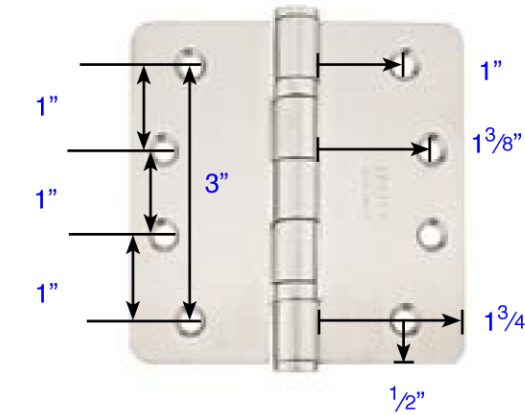

4" x 4" Heavy Duty Ball Bearing with 1/4" Radius Corners

Heavy Duty Hinges

Ball Bearing, 304 Grade, 0.113" - 0.132" Thick

Description	Product Code
4" x 4" with Square Corners	9841432D
4" x 4" with 1/4" Radius Corners	9842432D
4" x 4" with 5/8" Radius Corners	9843432D

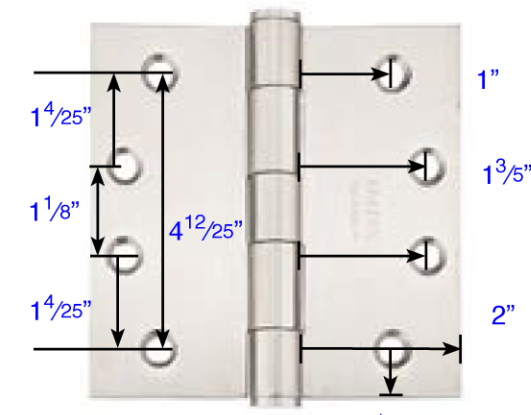

4 1/2" x 4 1/2" Residential Duty Plain Bearing with Square Corners

Heavy Duty Hinges

Plain Bearing, 304 Grade, 0.113" - 0.135" Thick

Description	Product Code
4 1/2" x 4 1/2" with Square Corners	9821532D

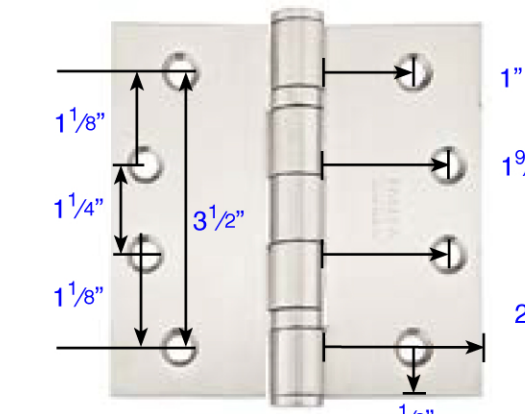

4 1/2" x 4 1/2" Residential Duty Ball Bearing with Square Corners

Heavy Duty Hinges

Ball Bearing, 304 Grade, 0.113" - 0.132" Thick

Description	Product Code
4 1/2" x 4 1/2" with Square Corners	9841532D