

PRODUCT SPECIFICATIONS

Gourmet (Lustertone®) Stainless Steel Single Bowl Top Mount Quick-Clip® Sink. Overall dimensions are 25" x 21-1/4" x 5". Sink is manufactured from 18 gauge 304 Stainless Steel with a Lustrous Highlighted Satin finish, Rear Center drain placement and Full spray sides and bottom.

Installation Type:	Top Mount
Material:	304 Stainless Steel
Special Features:	Quick-Clip Mounting System
Finish:	Lustrous Highlighted Satin
Gauge:	18
Sound Deadening:	Full spray sides and bottom
Number of Bowls:	1
Sink Dimensions:	25" x 21-1/4" x 5"
Bowl 1 Dimensions:	21" x 15-3/4" x 4-7/8"
Drain Size:	3-1/2" (89mm)
Drain Location:	Rear Center
Minimum Cabinet Size:	30"
Mounting Hardware:	Included for 3/4" (19mm) countertop
Cutout Template #:	1000001245

Template is available for download at [elkay.com](#)

Cutout Dimensions for Top Mount Installation:

24-3/8" x 20-5/8" (619mm x 524mm) with 1-1/2" (38mm) corner radius



This sink is compliant to ADA and ANSI/ICC A117.1 accessibility requirements when installed according to the requirements outlined in these standards.

Hole Drilling Configurations:

1-1/2" (38mm) Diameter Faucet Holes on 4" (102mm) Centers

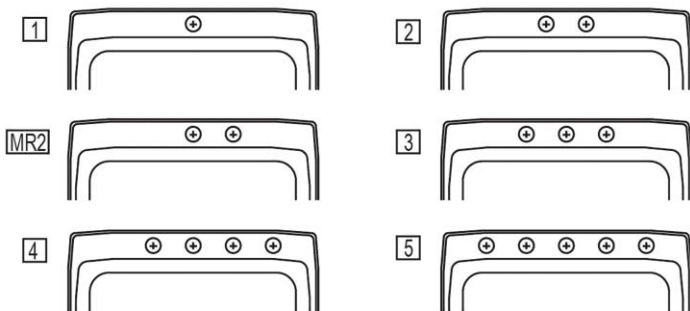

AMERICAN PRIDE. A LIFETIME TRADITION. Like your family, the Elkay family has values and traditions that endure. For almost a century, Elkay has been a family-owned and operated company, providing thousands of jobs that support our families and communities.



Sinks are listed by IAPMO® as meeting the applicable requirements of the Uniform Plumbing Code®, International Plumbing Code®, and National Plumbing Code of Canada.

Product Compliance: ADA
BUY AMERICAN ACT
ASME A112.19.3/CSA B45.4

[Clean and Care Manual \(PDF\)](#)
[Installation Instructions \(PDF\)](#)
[Limited Lifetime Warranty \(PDF\)](#)

Similar models are available with: additional ADA depths, U Channel mounting system

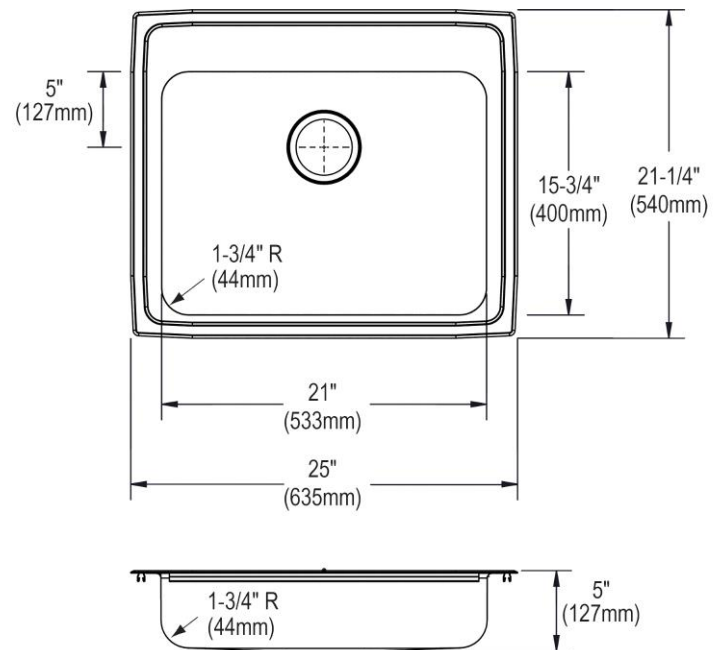

PART: _____ QTY: _____
 PROJECT: _____
 CONTACT: _____
 DATE: _____
 NOTES: _____
 APPROVAL: _____

In keeping with our policy of continuing product improvement, Elkay reserves the right to change product specifications without notice. Please visit [elkay.com](#) for the most current version of Elkay product specification sheets. This specification describes an Elkay product with design, quality, and functional benefits to the user. When making a comparison of other producers' offerings, be certain these features are not overlooked.

Installation Profile:

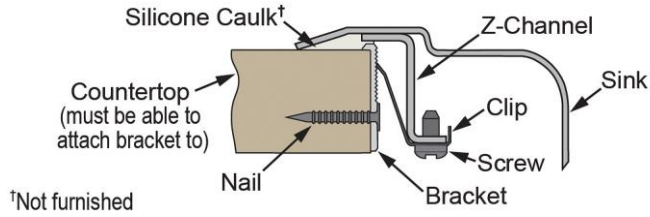

OPTIONAL ACCESSORIES

Bottom Grid:	LKWOBG2115SS
Cutting Board:	CB1516
Drain:	LK99, LKAD35
Faucet:	LKGT1041, LKGT2041
Rinsing Basket:	LKWRB2115SS, LKWERBSS
Sinkmate:	LKSM17, LKSMHOOK, LKSMSPONGE, LKSMHSL
Soap Dispenser:	LKGT1054

In keeping with our policy of continuing product improvement, Elkay reserves the right to change product specifications without notice. Please visit elkay.com for the most current version of Elkay product specification sheets. This specification describes an Elkay product with design, quality, and functional benefits to the user. When making a comparison of other producers' offerings, be certain these features are not overlooked.