

**PRODUCT SPECIFICATIONS**

Quartz Luxe<sup>®</sup> 33" x 18-7/16" x 9-7/16" Single Bowl Undermount Sink. Proprietary manufacturing process that combines natural quartz with high performance UV-stable acrylic resins results in an impact resistant, nonporous and heat-, scratch-, stain- and fade-resistant surface. Naturally sound deadening and Rear Center drain placement.



<b>Installation Type:</b>	Undermount
<b>Material:</b>	Quartz
<b>Finish:</b>	Arctic Fox (FX), Caviar (CA), Charcoal (CH), Chestnut (CN), Obsidian (DN), Parchment (PA), Ricotta (RT), Sandstone (SD), Silvermist (SM)
<b>Number of Bowls:</b>	1
<b>Sink Dimensions:</b>	33" x 18-7/16" x 9-7/16"
<b>Bowl 1 Dimensions:</b>	30-1/4" x 16-5/16" x 9-7/16"
<b>Drain Size:</b>	3-1/2" (89mm)
<b>Drain Location:</b>	Rear Center
<b>Minimum Cabinet Size:</b>	36"
<b>Mounting Hardware:</b>	Part # 54300408 included
<b>Template Included:</b>	Yes
<b>Cutout Template #:</b>	<a href="#">1000003468</a>

A Century of Tradition and Quality. For more than 100 years, Elkay has been making innovative products and providing exceptional customer care. We take pride in offering plumbing products that make life easier, inspire change and leave the world a better place.



**Product Compliance:** CSA B45.5/IAPMO Z124

Template is available for download at [elkay.com](#). CAD software will be required to open the template.

**Special Note:** Reserve Selection products are sold exclusively, in-store and online, through authorized wholesalers.



Sinks are listed by IAPMO<sup>®</sup> as meeting the applicable requirements of the Uniform Plumbing Code<sup>®</sup>, International Plumbing Code<sup>®</sup>, and National Plumbing Code of Canada.

[Clean and Care Manual \(PDF\)](#)  
[Installation Instructions \(PDF\) - 1000005238](#)  
[Warranty \(PDF\)](#)

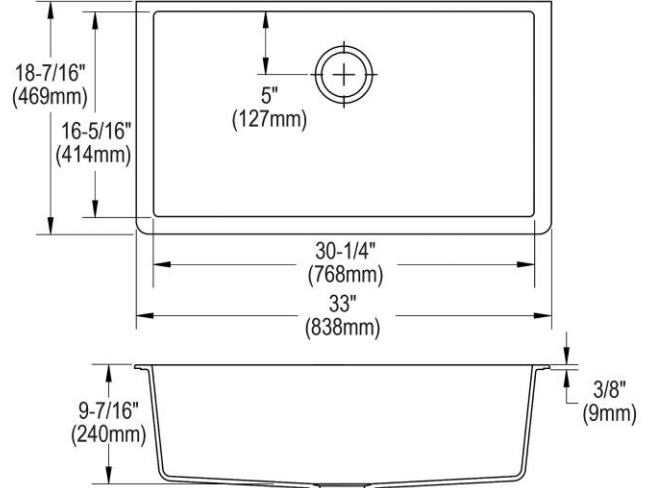







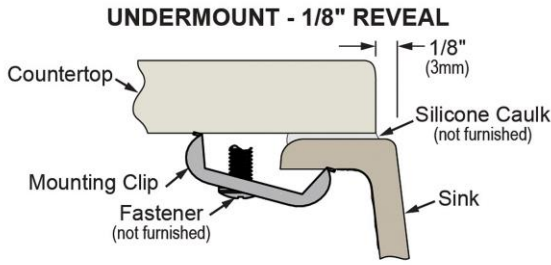

PART: \_\_\_\_\_ QTY: \_\_\_\_\_  
 PROJECT: \_\_\_\_\_  
 CONTACT: \_\_\_\_\_  
 DATE: \_\_\_\_\_  
 NOTES: \_\_\_\_\_  
 APPROVAL: \_\_\_\_\_

In keeping with our policy of continuing product improvement, Elkay reserves the right to change product specifications without notice. Please visit [elkay.com](#) for the most current version of Elkay product specification sheets. This specification describes an Elkay product with design, quality, and functional benefits to the user. When making a comparison of other producers' offerings, be certain these features are not overlooked. Latest version of the spec sheet available: [https://www.elkayfiles.com/spec-sheets/ELXRU13322\\_spec.pdf](https://www.elkayfiles.com/spec-sheets/ELXRU13322_spec.pdf)

**Installation Profile:**



Designed to affix to the underside of any solid surface countertop.

Optional Accessories		
<a href="#">LKOBG2915SS</a>	Elkay® Stainless Steel 27-1/2" x 13-1/2" x 1-1/4" Bottom Grid <a href="#">Spec Sheet (PDF)</a>	
<a href="#">LK99</a>	Deluxe 3-1/2" Drain Type 304 Stainless Steel Body Strainer Basket Rubber Seal and Tailpiece <a href="#">Spec Sheet (PDF)</a>	
<a href="#">LKQD35</a>	Polymer 3-1/2" Disposer Flange with Removable Basket Strainer and Rubber Stopper <a href="#">Spec Sheet (PDF)</a>	
<a href="#">LKQS35</a>	Elkay® Polymer 3-1/2" Drain Fitting with Removable Basket Strainer and Rubber Stopper <a href="#">Spec Sheet (PDF)</a>	
<a href="#">LKEC2031</a>	Elkay Explore Single Hole Kitchen Faucet with Pull-down Spray and Forward Only Lever Handle <a href="#">Spec Sheet (PDF)</a>	
<a href="#">LK6000</a>	Elkay Everyday Single Hole Deck Mount Kitchen Faucet with Pull-down Spray Forward Only Lever Handle <a href="#">Spec Sheet (PDF)</a>	
<a href="#">LKQD35</a>	Polymer 3-1/2" Disposer Flange with Removable Basket Strainer and Rubber Stopper <a href="#">Spec Sheet (PDF)</a>	
<a href="#">LKQS35</a>	Elkay® Polymer 3-1/2" Drain Fitting with Removable Basket Strainer and Rubber Stopper <a href="#">Spec Sheet (PDF)</a>	

In keeping with our policy of continuing product improvement, Elkay reserves the right to change product specifications without notice. Please visit [elkay.com](http://elkay.com) for the most current version of Elkay product specification sheets. This specification describes an Elkay product with design, quality, and functional benefits to the user. When making a comparison of other producers' offerings, be certain these features are not overlooked. Latest version of the spec sheet available: [https://www.elkayfiles.com/spec-sheets/ELXRU13322\\_spec.pdf](https://www.elkayfiles.com/spec-sheets/ELXRU13322_spec.pdf)