

PRODUCT SPECIFICATIONS

Elkay Crosstown® 18 Gauge Workstation Stainless Steel 28-1/2" x 18-1/2" x 8-1/2" Single Bowl Undermount Sink Kit. Sink is manufactured from 18 gauge 304 Stainless Steel with a Polished Satin finish, Rear Right drain placement, and Full spray sides and bottom with Sides and Bottom pads.

Installation Type:	Undermount
Material:	304 Stainless Steel
Special Features:	Workstation
Finish:	Polished Satin
Gauge:	18
Sound Deadening:	Full spray sides and bottom with Sides and Bottom pads
Number of Bowls:	1
Sink Dimensions:	28-1/2" x 18-1/2" x 9"
Bowl 1 Dimensions:	9" x 17" x 9"
Drain Size:	3-1/2" (89mm)
Drain Location:	Rear Right
Minimum Cabinet Size:	30"
Mounting Hardware:	Yes
Template Included:	Yes
Cutout Template #:	2000000622

Template is available for download at [elkay.com](#). CAD software will be required to open the template.

Hole Drilling Configurations:

Installation Profile:

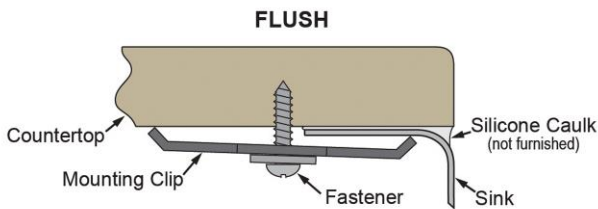

Designed to affix to the underside of any solid surface countertop.

PART: _____ QTY: _____

PROJECT: _____

CONTACT: _____

DATE: _____

NOTES: _____

APPROVAL: _____



Included with Product: LKDD Drain, CTXBG2514 Bottom Grid, LKCB1217AC Cutting Board, LKC0717SS Colander, LKDR13174RU Roll-up Drying Rack, LKDR0717SS Drying Rack

A Century of Tradition and Quality.

For more than 100 years, Elkay has been making innovative products and providing exceptional customer care. We take pride in offering plumbing products that make life easier, inspire change and leave the world a better place.

Product Compliance: ASME A112.19.3/CSA B45.4

[Clean and Care Manual \(PDF\)](#)

[Installation Instructions \(PDF\) - 1000005239](#)





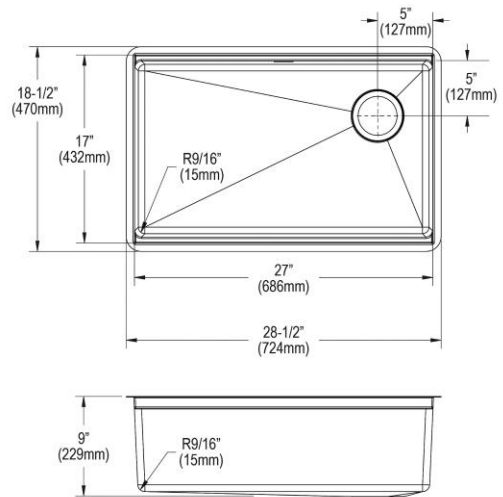

[Installation Instructions \(PDF\) - 1000005235 drain](#)



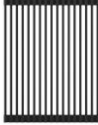

[Installation Instructions \(PDF\) -](#)

[Warranty \(PDF\)](#)



In keeping with our policy of continuing product improvement, Elkay reserves the right to change product specifications without notice. Please visit [elkay.com](#) for the most current version of Elkay product specification sheets. This specification describes an Elkay product with design, quality, and functional benefits to the user. When making a comparison of other producers' offerings, be certain these features are not overlooked.

Included Accessories		
LKDD	Elkay 3-1/2" Drain Fitting Deep Strainer Basket Spec Sheet (PDF)	
CTXBG2514	Elkay Crosstown Stainless Steel 25-1/8" x 14-1/4" x 1-1/8" Bottom Grid Spec Sheet (PDF)	
LKCB1217AC	Elkay Acacia Hardwood 12" x 16-7/8" x 1" Cutting Board Spec Sheet (PDF)	
LKC0717SS	Elkay Crosstown Stainless Steel 16-7/8" x 6-3/4" x 3-1/8" Colander with Wood Handles Spec Sheet (PDF)	
LKDR1317RU	Elkay Crosstown Black Silicone 11-7/8" x 16-3/4" x 3/8" Drying Rack Spec Sheet (PDF)	
LKDR0717SS	Elkay Crosstown Stainless Steel 16-7/8" x 6-3/4" x 4-1/4" Drying Rack with Wood Handles Spec Sheet (PDF)	

Optional Accessories		
CTXBG2514	Elkay Crosstown Stainless Steel 25-1/8" x 14-1/4" x 1-1/8" Bottom Grid Spec Sheet (PDF)	
LKC0717SS	Elkay Crosstown Stainless Steel 16-7/8" x 6-3/4" x 3-1/8" Colander with Wood Handles Spec Sheet (PDF)	
LKCB1217AC	Elkay Acacia Hardwood 12" x 16-7/8" x 1" Cutting Board Spec Sheet (PDF)	
LKDD	Elkay 3-1/2" Drain Fitting Deep Strainer Basket Spec Sheet (PDF)	

In keeping with our policy of continuing product improvement, Elkay reserves the right to change product specifications without notice. Please visit elkay.com for the most current version of Elkay product specification sheets. This specification describes an Elkay product with design, quality, and functional benefits to the user. When making a comparison of other producers' offerings, be certain these features are not overlooked.

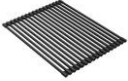
LKAV2061	Elkay Avado Single Hole Kitchen Faucet with Semi-professional Spout and Lever Handle Spec Sheet (PDF)	
LKDR1317RU	Elkay Crosstown Black Silicone 11-7/8" x 16-3/4" x 3/8" Drying Rack Spec Sheet (PDF)	

In keeping with our policy of continuing product improvement, Elkay reserves the right to change product specifications without notice. Please visit elkay.com for the most current version of Elkay product specification sheets. This specification describes an Elkay product with design, quality, and functional benefits to the user. When making a comparison of other producers' offerings, be certain these features are not overlooked.