

PRODUCT SPECIFICATIONS

Elkay Quartz Classic® 33" x 18-1/2" x 9-1/2", Equal Double Bowl Undermount Sink Kit with Filtered Faucet. Sink is molded with up to 80% natural quartz and high performance acrylic resins that are non-porous providing superior heat, scratch, fade and stain resistance. Naturally sound deadening and Rear Center drain placement.



Installation Type:	Sink Kits, Undermount
Material:	Quartz
Finish:	Black (BK), Greystone (GS), Mocha (MC), White (WH)
Number of Bowls:	2
Sink Dimensions:	33" x 18-1/2" x 9-1/2"
Bowl 1 Dimensions:	14-1/4" x 16-3/16" x 9-1/2"
Bowl 2 Dimensions:	14-1/4" x 16-3/16" x 9-1/2"
Drain Size:	3-5/8" (92mm)
Drain Location:	Rear Center
Minimum Cabinet Size:	36"
Mounting Hardware:	Included
Template Included:	Yes
Cutout Template #:	1000003496

Template is available for download at [elkay.com](#). CAD software will be required to open the template.

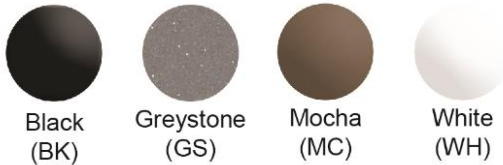

Included with Product: LKAV7051FCR Faucet with filter included, LKQS35 Drain, LKQD35 Drain, two LKOBG1516SS Bottom Grids

AMERICAN PRIDE. A LIFETIME TRADITION.
Like your family, the Elkay family has values and traditions that endure. For almost a century, Elkay has been a family-owned and operated company, providing thousands of jobs that support our families and communities.

Product Compliance: CSA B45.5/IAPMO Z124
Faucet: ASME A112.18.1/CSA B125.1
NSF 61
NSF 372 (lead free)
Accessory: ASME A112.18.2/CSA B125.2
NSF 42
NSF 53

Installation Profile:

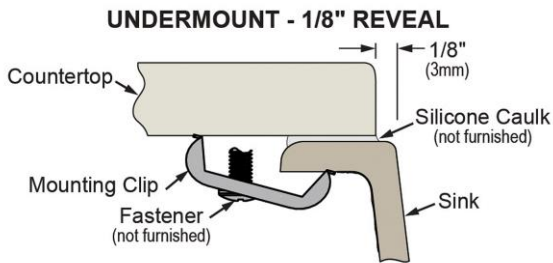

Designed to affix to the underside of any solid surface countertop.



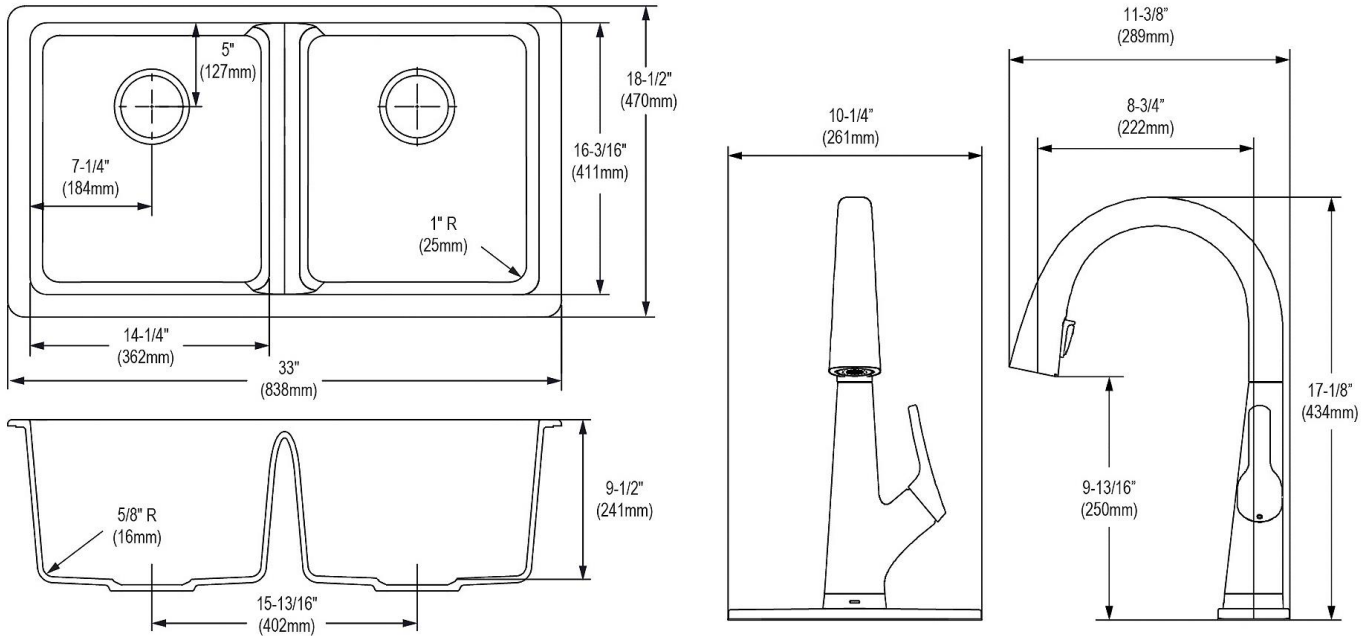

[Clean and Care Manual \(PDF\)](#)
[Installation Instructions \(PDF\)](#)
[Warranty \(PDF\)](#)

PART: _____ QTY: _____
PROJECT: _____
CONTACT: _____
DATE: _____
NOTES: _____
APPROVAL: _____

In keeping with our policy of continuing product improvement, Elkay reserves the right to change product specifications without notice. Please visit [elkay.com](#) for the most current version of Elkay product specification sheets. This specification describes an Elkay product with design, quality, and functional benefits to the user. When making a comparison of other producers' offerings, be certain these features are not overlooked.



Optional Accessories

<p>LKCBEG1516HW</p>	<p>Elkay Hardwood 15-5/16" x 17-3/16" x 1" Cutting Board Spec Sheet (PDF)</p>	
<p>LK99</p>	<p>Elkay Deluxe 3-1/2" Drain Type 304 Stainless Steel Body Strainer Basket Rubber Seal and Tailpiece Spec Sheet (PDF)</p>	
<p>LKWRB1516SS</p>	<p>Elkay Stainless Steel 11-7/8" x 13-13/16" x 6-15/16" Rinsing Basket Spec Sheet (PDF)</p>	
<p>ERF750</p>	<p>Elkay 750-gallon Residential Replacement Filter Spec Sheet (PDF)</p>	

In keeping with our policy of continuing product improvement, Elkay reserves the right to change product specifications without notice. Please visit elkay.com for the most current version of Elkay product specification sheets. This specification describes an Elkay product with design, quality, and functional benefits to the user. When making a comparison of other producers' offerings, be certain these features are not overlooked.