

PRODUCT SPECIFICATIONS

Elkay Quartz Classic[®] 32-1/2" x 20" x 10", 60/40 Double Bowl Undermount Sink. Sink is molded with up to 80% natural quartz and high performance acrylic resins that are non-porous providing superior heat, scratch, fade and stain resistance. Naturally sound deadening and Rear Center drain placement.



Installation Type:	Undermount
Material:	Quartz
Finish:	Bisque (BQ), Black (BK), Dusk Gray (GY), Greige (GR), Greystone (GS), Mocha (MC), Putty (PT), White (WH)
Number of Bowls:	2
Sink Dimensions:	32-1/2" x 20" x 10"
Bowl 1 Dimensions:	17-9/16" x 17-3/4" x 10"
Bowl 2 Dimensions:	11-1/2" x 16-13/16" x 10"
Drain Size:	3-1/2" (89mm)
Drain Location:	Rear Center
Minimum Cabinet Size:	36"
Mounting Hardware:	Part # 54300408 included
Template Included:	Yes
Cutout Template #:	1000003464

Template is available for download at [elkay.com](#). CAD software will be required to open the template.

AMERICAN PRIDE. A LIFETIME TRADITION.

Like your family, the Elkay family has values and traditions that endure. For almost a century, Elkay has been a family-owned and operated company, providing thousands of jobs that support our families and communities.

Product Compliance: CSA B45.5/IAPMO Z124



Sinks are listed by IAPMO[®] as meeting the applicable requirements of the Uniform Plumbing Code[®], International Plumbing Code[®], and National Plumbing Code of Canada.

[Clean and Care Manual \(PDF\)](#)
[Installation Instructions \(PDF\)](#)
[Warranty \(PDF\)](#)

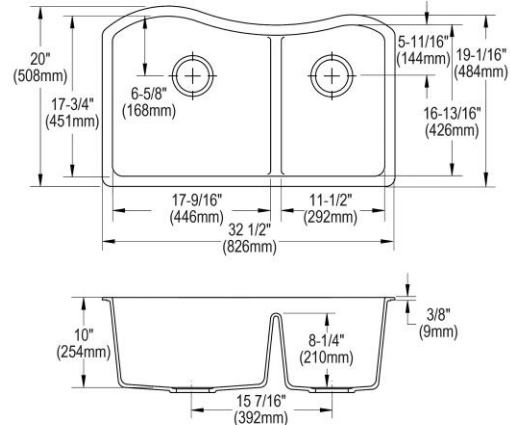



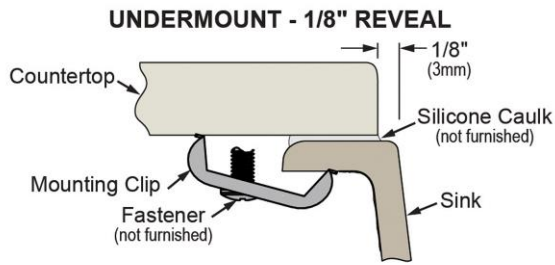

PART: _____ QTY: _____
 PROJECT: _____
 CONTACT: _____
 DATE: _____
 NOTES: _____
 APPROVAL: _____

In keeping with our policy of continuing product improvement, Elkay reserves the right to change product specifications without notice. Please visit [elkay.com](#) for the most current version of Elkay product specification sheets. This specification describes an Elkay product with design, quality, and functional benefits to the user. When making a comparison of other producers' offerings, be certain these features are not overlooked.

Installation Profile:



Designed to affix to the underside of any solid surface countertop.

Optional Accessories		
LKOBG1016SS	Elkay Stainless Steel 9-5/8" x 14-5/8" x 1" Bottom Grid Spec Sheet (PDF)	
LKOBG1617SS	Elkay Stainless Steel 15-11/16" x 15-1/2" x 1" Bottom Grid Spec Sheet (PDF)	
LK99	Elkay Deluxe 3-1/2" Drain Type 304 Stainless Steel Body, Strainer Basket Rubber Seal and Tailpiece Spec Sheet (PDF)	
LKQD35	Elkay Polymer 3-1/2" Disposer Flange with Removable Basket Strainer and Rubber Stopper Spec Sheet (PDF)	
LKQS35	Elkay Polymer 3-1/2" Drain Fitting with Removable Basket Strainer and Rubber Stopper Spec Sheet (PDF)	

In keeping with our policy of continuing product improvement, Elkay reserves the right to change product specifications without notice. Please visit elkay.com for the most current version of Elkay product specification sheets. This specification describes an Elkay product with design, quality, and functional benefits to the user. When making a comparison of other producers' offerings, be certain these features are not overlooked.