



HUSH SYSTEM



LED REPLACEABLE



SEAMLESS LOOK



GREASE COLLECTORS



PROFESSIONAL PERFORMANCE



HEAT GUARD

ELICA'S EXCLUSIVE PLUS FEATURES

Arezzo provides professional grade performance, while being discreetly mounted inside the cabinetry.

Available in 28 1/2" and 34 1/2" width with a 600 CFM blower, and equipped with a 1200 CFM blower for widths of 34 1/2", 40 1/2" and 46 1/2" for extraordinary ventilating power.

The extra depth (22") is ideal for supporting powerful professional ranges. Plus the All-In-One design avoids the need to purchase a stainless liner. Hidden metallic in/out knob controls operate the 4-speed blower and LED lighting.

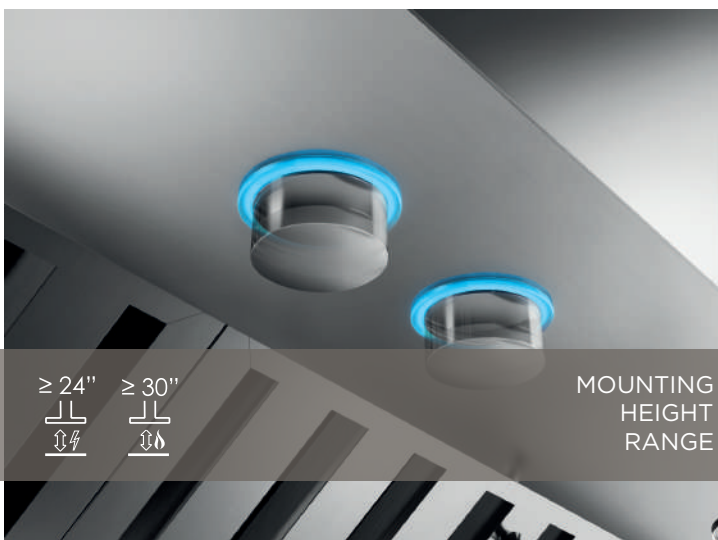
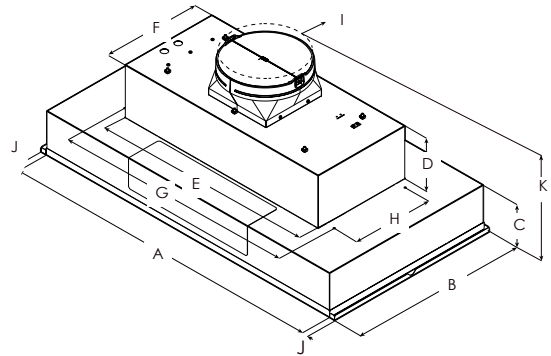

≥ 24"
↓
↑







≥ 30"
↓
↑

MOUNTING
HEIGHT
RANGE

	EAR634SS			
	EAR628S4	EAR134S4	EAR140S4	EAR146S4
A	28 1/2" (72.4 cm)	34 1/2" (87.6 cm)	40 1/2" (103 cm)	46 1/2" (118 cm)
B	22" (55.9 cm)	22" (55.9 cm)	22" (55.9 cm)	
C	5 7/16" (13.8 cm)			
D	6 1/2" (16.4 cm)			
E	22 3/4" (56 cm)	27 1/6" (70 cm)		
F	12 3/8" (31.6 cm)			
G	24 3/4" (62 cm)	29 13/16" (31.6 cm)		
H	10 1/8" (25.7 cm)			
I	10" (25.4 cm)			
J	3/4" (1.9 cm)			
K	16 11/16" (42.3 cm)			

Width:	28" Unit	34" Unit	40" Unit	46" Unit
Model:	EAR628S4	EAR634SS* (600 CFM) EAR134S4** (1200 CFM)	EAR140S4	EAR146S4
Dimensions:	28 1/2"W x 22"D x 11 7/8"H	34 1/2"W x 22"D x 11 7/8"H	40 1/2"W x 22"D x 11 7/8"H	46 1/2"W x 22"D x 11 7/8"H
Blower Type(internal):**	600 CFM(4-speed)	600 CFM (4-speed)* 1200 CFM (4-speed)**	1200 CFM(4-speed)	
Noise (sones):**	7 Sones	7 Sones** 8.5 Sones**	8.5 Sones	
Finish:	Stainless Steel			
Controls:	Fully Retractable Rotating Knobs with Blue Backlight			
Illumination:	2 LED, 6.5 W, 3000 K, 540 Lumen		4 LED, 6.5 W, 3000 K, 540 Lumen	
Grease Filter:	Dishwasher-Safe, Professional Stainless Steel Baffle Filters 2 for 28", 34", 40" & 3 for 46"			
Duct Transition:	10" Round with BackDraft Damper (top only)			
Installation Type:	Ducted Installation Only			
Electrical:	120V - 60Hz, 463W	120V - 60 Hz, 490 W* 120V - 60 Hz, 913 W**	120V - 60 Hz, 926 W	
KITS:				
1200 CFM External Blower Kit:	KIT0153054			
1200 CFM Inline Blower Kit:	KIT0154387			
Inline Blower Shell Kit:	KIT0179549 (for use with 1200 CFM blowers only)			
External Blower Shell Kit:	KIT0179547 (for use with 1200 CFM blowers only)			
Electronic CFM Reduction Bypass KIT:	KIT0185752 (for 600 CFM Blower), KIT0185099(for 1200 CFM Blower)			
WARRANTY:***	Two (2) Years Parts & In-Home Labor. Earn an additional One (1) Year of Parts & In-Home Labor by registering on elica.com.			

PLUS FEATURES

- 
HUSH SYSTEM - An exclusive sound deadening technology that effectively reduces sound levels by over 35%
- 
LED CONSUMER REPLACEABLE BULB - High quality LED lighting usually requires a skilled technician to replace lamps. Avoid this expense with Elica's new LED lamps that enable homeowners to replace in seconds
- 
SEAMLESS CRAFTSMANSHIP - Heavy gauge stainless steel "Seamless" construction that delivers refined elegance.
- 
STAINLESS STEEL BAFFLE FILTERS WITH GREASE COLLECTORS - Designed for high airflow cooking, the "S" shape design traps high volumes of grease
- 
PROFESSIONAL PERFORMANCE - Special features and high performances for models with aspiration capacity between 600 and 1200 CFM's
- 
HEAT GUARD - Senses extreme temperatures (>158° F) and automatically adjusts the blower speed to HIGH



Model	Certified Ratings	High Speed	Working Speed	Duct Size
EAR628S4	CFM	500	180	10" (Vertical)
EAR634SS	Sones	9.5	2	10" (Vertical)
EAR134S4	CFM	860	320	10" (Vertical)
EAR140S4	Sones	12.5	2	10" (Vertical)
EAR146S4				

* The product images shown are for illustration purposes only and may not be an exact representation of the product.

** Blower performance indicates the performance of the blower by itself. Performance claims are not AHAM certified but were established in accordance with HVI Standardized test procedure. For Certified Ratings, please refer to AHAM Certified Product Directory. Electric Ratings are declared according to UL.

*** For valid warranty extension, register within 3 months from purchase. For USA & Canada Users Only.