

Collection:Fletcher
 Installation manual for:

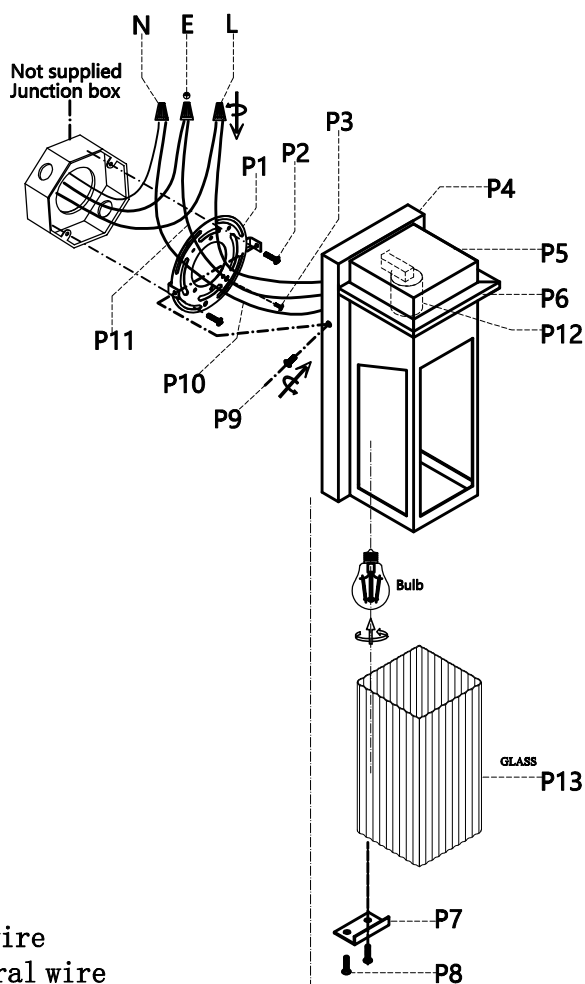

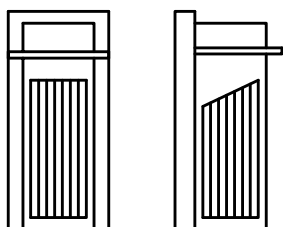









OD364W11BK W5" H11" E5.5" L1

Installation instructions:

- 1.Install E26 light source.(Bulbs not supplied).
- 2.Instal galss (P13) into lamp body(P5) and use clips(P7) with screw(P8) to fix glass.
3. Use screw(P2) to fix lamp with wall mounted
- 4.Secure mounting bracket(P1) to the junction box.
- 5.Black wire from ceiling(junction box) attaches to "L"wire from the fixture
- 6.White wire from ceiling(junction box) attaches to "N"wire from the fixture
- 7."E" wire from the ceiling attaches to "E" wire from the fixture.
- 8.Install the lamp body to the mounting bracket by screws(P9)



"L" = Hot wire
 "N" = Neutral wire
 "E" = Ground wire

Part Number	Part	Picture	Description	Qty
MB12W01	P1		Mounting bracket Ø3.94	1
	P2		Mounting bracket screw M4	2
	P3		Screw M4	1
P-OD364W11BK-1	P4		L277*W127*H25MM Box	1
	P5		L90*W90*H262MM Body	1
	P6		L127*W110*H8MM Square parts	1
	P7		L50*W25*H10mm Clips	1
	P8		Screw M4	2
	P9		Screw M4	2
	P10		UL18#, L12"Black+White	1
	P11		UL18#Ground wire, L9. 8"	1
	P12		E26 Holder	1
GS12L30	P13		L85*W85*H200mm Glass	1