

Collection: Dunton









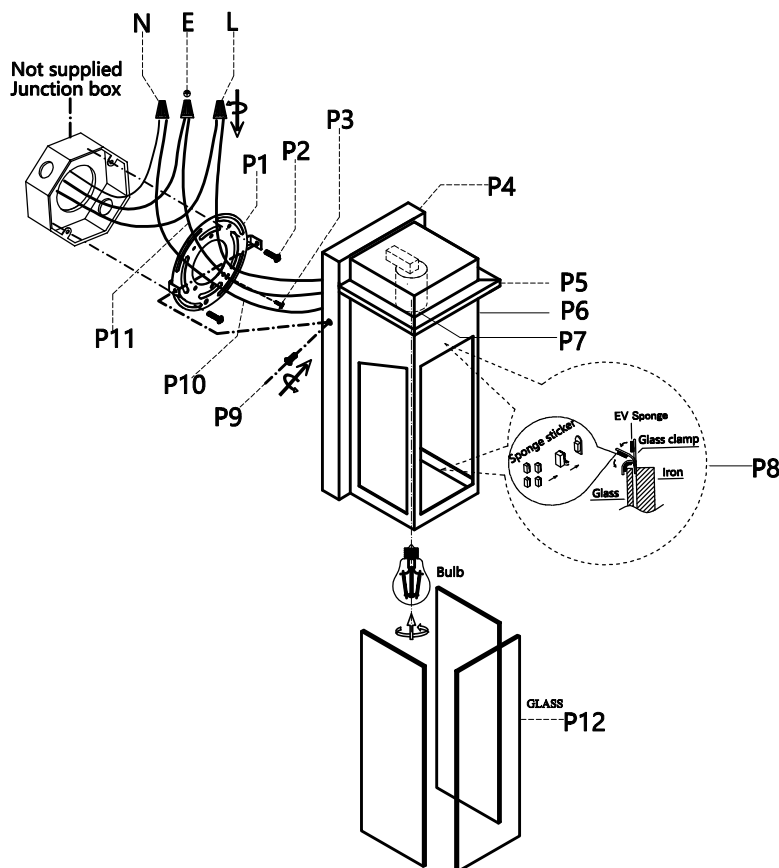
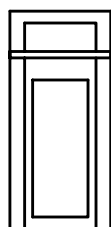



Installation manual for:

OD362W11BK W5" H11" E5.5" L1

Installation instructions:

1. Install E26 light source.(Bulbs not supplied) .
2. Put glass(P12)into body(P6) and stick sponge on clips(P8).Finally curve clips to fix glass.
3. Secure mounting bracket to the junction box.
4. Black wire from ceiling(junction box) attaches to "L"wire from the fixture
5. White wire from ceiling(junction box) attaches to "N"wire from the fixture
6. "E" wire from the ceiling attaches to "E" wire from the fixture.
7. Install the lamp body to the mounting bracket by screws(P9)



Part Number	Part	Picture	Description	Qty
MB12W01	P1		Mounting bracket Ø3.94	1
	P2		Mounting bracket screw M4	2
	P3		Screw M4	1
P-OD362W11BK-1	P4		L277*W127*H25MM Back plate	1
	P5		L127*W110*H8MM Square parts	1
	P6		L90*W90*H262MM Body	1
	P7		E26 Holder	1
	P8		EV Sponge Sponge sticker	3
	P9		Screw M4	2
	P10		UL18#, L12" Black+White	1
	P11		UL18#Ground wire, L9. 8"	1
GP12L31	P12		L195xW80xT3. 0mm Glass	3

"L" = Hot wire
 "N" = Neutral wire
 "E" = Ground wire