

Collection: Eyre









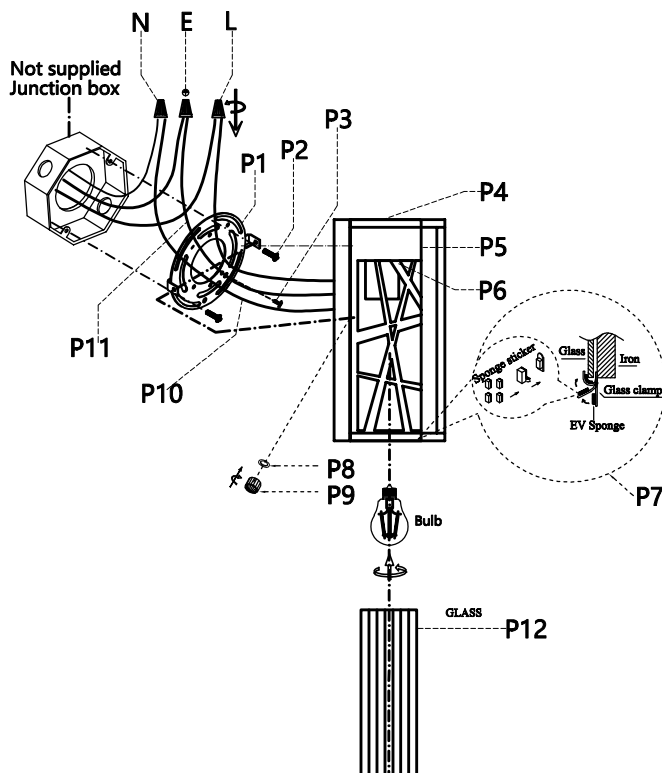
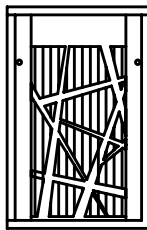



Installation manual for:

OD356W12BK W7" H11.5" E6" L1

Installation instructions:

1. Install E26 light source. (Bulbs not supplied)
2. Put glass (P12) into body (P5) and stick sponge on clips (P7). Finally curve clips to fix glass.
3. Secure mounting bracket (P1) to the junction box.
4. Black wire from ceiling (junction box) attaches to "L" wire from the fixture
5. White wire from ceiling (junction box) attaches to "N" wire from the fixture
6. "E" wire from the ceiling attaches to "E" wire from the fixture.
7. Use rubber ring (P8) and screw (P9) to fixable lamp with wall mounted.



Part Number	Part	Picture	Description	Qty	
MB12W01	P1		Mounting bracket Ø3.94	1	
	P2		Mounting bracket screw M4	2	
	P3		Screw M4	1	
P-OD356W12BK-1	P4		280x180x140MM Back plate	1	
	P5		280x120x90MM Body	1	
	P6		E26 Lamp Holder	1	
	P7		EV Sponge Sticker	3	
	P8		Rubber ring	2	
	P9		Screw cap	2	
	P10		UL18#, L12" Black+White	1	
	P11		UL18# Ground wire, L9.8"	1	
	GS12L22	P12		115x82x245MM Glass	1

"L" = Hot wire
 "N" = Neutral wire
 "E" = Ground wire