

Collection: Woodstock
Installation manual for:

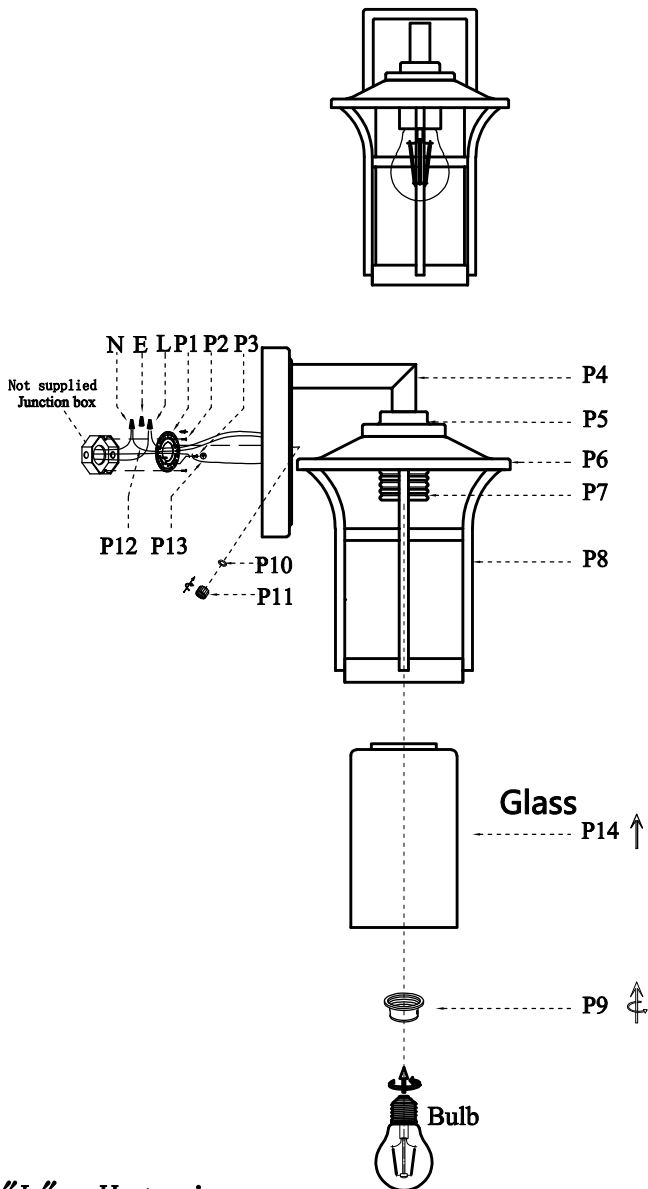













OD345W11BK W7" H11" E8" L1

Installation instructions:

1. Install glass (P14) to body (P8).
2. Use socket ring (P9) to lock in glass (P14).
3. Install E26 light source. (Bulbs not supplied).
4. Secure mounting bracket to the junction box
5. Black wire from ceiling (junction box) attaches to "L" wire from the fixture
6. White wire from ceiling (junction box) attaches to "N" wire from the fixture
7. "E" wire from the ceiling attaches to "E" wire from the fixture.
8. Use rubber ring (P10) and screw cap (P11) fixable lamp into wall mounted



"L" = Hot wire
"N" = Neutral wire
"E" = Ground wire

Part Number	Part	Picture	Description	Qty
MB12W01	P1		Mounting bracket Ø3.94	1
	P2		Mounting bracket screw M4	2
	P3		Screw M4	1
P-OD345W11BK-1	P4		160*130*115MM Arm	1
	P5		70*70*18MM Box	1
	P6		180*180*28MM Cover	1
	P7		E26 Lamp Holder	1
	P8		174*174*196MM Body	1
	P9		Socket ring	1
	P10		Rubber ring	2
	P11		Screw cap	2
	P12		UL18#Ground wire, L9.8"	1
	P13		UL18#, L12" Black+White	1
GS12L18	P14		90*90*180MM Glass	1