

Collection: Janney









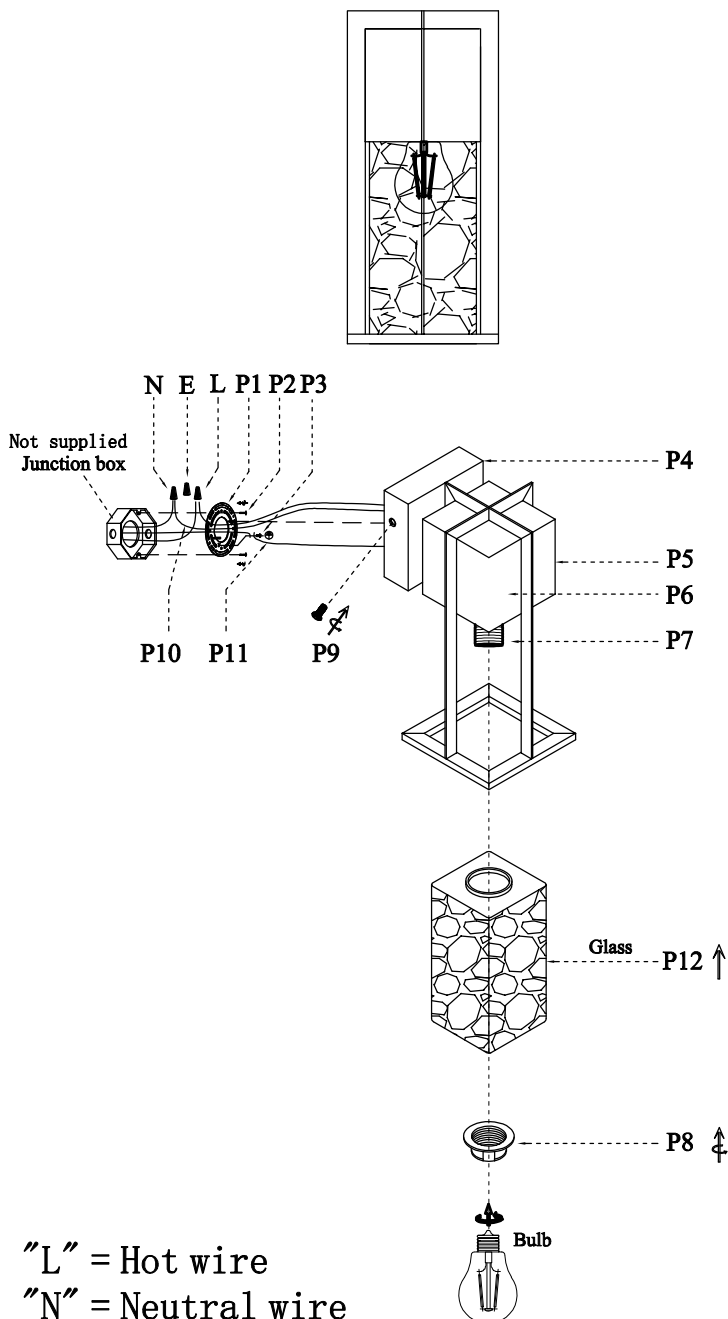



Installation manual for:

OD340W12BK W5" H11.5" E6.5" L1

**Installation instructions:**

1. Install E26 light source. (Bulbs not supplied) .
2. Instal galss (P12) into lamp body(P5) and use socket ring(P8) lock in.
3. Secure mounting bracket to the junction box.
4. Black wire from ceiling(junction box) attaches to "L" wire from the fixture
5. White wire from ceiling(junction box) attaches to "N" wire from the fixture
6. "E" wire from the ceiling attaches to "E" wire from the fixture.
7. Use screw(P9 ) to fixable lamp with wall mounted



| Part Number    | Part | Picture                                                                               | Description                  | Qty |
|----------------|------|---------------------------------------------------------------------------------------|------------------------------|-----|
| MB12W01        | P1   |  | Mounting bracket $\phi$ 3.94 | 1   |
|                | P2   |  | Mounting bracket screw M4    | 2   |
|                | P3   |  | Screw M4                     | 1   |
| P-OD340W12BK-1 | P4   |  | 110*110*35MM Back plate      | 1   |
|                | P5   |  | 127*127*280MM Body           | 1   |
|                | P6   |  | $\phi$ 60*30MM Box           | 1   |
|                | P7   |  | E26 Holder                   | 1   |
|                | P8   |  | Socket ring                  | 1   |
|                | P9   |  | Screw M4                     | 2   |
|                | P10  |  | UL18#Ground wire,L9.8"       | 1   |
|                | P11  |  | UL18#,L12"Black+White        | 1   |
| GS12L15        | P12  |  | 90*90*180MM Glass            | 1   |

"L" = Hot wire  
 "N" = Neutral wire  
 "E" = Ground wire