

Collection:Frankford









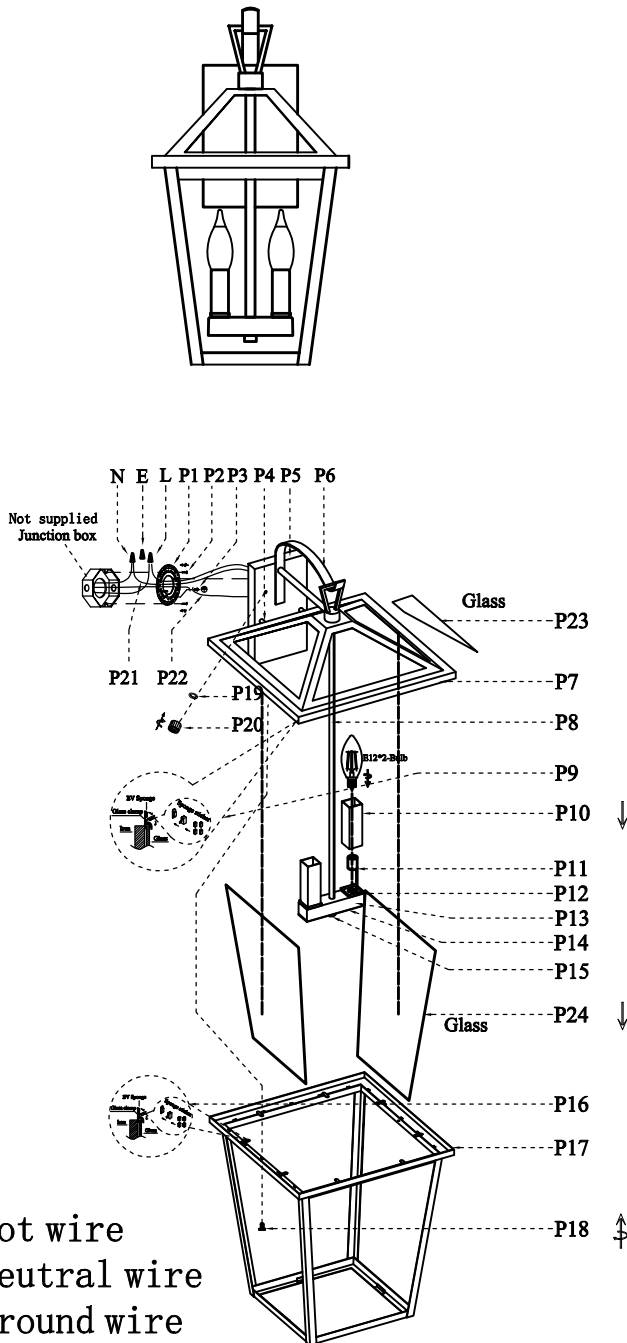















Installation manual for:

OD334W20BK W6.5" H15.5" E7.5" L1

**Installation instructions:**

- 1.Install tube(P10)on lamp holder
- 2.Install E12\*2 light source.(Bulbs not supplied) .
- 3.Put glass(P23)into Connect cover(P7) and stick sponge on clips(P9).Finally cruve clips to fix glass.
- 4.Put glass(P24)into into body(P17) and stick sponge on clips(P16).Finally cruve clips to fix glass.
- 5.Connect cover(P7)with body(P17) and with screw(P18) to fixable.
- 6.Secure mounting bracket to the junction box
- 7.Black wire from ceiling(junction box) attaches to "L"wire from the fixture
- 8.White wire from ceiling(junction box) attaches to "N"wire from the fixture
- 9."E" wire from the ceiling attaches to "E" wire from the fixture.
10. Use rubber ring(P19)and screw(P20) to fix lamp with wall mounted



Part Number	Part	Picture	Description	Qty
MB12W01	P1		Mounting bracket $\phi$ 3.94	1
	P2		Mounting bracket screw M4	2
	P3		Screw M4	1
P-OD334W20BK-1	P4		$\phi$ 8*20MM Tube	2
	P5		200*120*H25MM Box	1
	P6		171*205*55MM Ring	1
	P7		300*300*H100MM Cover	1
	P8		$\phi$ 11.5*340MM Tube	1
	P9		EV Sponge Sponge sticker	12
	P10		22*22*80MM Tube	2
	P11		E12 Holder	2
	P12		24*24*5MM Cover	2
	P13		107*28*23MM Box	1
	P14		105*26MM Plate	1
	P15		$\phi$ 15*H8MM Column parts	1
	P16		EV Sponge Sponge sticker	12
	P17		295*295*313MM Body	1
	P18		Screw M4	2
	P19		Rubber ring	2
	P20		Screw cap	2
	GP12L19	P21		UL18#Ground wire,L9.8"
P22			UL18#,L12"Black+White	1
P23			254*131MM Glass	4
P24			253*300MM Glass	4