

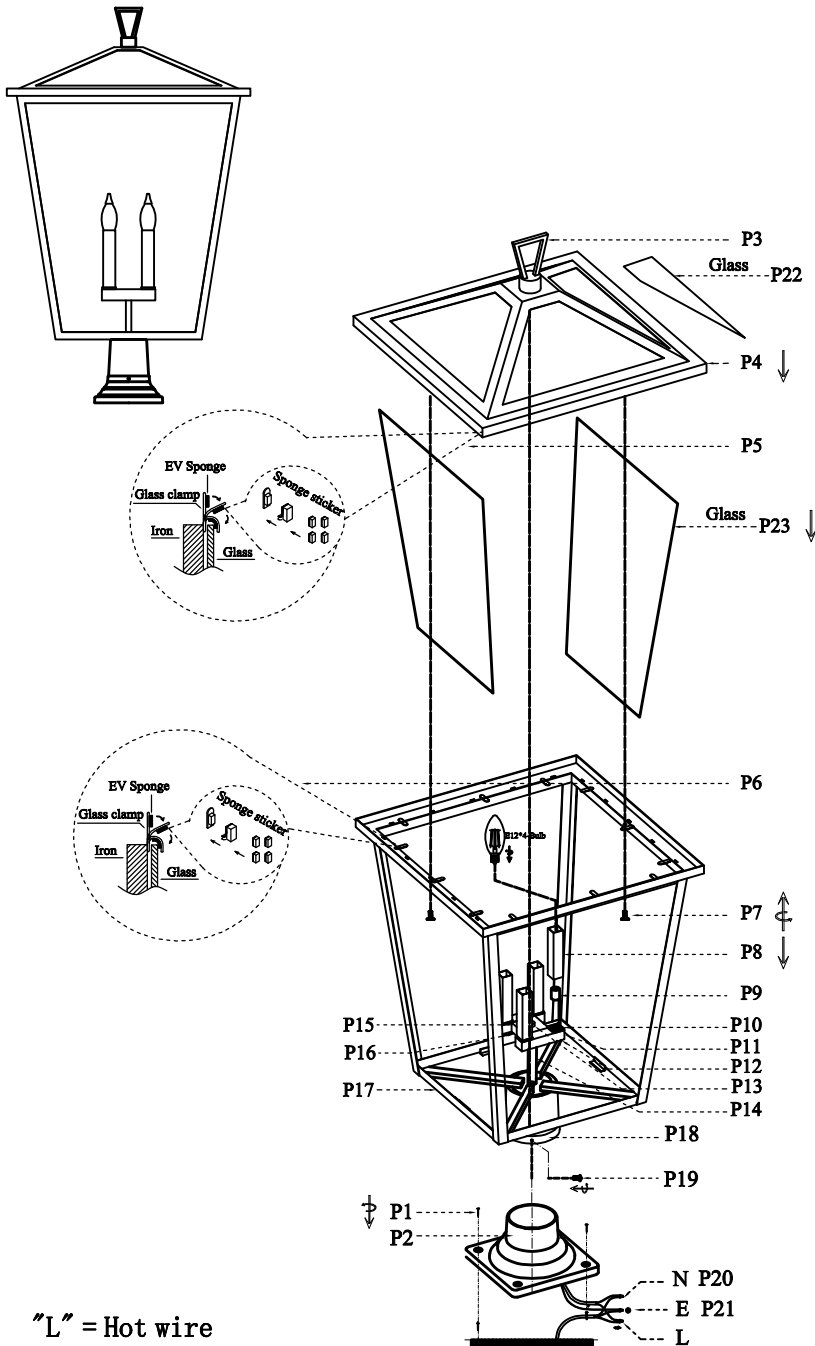





















Collection: Frankford  
 Installation manual for:  
 OD334P33BK L20" W20" H32.5" L4

**Installation instructions:**

1. Install tube(P8) on lamp holder
2. Install E12\*4 light source.(Bulbs not supplied) .
3. Put glass(P22)into cover(P4) and stick sponge on clips(P5).Finally cruve clips to fix glass.
4. Put glass(P23)into body(P17) and stick sponge on clips(P6).Finally cruve clips to fix glass.
5. Connect cover(P4)with body(P17) and put screw(P7) to fixable.
6. Black wire from ceiling(junction box) attaches to "L"wire from the fixture
7. White wire from ceiling(junction box) attaches to "N"wire from the fixture
8. "E" wire from the ceiling attaches to "E" wire from the fixture.
9. Use explosion screw (P1)to fix base(P2) into land.
10. Put lamp pole (P18) into base (P2)and use screw (P19) to lock in.



"L" = Hot wire  
 "N" = Neutral wire  
 "E" = Ground wire

LB12P01	P1	↑ ↑	Explosion screw M4	4
	P2		5.5"*2.95" Lamp base	1
P-OD334P33BK-1	P3		55*30*80MM Ring	1
	P4		500*500*H100MM Cover	1
	P5		EV Sponge Sponge sticker	16
	P6		EV Sponge Sponge sticker	16
	P7		Screw M4	8
	P8		22*22*100MM Tube	4
	P9		E12 Lamp Holder	4
	P10		24*24*5MM Cover	4
	P11		107*28*23MM Box	2
	P12		105*26MM Plate	2
	P13		∅15*H8MM Column cap	5
	P14		∅11.5*L80MM Tube	1
	P15		60*60*23MM Box	1
	P16		57*57*T1.2MM Plate	1
	P17		495*495*513MM Body	1
	P18		Lamp pole (3.38"*3.22")	1
	P19		Screws M4	3
	P20		UL18#Ground wire,L9.8"	1
	P21		UL18#,L12"Black+White	1
	GP12L21	P22		436*210MM Glass
P23			448*503MM Glass	4