

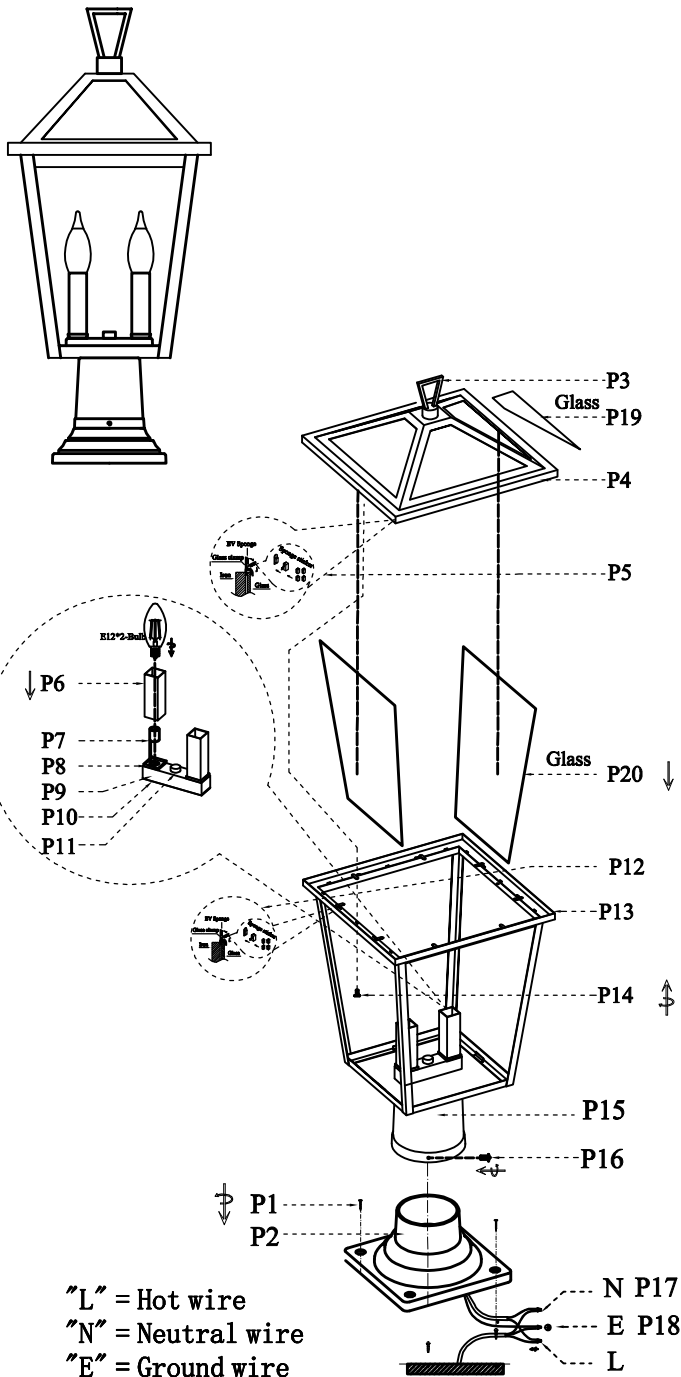



















Collection:Frankford
Installation manual for:
OD334P22BK L10" W10" H22" L2

Installation instructions:

1. Install tube(P6) on lamp holder
2. Install E12*2 light source.(Bulbs not supplied) .
3. Put glass(P9)into Connect cover(P4) and stick sponge on clips(P5).Finally cruve clips to fix glass.
4. Put glass(P20)into into body(P13) and stick sponge on clips(P12).Finally cruve clips to fix glass.
5. Connect cover(P4)with body(P13) and screw(P14) to fixable.
6. Black wire from ceiling(junction box) attaches to "L" wire from the fixture
7. White wire from ceiling(junction box) attaches to "N" wire from the fixture
8. "E" wire from the ceiling attaches to "E" wire from the fixture.
9. Use explosion screw to fix location and use explotion screw(P1) to screw base(P2).
10. Put lamp body into base(P2) and use screw in(P16)



LB12P01	P1	↑ ↑	Explosion screw M4	4	
	P2		5.5"*2.95" Lamp base	1	
P-OD334P22BK-1	P3		55*30*80MM Ring	1	
	P4		250*250*H100MM Cover	1	
	P5		EV Sponge Sponge sticker	12	
	P6		22*22*80MM Tube	2	
	P7		E12 Holder	2	
	P8		24*24*5MM Cover	2	
	P9		107*28*23MM Lamp Holder	1	
	P10		105*26MM Iron plate	1	
	P11		Ø15*H8MM Column	1	
	P12		EV Sponge Sponge sticker	12	
	P13		245*245*263MM Body	1	
	P14		Screw M4	2	
	P15		Lamp pole (3.38"*3.22")	1	
	P16		Screws M4	3	
	P17		UL18#Ground wire,L9.8"	1	
	P18		UL18#,L12"Black+White	1	
	GP12L18	P19		205*113MM Glass	4
		P20		203*249MM Glass	4