

Collection: Berks









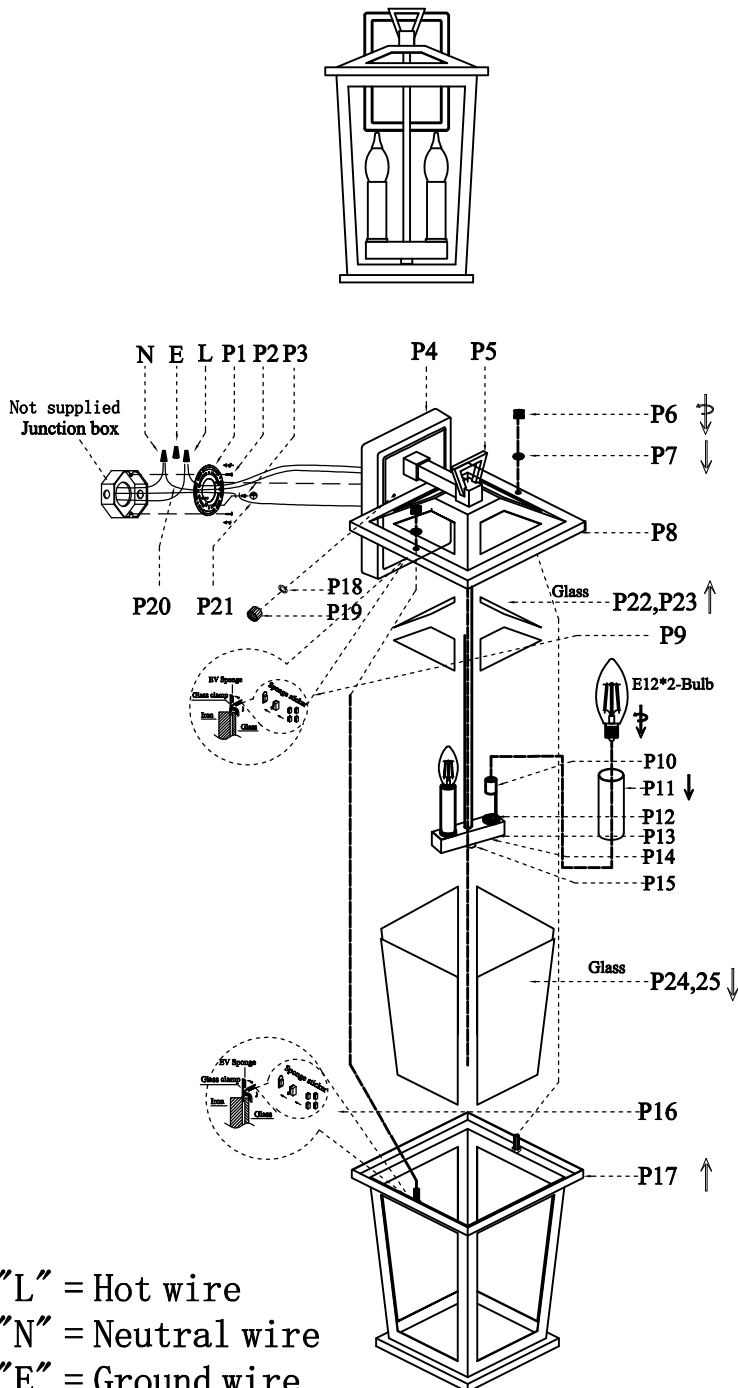















Installation manual for:

OD333W15BK W8.5" H14.5" E7" L2

Installation instructions:

1. Install tube(P11) on lamp holder
2. Install E12*2 light source.(Bulbs not supplied) .
3. Put glass(P22,P23)into Connect cover(P8) and stick sponge on clips(P9).Finally cruce clips to fix glass.
4. Put glass(P24,P25)into into body(P17) and stick sponge on clips(P16).Finally cruce clips to fix glass.
5. Connect cover(P8)with body(P17) and use rubber ring(P6) with screw caps to fixable.
6. Secure mounting bracket to the junction box
7. Black wire from ceiling(junction box) attaches to "L"wire from the fixture
8. White wire from ceiling(junction box) attaches to "N"wire from the fixture
9. "E" wire from the ceiling attaches to "E" wire from the fixture.
10. Use rubber ring(P18)and screw(P19) to fix lamp with wall mounted



Part Number	Part	Picture	Description	Qty	
MB12W01	P1		Mounting bracket Ø3.94	1	
	P2		Mounting bracket screw M4	2	
	P3		Screw M4	1	
P-OD333W15BK-1	P4		160*115*25MM Box	1	
	P5		85*50*50MM Ring	1	
	P6		Screw cap	2	
	P7		Rubber ring	2	
	P8		220*150*40MM Cover	1	
	P9		EV Sponge Sponge sticker	12	
	P10		E12 Holder	2	
	P11		Ø22*H80MM Tube	2	
	P12		Ø23*5MM Cover	2	
	P13		107*28*23MM Box	1	
	P14		105*26MM Plate	1	
	P15		Ø15*8MM Column parts	1	
	P16		EV Sponge Sponge sticker	16	
	P17		215*145*289MM Body	1	
	P18		Rubber ring	2	
	P19		Screw cap	2	
	P20		UL18#Ground wire,L9.8"	1	
	P21		UL18#,L12"Black+White	1	
	GP12L16	P22		110*73MM Glass	2
		P23		171*43MM Glass	2
		P24		108*266MM Glass	2
P25			178*266MM Glass	2	