

Collection: Berks

Installation manual for:







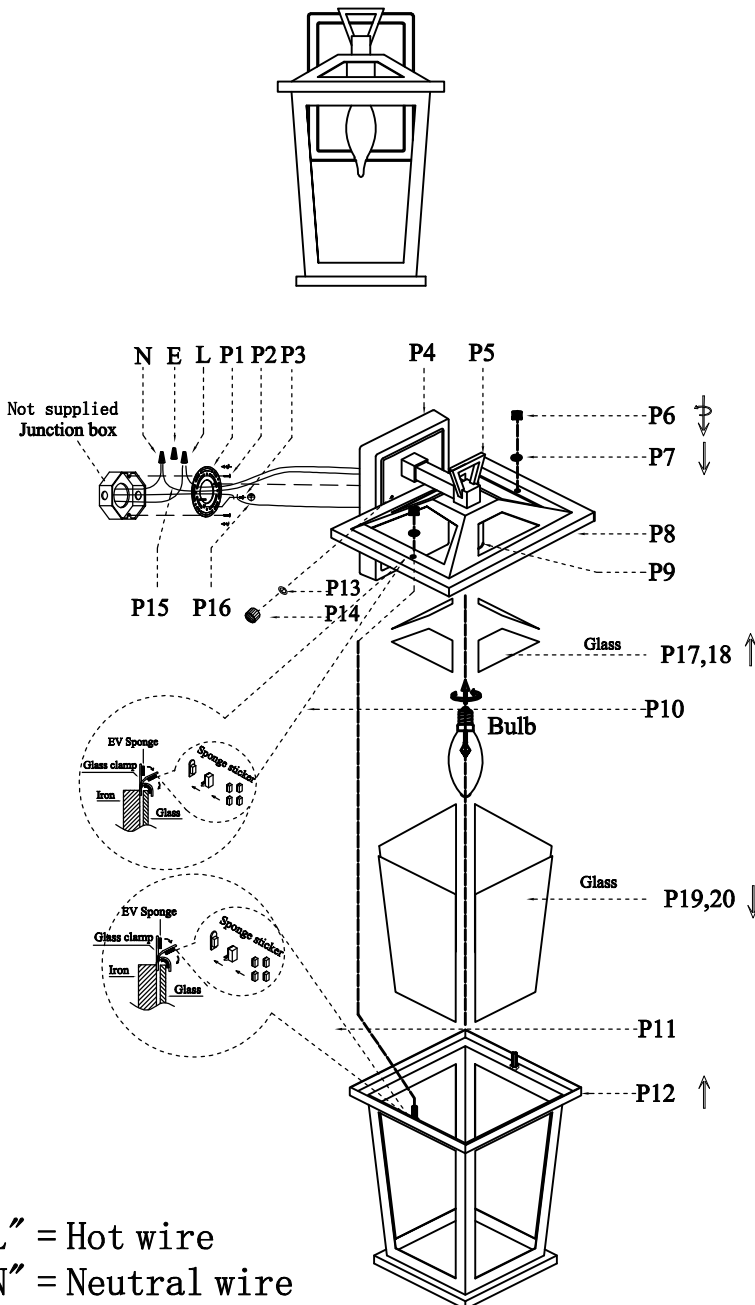













OD333W12BK W7" H12" E6.5" L1

**Installation instructions:**

1. Install E12 light source. (Bulbs not supplied) .
2. Put glass(P17,18) into cover(P8) and stick sponge on clips(P10). Finally curve clips to fix glass.
3. Put glass(P19,20) into body(P12) and stick sponge on clips(P11). Finally curve clips to fix glass.
4. Connect cover(P8) with body(P12) and put rubber ring(P7) and screw caps(P6) to fixable.
5. Secure mounting bracket(P1) to the junction box
6. Black wire from ceiling(junction box) attaches to "L" wire from the fixture
7. White wire from ceiling(junction box) attaches to "N" wire from the fixture
8. "E" wire from the ceiling attaches to "E" wire from the fixture.
9. Use rubber ring(P13) and screw(P14) to fixable lamp with wall mounted



"L" = Hot wire  
 "N" = Neutral wire  
 "E" = Ground wire

Part Number	Part	Picture	Description	Qty	
MB12W01	P1		Mounting bracket Ø3.94	1	
	P2		Mounting bracket screw M4	2	
	P3		Screw M4	1	
P-OD333W12BK-1	P4		160*115*25MM Back plate	1	
	P5		80*50*50MM Ring	1	
	P6		Screw cap	2	
	P7		Rubber ring	2	
	P8		180*140*H40MM Cover	1	
	P9		E12 Lamp Holder	1	
	P10		EV Sponge Sponge sticker	12	
	P11		EV Sponge Sponge sticker	12	
	P12		175*135*219MM Body	1	
	P13		Rubber ring	2	
	P14		Screw cap	2	
	P15		UL18# Ground wire, L9.8"	1	
	P16		UL18#, L12" Black+White	1	
	GP12L15	P17		99*56MM Glass	2
		P18		134*40MM Glass	2
		P19		137*196MM Glass	2
P20			98*197MM Glass	2	