

Collection: Cayman

Installation manual for:







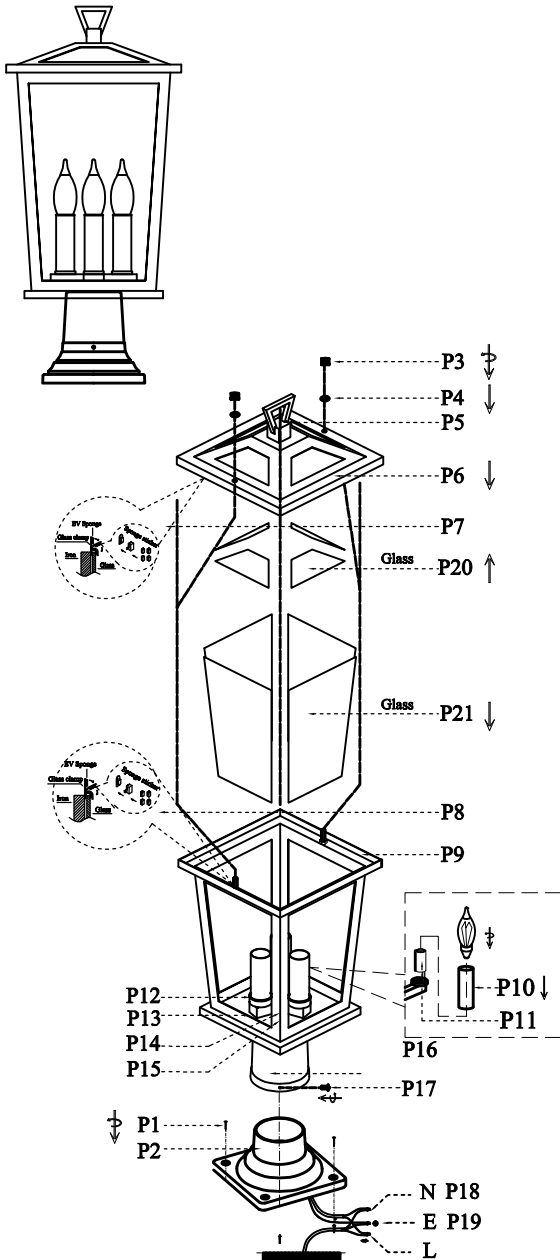







OD332P21BK L9.5" W9.5" H20.5" L3

**Installation instructions:**

1. Install tube(P10) on lamp holder
2. Install E12\*3 light source.(Bulbs not supplied) .
3. Put glass(P20) into Connect cover(P6) and stick sponge on clips(P7). Finally cruve clips to fix glass.
4. Put glass(P21) into body(P9) and stick sponge on clips(P8). Finally cruve clips to fix glass.
5. Connect cover(P6) with body(P9) and use rubber ring(P3) with screw caps to fixable.
6. Black wire from ceiling(junction box) attaches to "L" wire from the fixture
7. White wire from ceiling(junction box) attaches to "N" wire from the fixture
8. "E" wire from the ceiling attaches to "E" wire from the fixture.
9. Use explosion screw to fix location and use explotion screw(P1) to screw base(P2).
10. Put lamp body into base(P2) and use screw in(P17)



"L" = Hot wire  
"N" = Neutral wire  
"E" = Ground wire

Part Number	Part	Picture	Description	Qty	
LB12P01	P1	↑ ↑	Explosion screw M4	4	
	P2		5.5"*2.95" Lamp base	1	
P-OD332P21BK-1	P3	■	Screw cap	2	
	P4	●	Rubber ring	2	
	P5		50*50*20 Ring	1	
	P6		240*240*H40MM Cover	1	
	P7		EV Sponge Sponge sticker	12	
	P8		EV Sponge Sponge sticker	12	
	P9		235*235*319MM Body	1	
	P10		Ø22*H80MM Tube	3	
	P11		E12 Holder	3	
	P12	●	Ø23*5MM Cover	3	
	P13		120*74*23MM T-Box	1	
	P14		117*71MM T-Plate	1	
	P15	⊖	Ø15*8MM Column parts	1	
	P16		lamp pole (3.38"*3.22")	1	
	P17	⇒	Screws M4	3	
	P18		UL18#,L11.8"Black+White	1	
	P19		UL18#Ground wire,L9.8"	1	
	GP12L14	P20		196*82MM Glass	4
		P21		197*296MM Glass	4