

Collection: Cayman









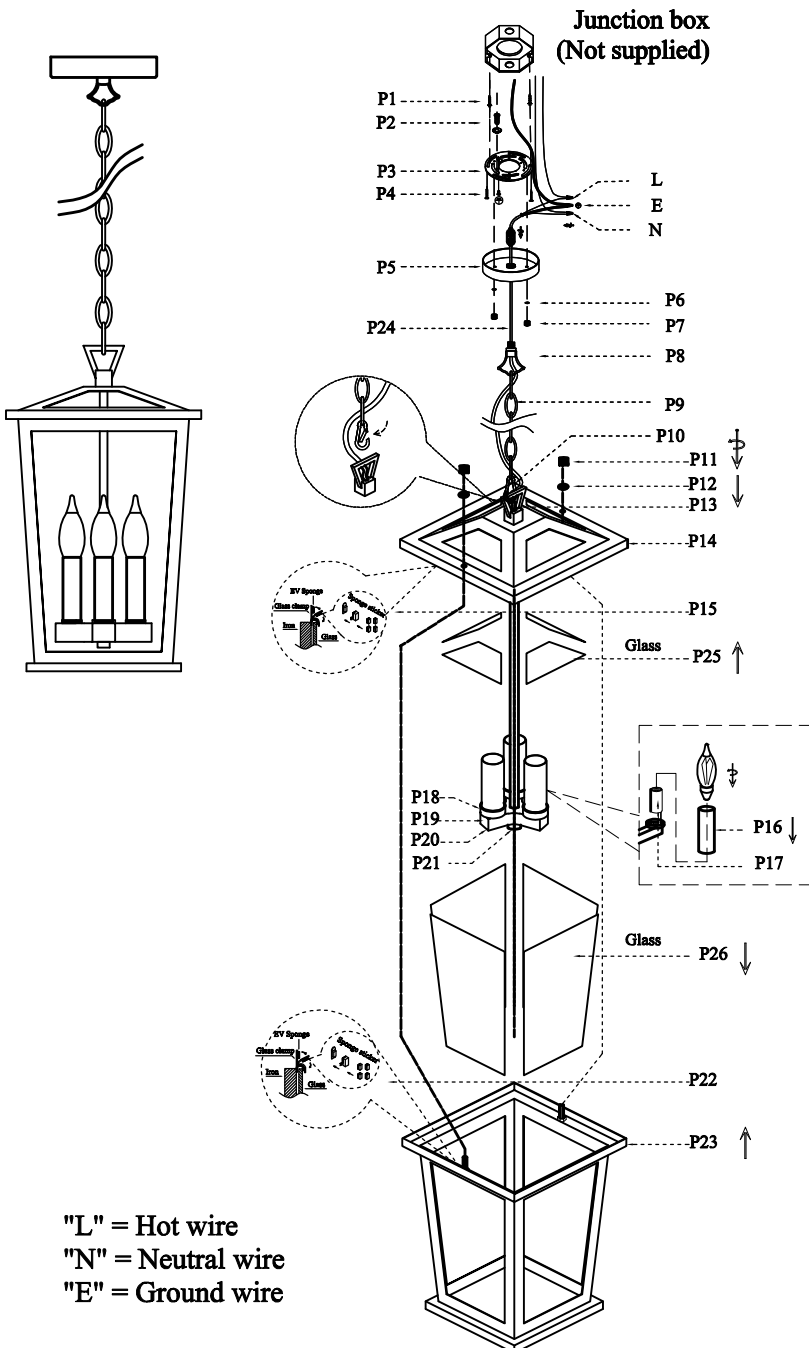

















Installation manual for:

OD332H16BK L9.5" W9.5" H16" L3

**Installation instructions:**

1. Install tube (P16) on lamp holder
2. Install E12\*3 light source. (Bulbs not supplied)
3. Put glass (P25) into Connect cover (P14) and stick sponge on clips (P15). Finally curve clips to fix glass
4. Put glass (P26) into body (P23) and stick sponge on clips (P22). Finally curve clips to fix glass
5. Connect cover (P14) with body (P23) and use rubber ring (P11) with screw caps to fixable.
6. Use hook (P10) connect (P13). Twist off screw and mat from the hanging ring (P8) and across the middle hole of canopy (P5) and use screw and mat lock in again.
7. Secure mounting bracket to the junction box
8. Black wire from ceiling (junction box) attaches to "L" wire from the fixture
9. White wire from ceiling (junction box) attaches to "N" wire from the fixture
10. "E" wire from the ceiling attaches to "E" wire from the fixture.
11. Screw (P2) through to canopy hole (P5) and then put rubber ring (P6) and twist screw cap (P7) to fix mounting bracket (P3).



Part Number	Part	Picture	Description	Qty
CP12H01BK	P1		Explosion screw	2
	P2		Screws M4	2
	P3		Mounting bracket $\phi 3.94$	1
	P4		Screws M4	2
	P5		Canopy ( $\phi 4.7 \times 0.78$ ")	1
	P6		Rubber ring	2
	P7		Screw cap	2
Chain04PBK	P8		Hanging rings L1.57**W0.59**H1.57"	1
	P9		Chain (L39")	1
	P10		Hook (L1.57**W0.78**H0.15")	1
P-OD332H16BK-1	P11		Screw cap	2
	P12		Rubber ring	2
	P13		50*50*20 Ring	1
	P14		240*240*H40MM Cover	1
	P15		EV Sponge Sponge sticker	12
	P16		$\phi 22 \times H 80$ MM Tube	3
	P17		E12 Holder	3
	P18		$\phi 23 \times 5$ MM Cover	3
	P19		120*74*23MM T-Box	1
	P20		117*71MM T-Plate	1
	P21		$\phi 15 \times 8$ MM Column parts	1
	P22		EV Sponge Sponge sticker	12
	P23		235*235*319MM	1
Cord-59-18#-BK	P24		UL18#L59"Black	1
GP12L14	P25		196*82MM Glass	4
	P26		197*296MM Glass	4