

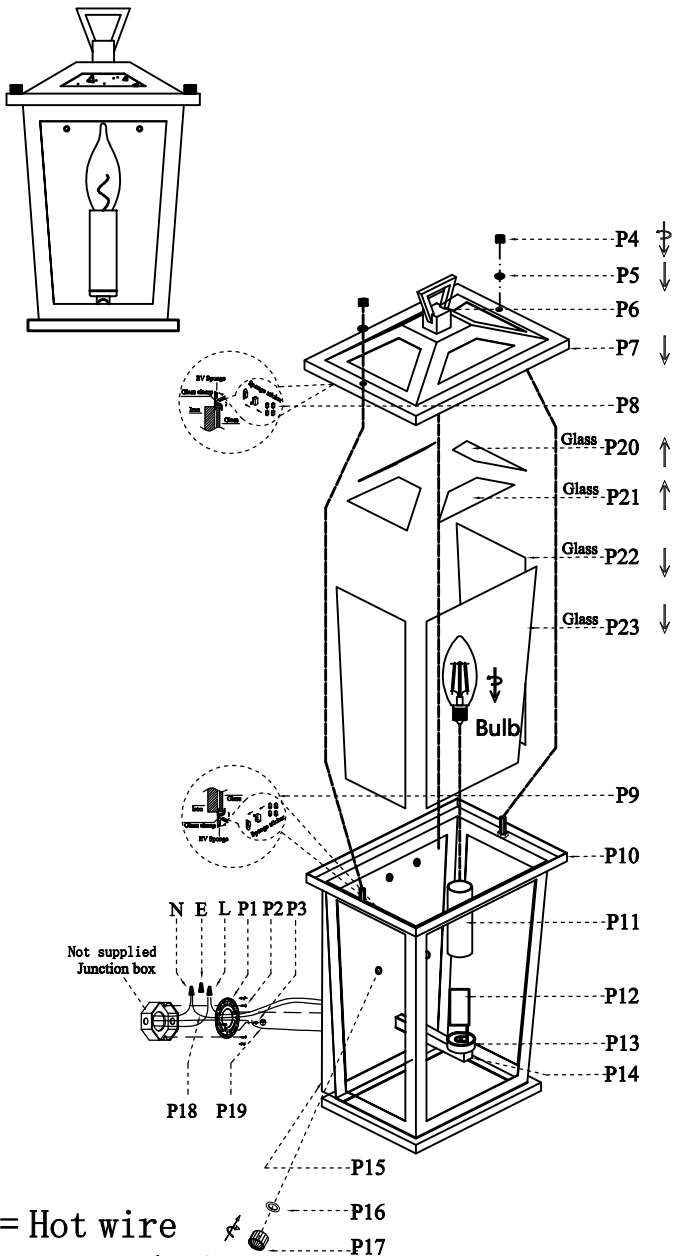























Collection:Richmond
 Installation manual for:

OD331W12BK W7" H12" E6" L1

Installation instructions:

- 1.Install tube(P11)on lamp holder
- 2.Install E12 light source.(Bulbs not supplied) .
- 3.Put glass(P20,P21)into Connect cover(P7) and stick sponge on clips(P8).Finally cruve clips to fix glass.
- 4.Put glass(P22,P23)into into body(P10) and stick sponge on clips(P9).Finally cruve clips to fix glass.
- 5.Connect cover(P7)with body(P10) and use rubber ring(P4) with screw caps to fixable.
- 6.Secure mounting bracket to the junction box
- 7.Black wire from ceiling(junction box) attaches to "L"wire from the fixture
- 8.White wire from ceiling(junction box) attaches to "N"wire from the fixture
- 9."E" wire from the ceiling attaches to "E" wire from the fixture.
- 10.Use rubber ring(P16)and screw(P17) to fix lamp with wall mounted



Part Number	Part	Picture	Description	Qty
MB12W01	P1		Mounting bracket Ø3.94	1
	P2		Mounting bracket screw M4	2
	P3		Screw M4	1
P-OD331W12BK-	P4		Screw cap	2
	P5		Rubber ring	2
	P6		50*50*20 Ring	1
	P7		180*140*H40MM Cover	1
	P8		EV Sponge Sponge sticker	12
	P9		EV Sponge Sponge sticker	9
	P10		175*135*219MM Body	1
	P11		Ø22*H80MM Tube	1
	P12		E12 Holder	1
	P13		Ø23*5MM Cover	1
	P14		12*12*70MM Tube	1
	P15		200*110*H25MM Back plate	1
	P16		Rubber ring	2
	P17		Screw cap	2
	P18		UL18#Ground wire,L9.8"	1
P19		UL18#,L12"Black+White	1	
GP12L10	P20		99*56MM Glass	2
	P21		134*40MM Glass	2
	P22		137*196MM Glass	2
	P23		97*196MM Glass	1