

Collection: Sheridan

Installation manual for:







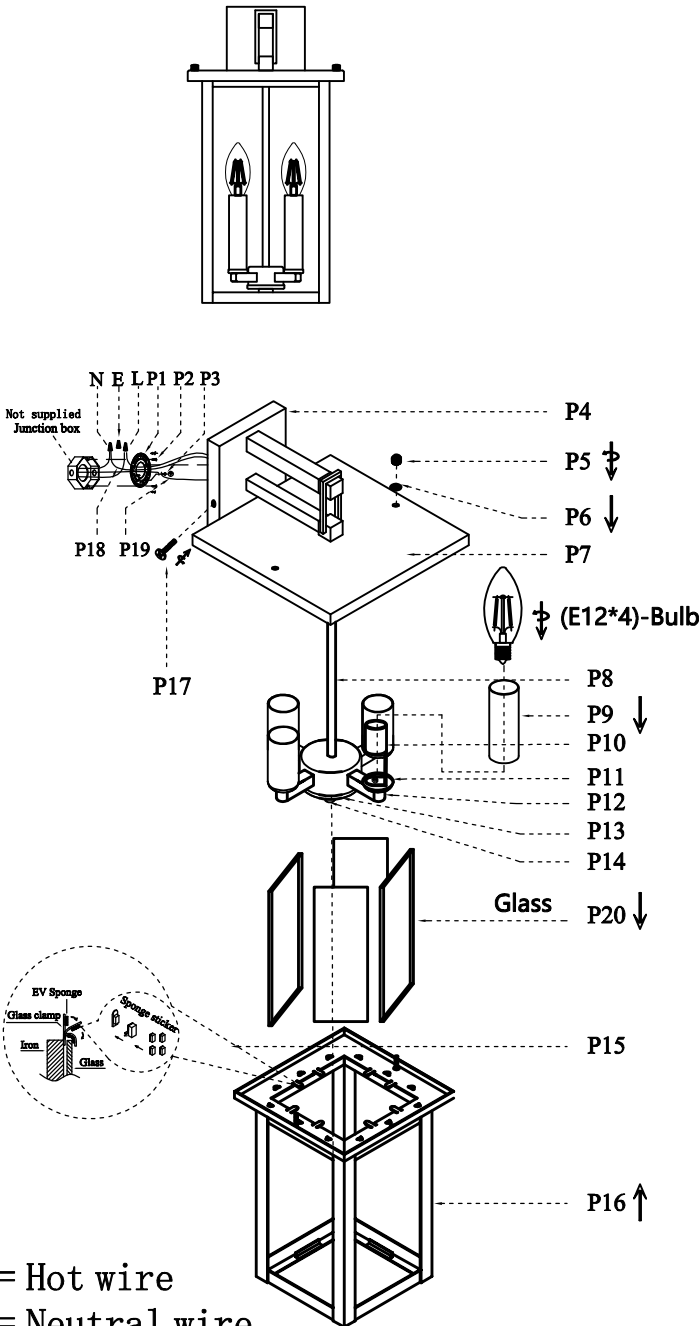









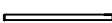



OD324W17BK W9" H17" E10" L4

Installation instructions:

1. Install tube(P9) on lamp holder
2. Install E12*4 light source. (Bulbs not supplied) .
3. Put glass(P20) into body(P16) and stick sponge on clips(P15). Finally curve clips to fix glass.
4. Connect cover(P7) with body(P16) and put rubber ring(P6) and screw caps(P5) to fixable.
5. Secure mounting bracket(P1) to the junction box
6. Black wire from ceiling(junction box) attaches to "L" wire from the fixture
7. White wire from ceiling(junction box) attaches to "N" wire from the fixture
8. "E" wire from the ceiling attaches to "E" wire from the fixture.
9. Use screw(P17) to fix lamp with wall mounted



"L" = Hot wire
"N" = Neutral wire
"E" = Ground wire

Part Number	Part	Picture	Description	Qty
MB12W01	P1		Mounting bracket Ø3.94	1
	P2		Mounting bracket screw M4	2
	P3		Screw M4	1
P-OD324W17BK-1	P4		L140*W110*H180MM Arm	1
	P5		Screw cap	2
	P6		Rubber ring	2
	P7		220*220*15MM Cover	1
	P8		Ø9.3*275MM Tube	1
	P9		Ø22*H100MM Tube	4
	P10		E12 Holder	4
	P11		Ø23*5MM Cover	4
	P12		130*130*H30MM Box	1
	P13		Ø62*5MM Cover	1
	P14		Ø15*8MM Column parte	1
	P15		EV Sponge Sponge sticker	12
	P16		214*214*328MM Body	1
	P17		Screw M4	2
	P18		UL18#Ground wire,L9.8"	1
	P19		UL18#,L12" Black+White	1
	GP12L6	P20		L317*W167MM Glass