

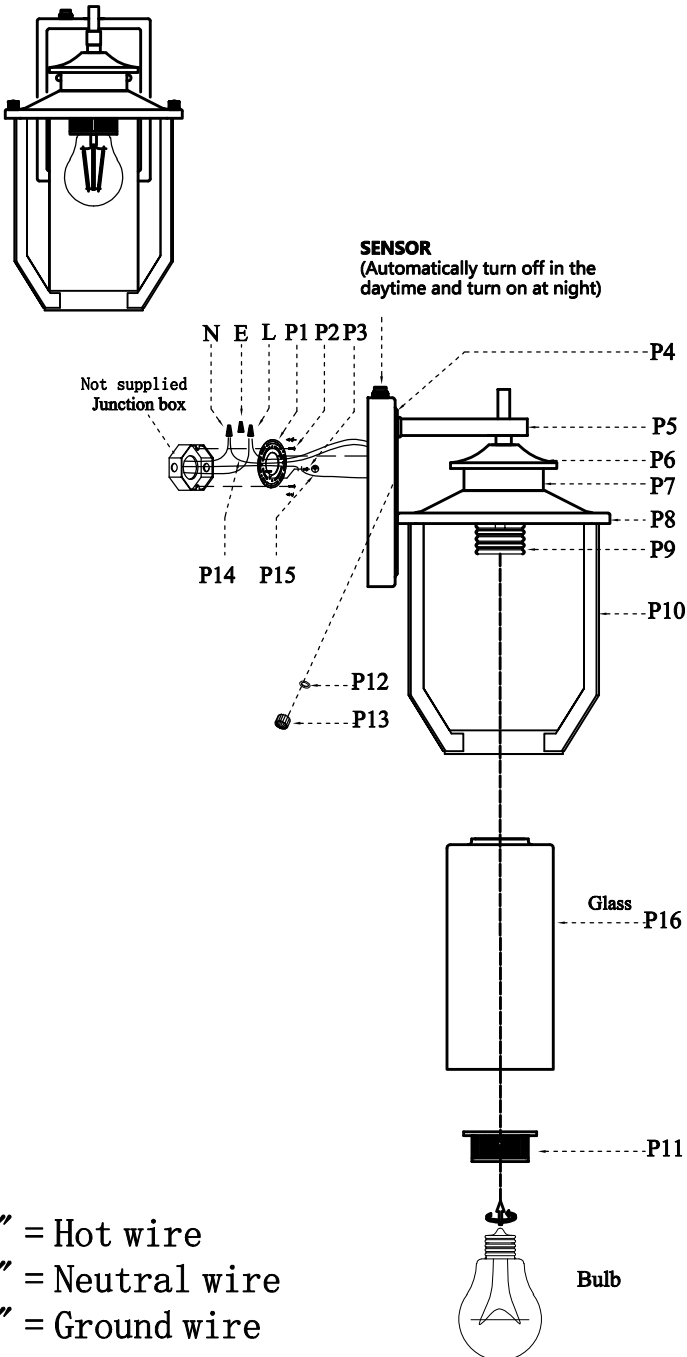













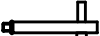

Collection: Sepviva
Installation manual for:

OD323W13BK W7" H12.5" E8" L1

Installation instructions:

1. Put glass(P16) into body(P10)
2. Use socket ring(P11) to lock in glass
3. Install E26 light source.(Bulbs not supplied) .
4. Secure mounting bracket to the junction box
5. Black wire from ceiling(junction box) attaches to "L" wire from the fixture
6. White wire from ceiling(junction box) attaches to "N" wire from the fixture
7. "E" wire from the ceiling attaches to "E" wire from the fixture.
8. Use rubber ring(P12) and screw(P13) to fix lamp with wall mounted



Part Number	Part	Picture	Description	Qty
MB12W01	P1		Mounting bracket Ø3.94	1
	P2		Mounting bracket screw M4	2
	P3		Screw M4	1
P-OD323W13BK-1	P4		160*115*25MM Box	1
	P5		120*47*14MM Arm	1
	P6		90*90*20MM Cover	1
	P7		70*70*26MM Box	1
	P8		180*180*28MM	1
	P9		E26 Holder	1
	P10		173*173*202MM Body	1
	P11		Socket ring	1
	P12		Rubber ring	2
	P13		Screw cap	2
	P14		UL18#Ground wire, L9.8"	1
P15		UL18#, L12" Black+White	1	
GS12R4	P16		Ø90*195MM Glass	1