

Collection: Cambria

Installation manual for:







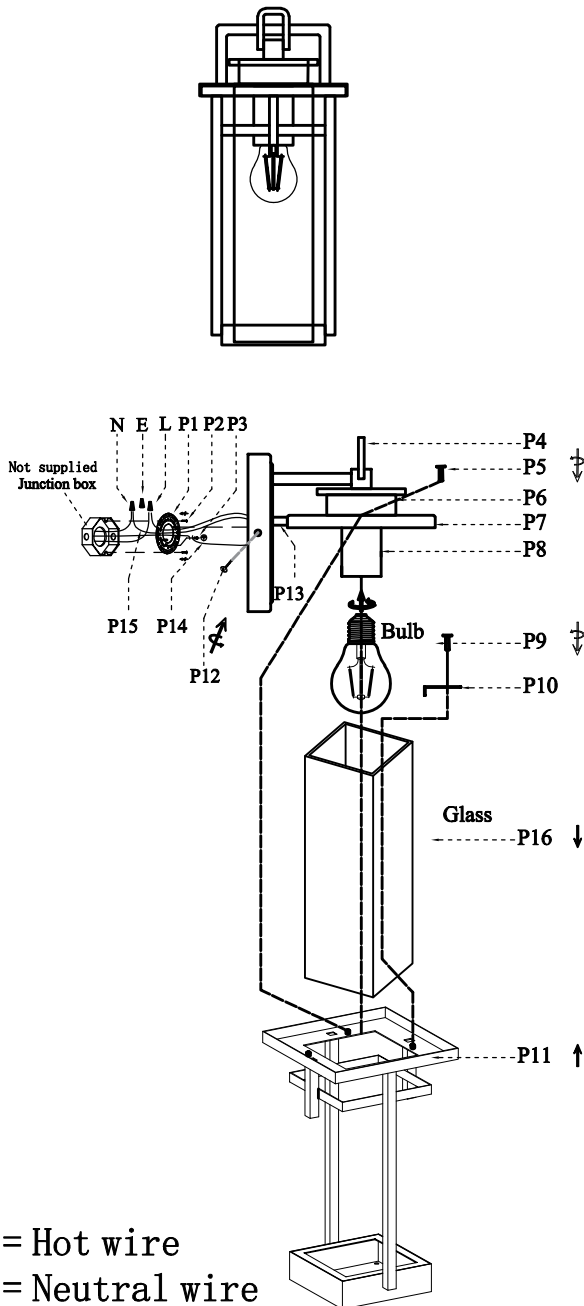









OD320W14BK W6" H14" E7.5" L1

**Installation instructions:**

1. Install E26 light source. (Bulbs not supplied)
2. Install glass (P16) into lamp body (P11) and use clips (P10) with screw (P9) to fix glass.
3. Connect cover (P7) with body (P11) and put screw (P5) to fixable.
4. Secure mounting bracket (P1) to the junction box
5. Black wire from ceiling (junction box) attaches to "L" wire from the fixture
6. White wire from ceiling (junction box) attaches to "N" wire from the fixture
7. "E" wire from the ceiling attaches to "E" wire from the fixture.
8. Use screw (P12) to fix lamp with wall mounted



"L" = Hot wire  
 "N" = Neutral wire  
 "E" = Ground wire

Part Number	Part	Picture	Description	Qty
MB12W01	P1		Mounting bracket Ø3.94	1
	P2		Mounting bracket screw M4	2
	P3		Screw M4	1
P-OD320W14BK-1	P4		177*115*125MM Arm	1
	P5		Screw M4	2
	P6		90*90*26MM Cap	1
	P7		150*150*12MM Cover	1
	P8		E26 Holder	1
	P9		Screw M4	2
	P10		Clips	2
	P11		145*145*265MM Body	1
	P12		Screw M4	2
	P13		Ø8*15MM Tube	1
	P14		UL18#Ground wire, L9.8"	1
	P15		UL18#, L12" Black+White	1
GS12L11	P16		80*80*260MM Glass	1