

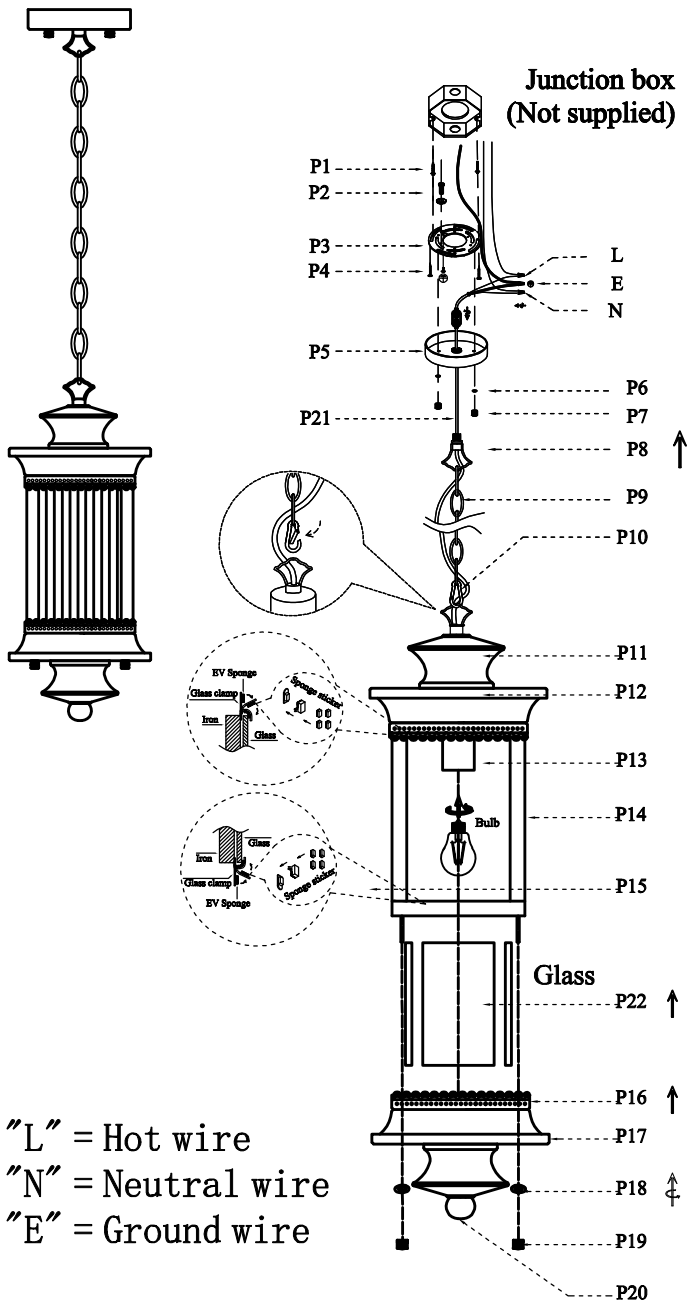





















Collection:Collins  
Installation manual for:

OD316H18BK W7" L7" H17.5" L1

**Installation instructions:**

- 1.Install E26 light source.(Bulbs not supplied)
- 2.Put glass(P22)into body(P14) and stick sponge on clips(P15).Finally curve clips to fix glass.
- 3.Connect cover(P16)with body(P14)and use rubber ring(P18) with screw caps(P19) to fixable.
- 4.Use hook(P10)connect(P11).Twist off screw and mat from the hanging ring(P8) and across the middle hole of canopy(P5 ) and use screw and mat lock in again.
- 5.Black wire from ceiling(junction box) attaches to "L"wire from the fixture
- 6.White wire from ceiling(junction box) attaches to "N"wire from the fixture
- 7."E" wire from the ceiling attaches to "E" wire from the fixture.
- 8.Screw (P2) through to canopy hole(P5) and then put rubber ring(P6) and twist screw cap(P7) to fix mounting bracket(P3).



Part Number	Part	Picture	Description	Qty
CP12H01BK	P1		Explosion screw	2
	P2		Screws M4	2
	P3		Mounting bracket Ø3.94	1
	P4		Screws M4	2
	P5		Canopy(Ø4.7"*0.78")	1
	P6		Rubber ring	2
	P7		Screw cap	2
Chain04PBK	P8		Hanging rings L1.57"*W0.59"*H1.57"	1
	P9		Chain (L39")	1
	P10		Hook (L1.57"*W0.78"*H0.15")	1
P-OD316H18BK-1	P11		Ø98*54MM Cap-A	2
	P12		185*185*10MM Box-A	1
	P13		E26 Holder	1
	P14		180*180*235MM Body	1
	P15		EV Sponge Sponge sticker	16
	P16		180*180*53MM Cover	1
	P17		185*185*10MM Box-B	1
	P18		Rubber ring	2
	P19		Screw cap	2
	P20		Ø20MM Dome	1
Cord-59-18#-BK	P21		UL18#,L59"Black	1
GP12L2	P22		125*195MM Glass	4