

Collection: Janney  
Installation manual for:

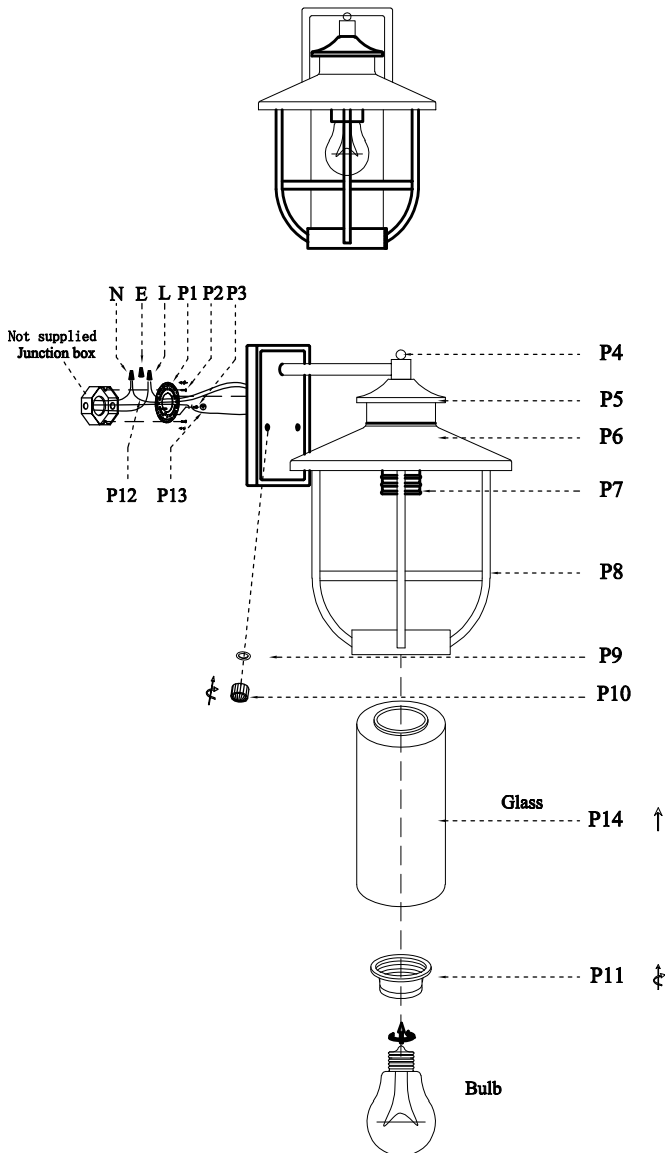













OD314W13BK W9" H12.5" E10" L1

**Installation instructions:**

1. Put glass(P14) into body(P8)
2. Use socket ring( P11) to lock in glass (P14)
3. Install E26 light source.(Bulbs not supplied) .
4. Secure mounting bracket to the junction box
5. Black wire from ceiling(junction box) attaches to "L" wire from the fixture
6. White wire from ceiling(junction box) attaches to "N" wire from the fixture
7. "E" wire from the ceiling attaches to "E" wire from the fixture.
9. Secure mounting bracket to the junction box.
10. Use rubber ring(P9)and screw(P10) to fix lamp with wall mounted



"L" = Hot wire  
"N" = Neutral wire  
"E" = Ground wire

| Part Number    | Part   | Picture   | Description   | Qty             |
|----------------|--------|---|---|-----------------|
| MB12W01        | P1     |                  | Mounting bracket Ø3.94  | 1               |
|                | P2     |                  | Mounting bracket screw M4   | 2               |
|                | P3     |                  | Screw M4  | 1               |
| P-OD314W13BK-1 | P4     |                  | 160*147.5*115MM Arm   | 1               |
|                | P5     |                  | Ø92*25MM Cover  | 1               |
|                | P6     |                  | Ø225*75MM Cover   | 1               |
|                | P7     |                  | E26 Holder  | 1               |
|                | P8     |                  | Ø215*239MM Body   | 1               |
|                | P9     |                  | Rubber ring   | 2               |
|                | P10    |                  | Screw cap   | 2               |
|                | P11    |                  | Socket ring   | 1               |
|                | P12    |                  | UL18#Ground wire,L9.8"  | 1               |
|                | P13    |  | UL18#,L12"Black+White"  | 1               |
|                | GS12R3 | P14   |  | Ø92*193MM Glass |