

Collection: Mercer

Installation manual for:







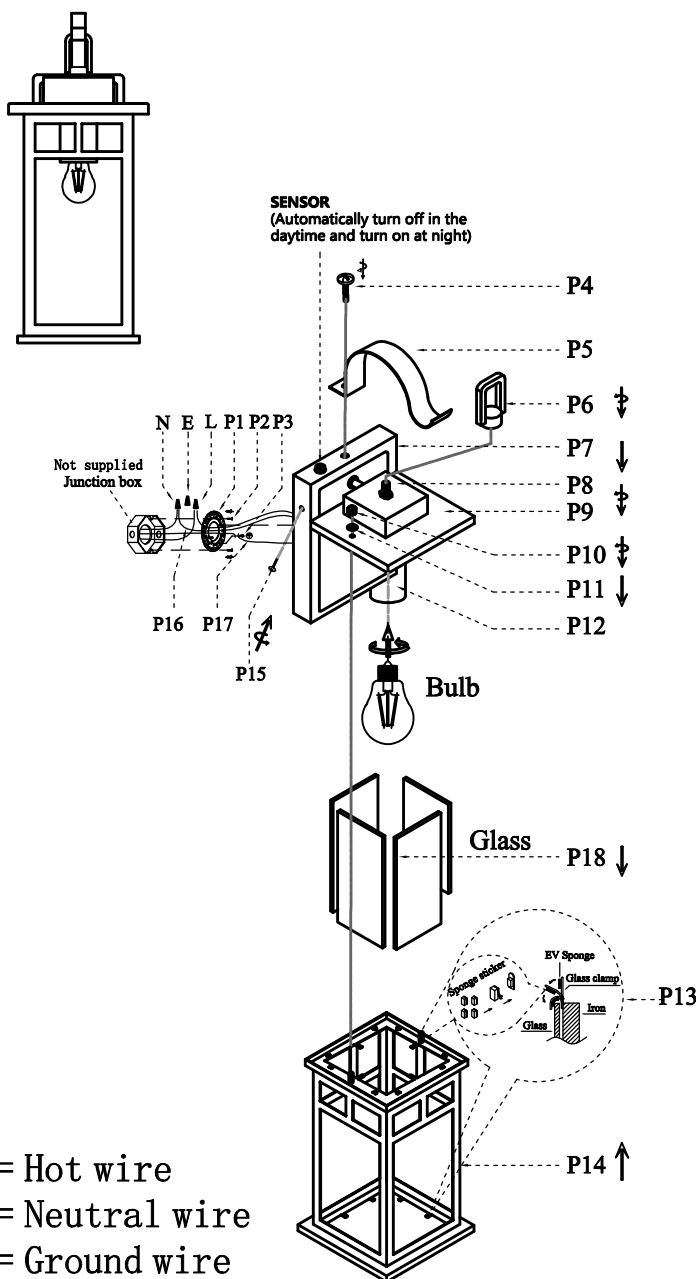











OD313W16BK W6.5" H15.5" E7.5" L1

Installation instructions:

1. Install E26 light source. (Bulbs not supplied)
2. Put glass sheet (P18) into body (P14) and stick sponge mat on glass clips (P13). Finally curve clips to fixable glass.
3. Connect cover (P9) with body (P14) and use rubber ring (P11) with screw caps (P10) to fix.
4. Hanging ring (P6) screw into arm (P8) and then install loop (P5) with the back plate and use screw (P4) lock in
5. Secure mounting bracket to the junction box
6. Black wire from ceiling (junction box) attaches to "L" wire from the fixture
7. White wire from ceiling (junction box) attaches to "N" wire from the fixture
8. "E" wire from the ceiling attaches to "E" wire from the fixture.
9. Fixable lamp to the mounting bracket by screws (P15)



"L" = Hot wire
"N" = Neutral wire
"E" = Ground wire

Part Number	Part	Picture	Description	Qty
MB12W01	P1		Mounting bracket Ø3.94	1
	P2		Mounting bracket screw M4	2
	P3		Screw M4	1
P-OD313W16BK-1	P4		Screw M4	1
	P5		L120*W15*H70MM Loop	1
	P6		50*32*20MM Ring	1
	P7		160*115*25MM Back plate	1
	P8		120*80*30MM Arm	1
	P9		160*160*12MM Cover	1
	P10		Screw cap	2
	P11		Rubber ring	2
	P12		E26 Holder	1
	P13		EV Sponge Sponge sticker	12
	P14		155*155*273MM Body	1
	P15		Screw M4	2
	P16		UL18#Ground wire, L9.8"	1
	P17		UL18#, L12"Black+White	1
	GP12L1	P18		L252*W115MM Glass