

Installation manual for 2550D42BK

Dimensions : L42"W23.3"H23.5"L38

Collection : Vera

Bulb Type : E12 bulb, not include bulbs

Lamp Frame Weight: 52 LBS

Total Weight : 65 LBS



Thank you for choosing our product(s).

Our Company is actively involved in every step of the production.

Our product(s) are designed to be utilized for every application that graces your home or business.

We pride ourselves in providing the most prompt and courtesy service to all of the valued customers.

Please find the enclosed detailed instruction and read carefully for proper installation.

If you have any questions, please contact the retailer Where the purchased was made.

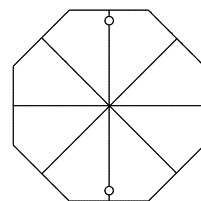

SAFETY

Warning: MAKE SURE THE ELECTRICITY TO THE WIRES YOU ARE WORKING ON IS SHUT OFF. BY EITHER REMOVING THE FUSE OR TURNING OFF THE CIRCUIT BREAKER.

CAUTION

- Before assembling the lighting fixture, please read all instructions carefully.
- All frame & crystal components are fragile, please handle with care.
- Required supply circuit : 110 - 130V/60Hz
- Labeled wires are "L" for live wire, "N" for neutral wire, "E" for ground wire.
- Never install fixture on damp ceiling, the room should be dry and well ventilated
- All electrical components must be installed by a licensed electrician and in accordance with the National Electrical Code and the appropriate local electrical codes.

Unpack the Package

Please open the box carefully and check all the items are inside the box. If you have any installation, assembling and missing parts questions.

where you purchase from and any other relevant information ready, our customer service team will provide comprehensive and worry free service to our valued customers.

Frame Assembly Diagram

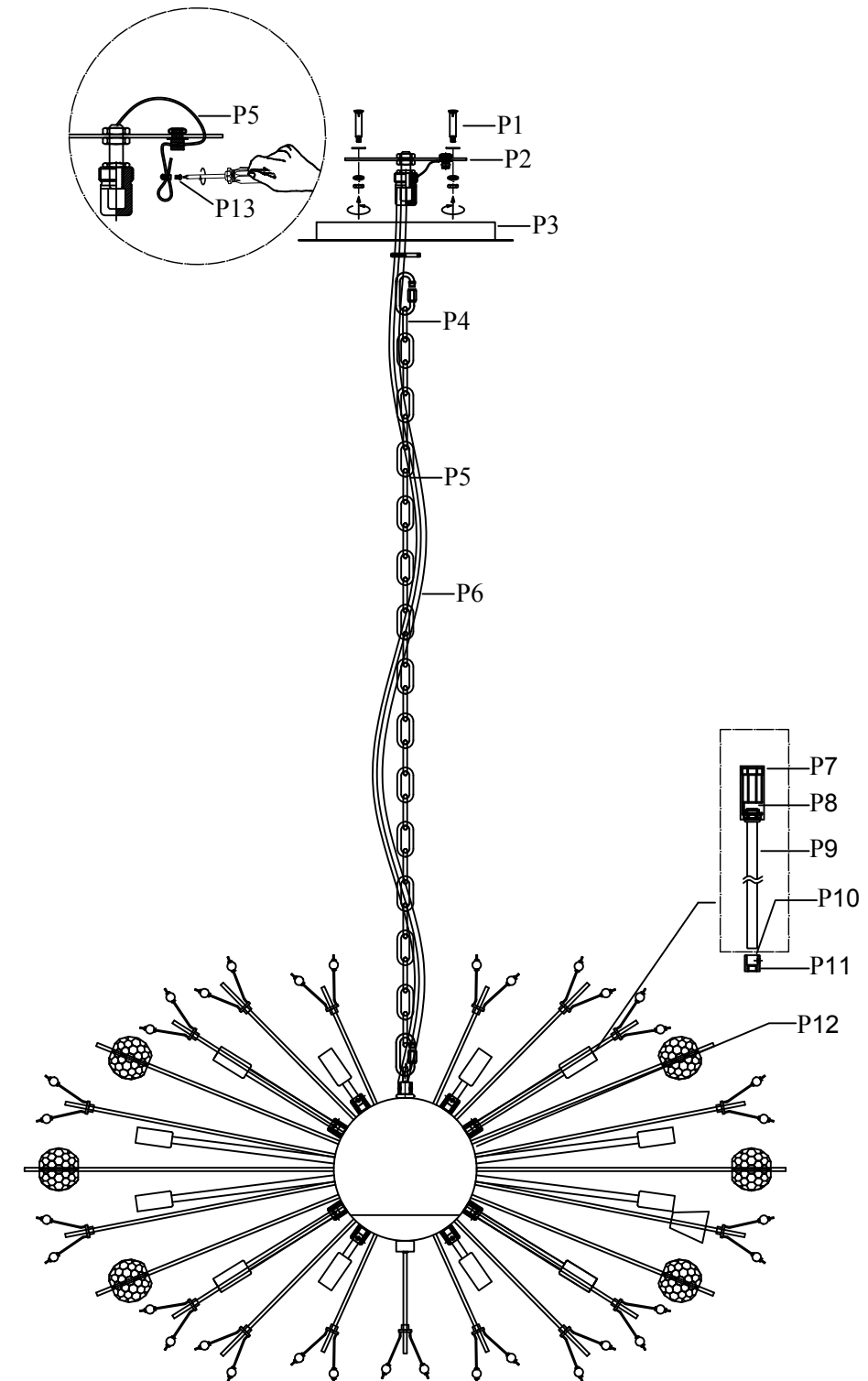









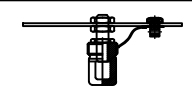
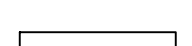

2550D42BK L42"W23.3"H23.5"L38

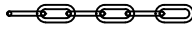
Step 1



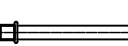

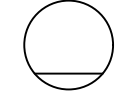
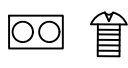
Please use the parts list to ensure you are not missing any parts.

2550D42BK

PARTS LIST

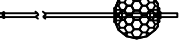
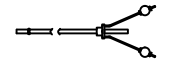
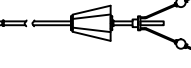
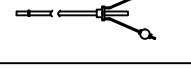
| Parts Number | Part | Picture | Description | Qty |
|---------------------|------|---|----------------------------|-----|
| CP7R61BK | P1 |  | Mounting bracket screw | 4 |
| | P2 |  | Mounting bracket | 1 |
| | P3 |  | Canopy(Ø11.8) | 1 |
| CHAIN06PBK | P4 |  | Activity buckle | 2 |
| | P5 |  | Hanging chain (CHAIN06P) | 1 |
| | P6 |  | Steel wire | 1 |
| 42"Cord-144 | P7 |  | Cord L144" | 1 |
| P-2550D42BK-1 | P8 |  | E12 Socket Cup (Ø0.9"*H2") | 38 |
| | P9 |  | E12 Socket | 38 |
| | P10 |  | Head tube | 38 |
| | P11 |  | metal part | 38 |
| | P12 |  | ball (Φ7.8") | 1 |
| Safety accessory 01 | P13 |  | Safety device+screw | 2 |
| | P14 |  | The Junction Caps | 3 |

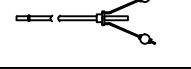
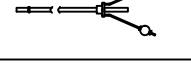
2550D42BK L42"W23.3"H23.5"L38

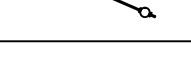
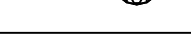
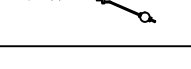
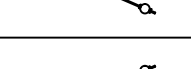
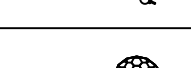
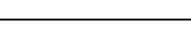
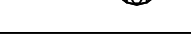
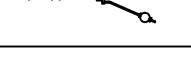
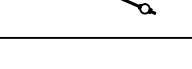
| Parts Number | Part | Picture | Description | Qty |
|----------------|------|---|---|-----|
| P-2550D42BK-A1 | A1 |  | (Metal bars+50# Multi-faceted crystal ball) Length 18.11" | 2 |
| P-2550D42BK-A2 | A2 |  | (Metal bars+Metal Welding flower)Length 16.33" | 4 |
| P-2550D42BK-A3 | A3 |  | (Metal bars+Metal Welding flower +Trapezoidal crystal)Length 14.48" | 4 |
| P-2550D42BK-A4 | A4 |  | (Metal bars+Metal Welding flower)Length 12" | 4 |
| P-2550D42BK-A5 | A5 |  | (Metal bars+50# Multi-faceted crystal ball) Length 10.63" | 4 |
| P-2550D42BK-A6 | A6 |  | (Metal bars+Metal Welding flower)Length 8.45" | 4 |
| P-2550D42BK-A7 | A7 |  | (Metal bars+Metal Welding flower)Length 8.07" | 2 |
| P-2550D42BK-B1 | B1 |  | (Metal bars+Metal Welding flower)Length 16.73" | 4 |
| P-2550D42BK-B2 | B2 |  | (Metal bars+Metal Welding flower)Length 15.55" | 8 |
| P-2550D42BK-B3 | B3 |  | (Metal bars+50# Multi-faceted crystal ball) Length 14.56" | 8 |
| P-2550D42BK-B4 | B4 |  | (Metal bars+Metal Welding flower)Length 11.61" | 8 |
| P-2550D42BK-B5 | B5 |  | (Metal bars+Metal Welding flower)Length 9.64" | 8 |
| P-2550D42BK-B6 | B6 |  | (Metal bars+Metal Welding flower)Length 8.46" | 8 |
| P-2550D42BK-B7 | B7 |  | (Metal bars+50# Multi-faceted crystal ball) Length 8.66" | 4 |
| P-2550D42BK-C1 | C1 |  | (Metal bars+50# Multi-faceted crystal ball) Length 15.35" | 4 |
| P-2550D42BK-C2 | C2 |  | (Metal bars+Metal Welding flower)Length 13.58" | 8 |
| P-2550D42BK-C3 | C3 |  | (Metal bars+Metal Welding flower)Length 11.61" | 8 |

2550D42BK L42"W23.3"H23.5"L38

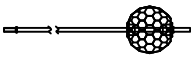
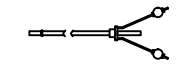
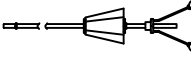
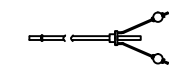
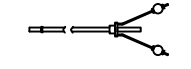
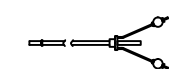
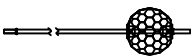
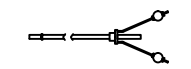
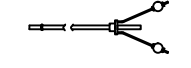
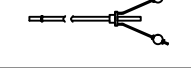
| Parts Number | Part | Picture | Description | Qty |
|----------------|------|---|--|-----|
| P-2550D42BK-C4 | C4 |  | (Metal bars+50# Multi-faceted crystal ball) Length 10.63" | 8 |
| P-2550D42BK-C5 | C5 |  | (Metal bars+Metal Welding flower)Length 8.46" | 8 |
| P-2550D42BK-C6 | C6 |  | (Metal bars+Metal Welding flower +Trapezoidal crystal)Length 8.18" | 4 |
| P-2550D42BK-D1 | D1 |  | (Metal bars+Metal Welding flower)Length 10.82" | 4 |
| P-2550D42BK-D2 | D2 |  | (Metal bars+Metal Welding flower)Length 9.64" | 8 |
| P-2550D42BK-D3 | D3 |  | (Metal bars+Metal Welding flower)Length 8.46" | 8 |
| P-2550D42BK-D4 | D4 |  | (Metal bars+50# Multi-faceted crystal ball) Length 8.66" | 4 |
| P-2550D42BK-E | E |  | (Metal bars+Metal Welding flower)Length 12.79" | 4 |
| P-2550D42BK-F | F |  | (Metal bars+Metal Welding flower)Length 8.85" | 4 |
| P-2550D42BK-G | G |  | (Metal bars+Metal Welding flower)Length 7.28" | 1 |
| | | | | |
| | | | | |
| | | | | |
| | | | | |
| | | | | |
| | | | | |
| | | | | |
| | | | | |
| | | | | |

2550D42BK L42"W23.3"H23.5"L38

| Parts Number | Part | Picture | Description | Qty |
|--------------|------|---------|-------------|-----|
| | | | | |
| | | | | |
| | | | | |
| | | | | |
| | | | | |
| | | | | |
| | | | | |
| | | | | |
| | | | | |
| | | | | |
| | | | | |
| | | | | |
| | | | | |
| | | | | |
| | | | | |
| | | | | |
| | | | | |
| | | | | |
| | | | | |
| | | | | |
| | | | | |
| | | | | |
| | | | | |

Frame Assembly Instructions

Installation:

Please read all instructions carefully. Before you proceed to install make sure that the power supply is turned off and remains off until installation is complete. Please note that each part has been assigned a number. Please proceed in a numerical order.

1. Tighten the lamp holder rod in the corresponding hole of the lamp body.
2. Connect chain (P5) with Lamp body and Mounting bracket (P2).

Step 3

Canopy Installation Instruction

IMPORTANT: Test sockets with bulb before dressing the fixture.

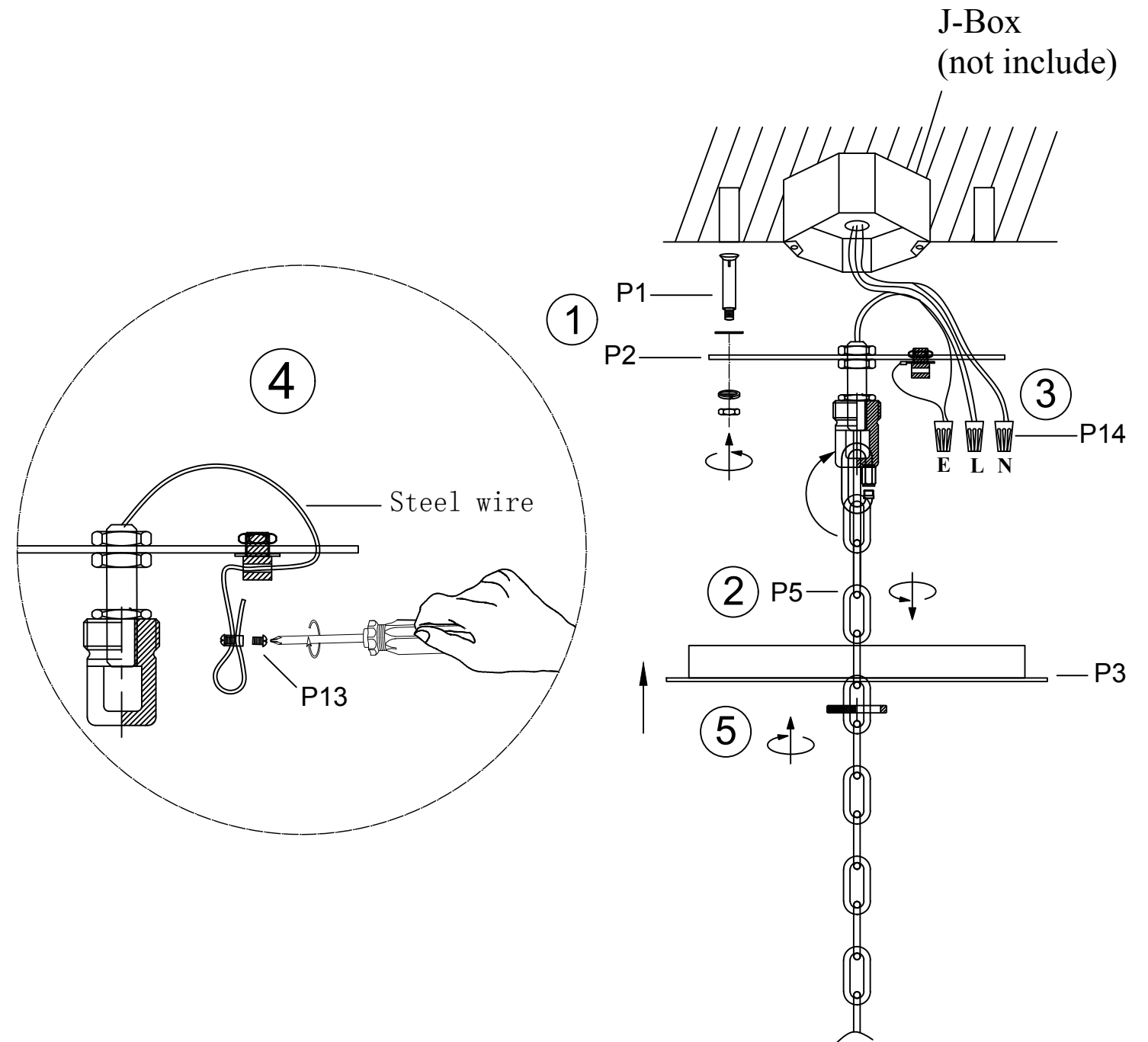

"L"=Hot wire

"N"=Neutral wire

"E"=GND

Canopy Installation Instruction

- ①: Attach the (P2) plate to the ceiling with four (P1) screws.
- ②: Put the chain on the hanging board.
- ③: Thread the power cord under the plate, then wired.
- ④: Lead the steel wire under the hanging plate, through the corresponding holes of the cylindrical iron parts, and fix the (P13) safety device and steel wire with a screwdriver according to the picture.

Thread the steel wire to the Mounting bracket according to the below figure, and then use Safety device to lock the steel wire. Please pull down the excess steel wire to prevent the lamp body from falling. Roll up the excess steel wire put it into the canopy!!!

- ⑤: Fix the lamp body to ceiling(junction box).

Step 4

Crystal Dressing Diagram

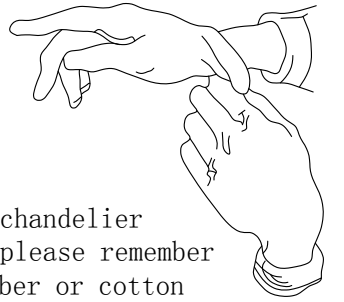

When dressing the chandelier with the crystals please remember to wear either rubber or cotton gloves. So as to prevent any damage or smudging on the crystals.

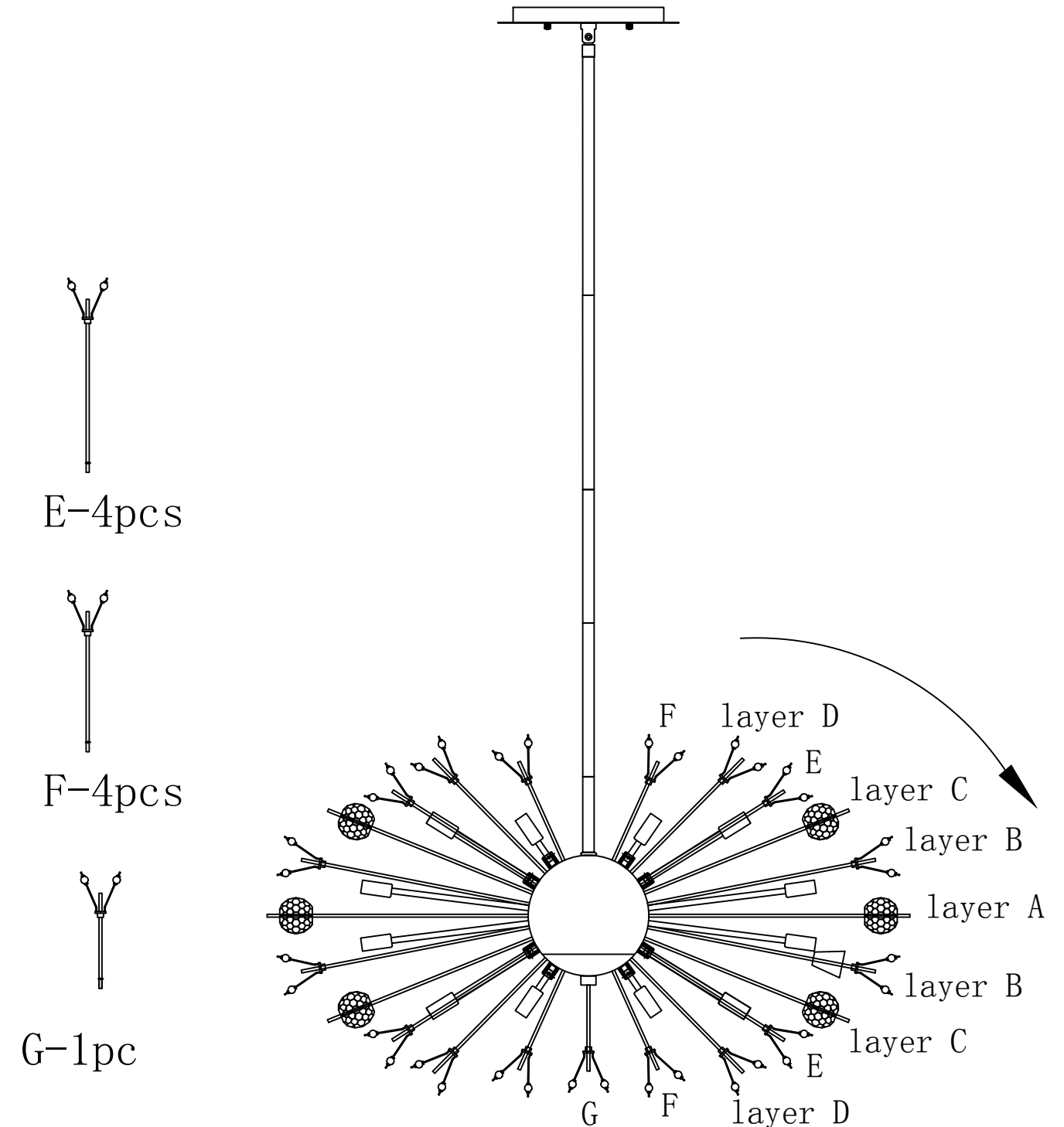

1. First find the holes corresponding to E, F, G, and screw on the crystals corresponding to E, F, G.

2. First find the holes corresponding to D1, and screw on the crystals corresponding to D1, and install the crystals in the order of D1-D4.

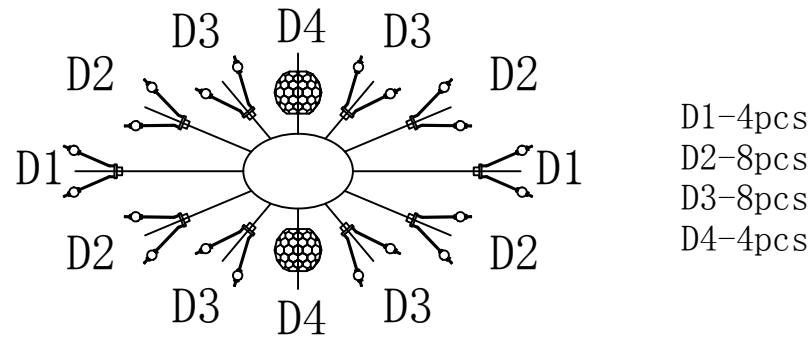
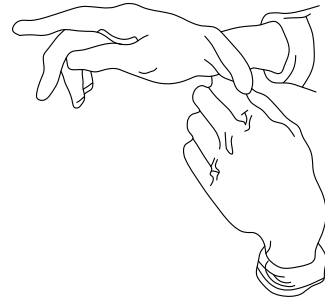

layer D Installation diagram

3. First find the holes corresponding to C1, and screw on the crystals corresponding to C1, and install the crystals in the order of C1-C6.

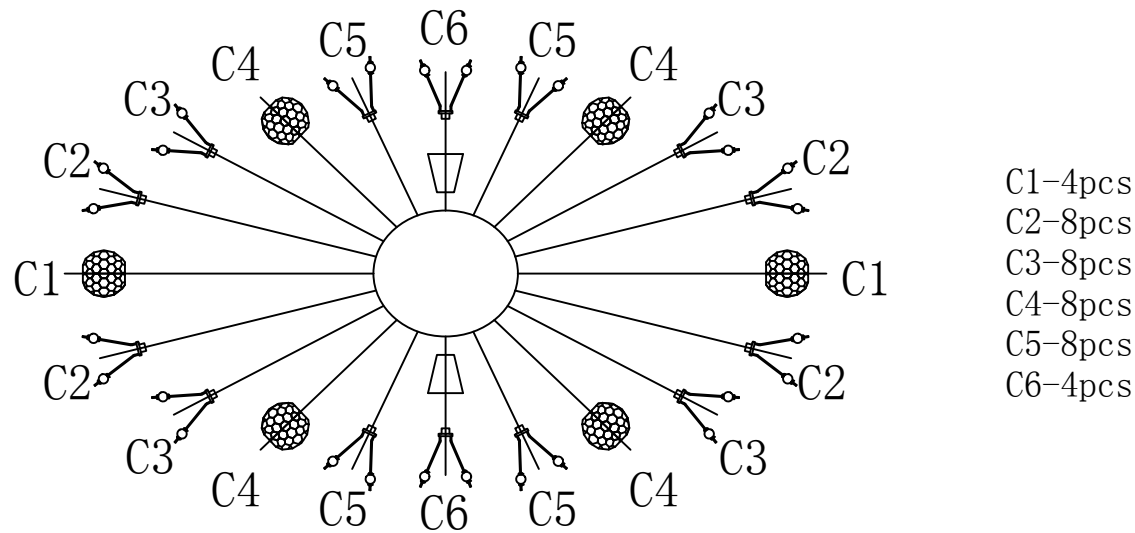

layer C Installation diagram

4. First find the holes corresponding to B1, and screw on the crystals corresponding to B1, and install the crystals in the order of B1-B7.

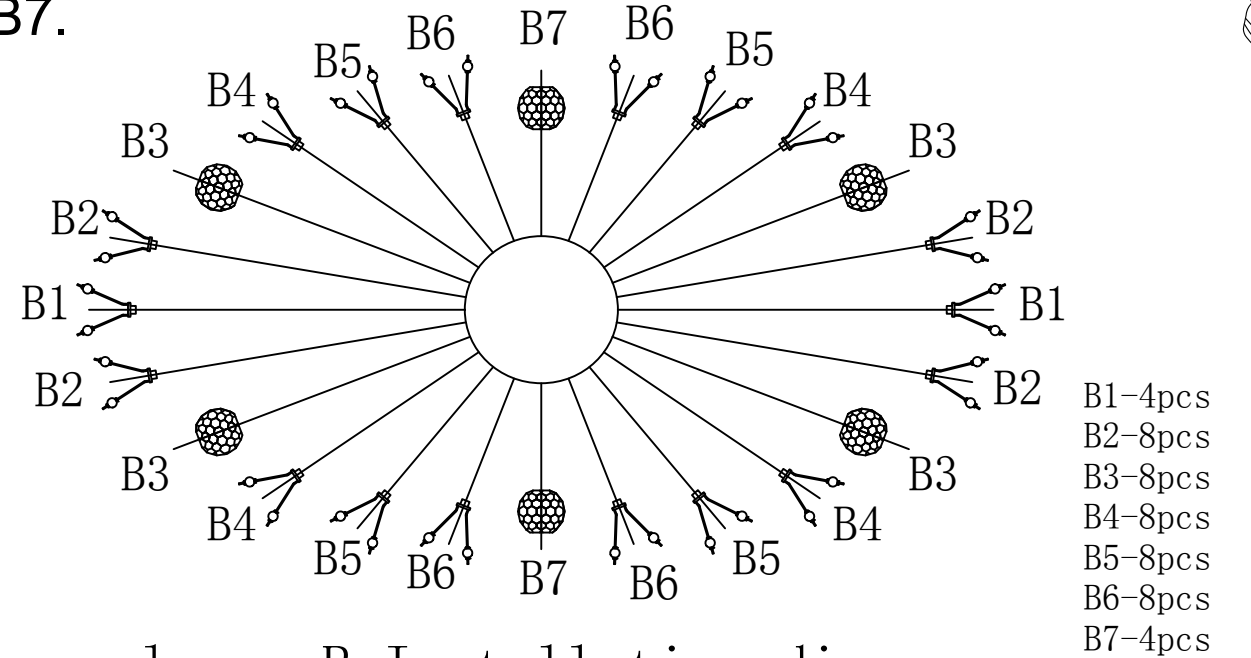

layer B Installation diagram

5. First find the holes corresponding to A1, and screw on the crystals corresponding to A1, and install the crystals in the order of A1-A7.

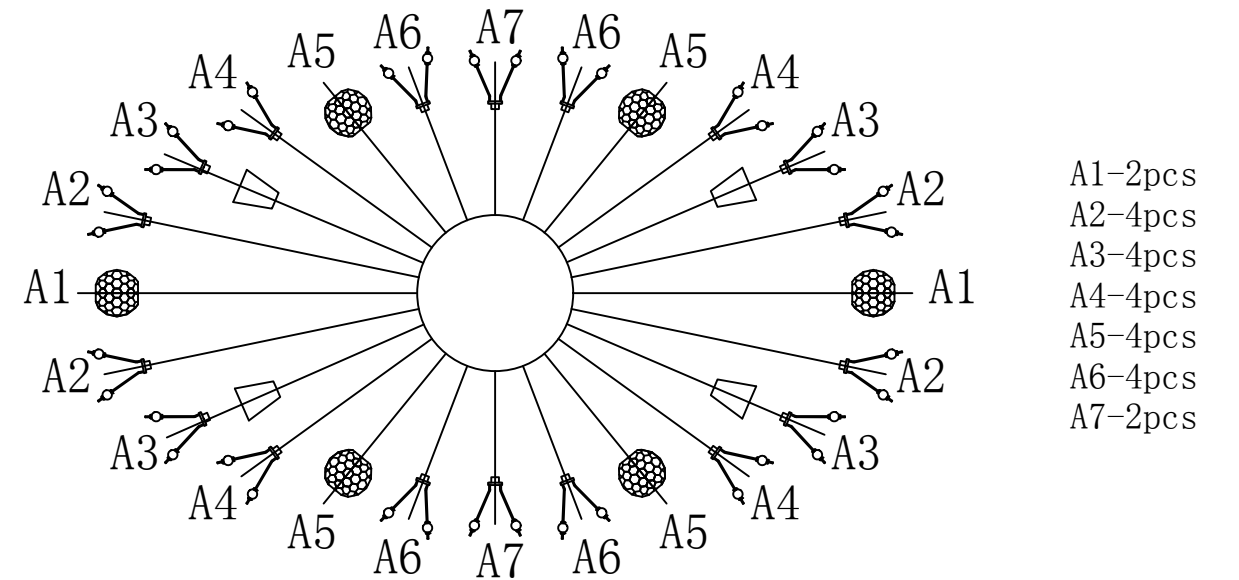

layer A Installation diagram

Congratulations !

You are now done installing your Elegant Lighting fixture. Sit back and admire each crystal as it will become the statement piece for your room/house.

Thank you.

Cleaning and Maintenance of Chandelier Frame
The finish on our chandelier frames and fixture frames is protected by a durable coating of lacquer. To clean, use a clean soft, dry cloth. Do not use any metal polishes, cleaners, abrasives or any substance which could remove the protective finish. Failure to follow these instructions automatically voids the guarantee.

Cleaning and Maintenance of Crystals
Wet a soft cotton fabric in clean warm water and wipe gently, then polish with a dry soft cotton fabric.

To Order Crystal Replacement Parts
Should you require replacement crystals or pins (the metal connectors attaching the crystals), contact the store where the product was purchased or contact us . For ease of ordering, you may use the original crystal trimming instructions provided with this product and circle the items you wish to order, indicating the quantity by writing the number needed adjacent to the circle . You will be contacted with prices prior to shipment. All orders must be pre-paid.

Elegant Lighting Warranty

The finish and frame of your new chandelier or fixture are warranted for a period of one (1) year from the date of purchase. Our company will, at its option, repair or replace any frame that has a defect in the materials or workmanship during the warranty period. All crystals are guaranteed for their original quality during the life of the chandelier. Breakage is not covered by this warranty.

To make a claim under this warranty, contact our customer service department.

A written return authorization form will be sent to you with specific instructions.

Returns and Conditions of Warranty

Returns must be pre-authorized by contacting our customer service department. Returns will only be accepted with a written return merchandise authorization and return shipping charges pre-paid. We reserve the right to inspect all returned merchandise to fully determine the nature of any defect. This guarantee shall not apply to any product that has been changed, altered or otherwise modified, nor shall it apply to any product that has been repaired or altered by anyone other than a pre-authorized facility. We will not be responsible for any breakage or damages incurred during transit, nor for crystal parts or metal frame part that have been subject to misuse, negligence, accident or inappropriate handling. Also, we will not be held responsible for damage incurred during improper installation or wiring by others, nor for damages resulting from a failure to follow the recommended maintenance or installation procedures. This guarantee is issued in lieu of any and all other guaranteed or warranty, whether written or implied and any and all other obligations or liabilities. Further, we neither authorize nor permit any other person or firm to assume for us, any liability in connection with the sale of our products.