



ELEGANT
FURNITURE & LIGHTING™

Installation manual for

1780D42C

Dimensions : D42"*H60" L33

Collection : Emilia

Bulb Type : E12 (bulb not included)

Lamp Frame Weight :47.1 LBS

Total Weight :158 LBS



Thank you for choosing our product(s).

Our Company is actively involved in every step of the production.

Our product(s) are designed to be utilized for every application that graces your home or business.

We pride ourselves in providing the most prompt and courtesy service to all of the valued customers.

Please find the enclosed detailed instruction and read carefully for proper installation.

If you have any questions, please contact the retailer

Where the purchased was made.



1780D42C D42"*H60" L33

SAFETY

Warning: MAKE SURE THE ELECTRICITY TO THE WIRES YOU ARE WORKING ON IS SHUT OFF. BY EITHER REMOVING THE FUSE OR TURNING OFF THE CIRCUIT BREAKER.

CAUTION

- Before assembling the lighting fixture, please read all instructions carefully.
- All frame & crystal components are fragile, please handle with care.
- Required supply circuit : 110 - 130V/60Hz
- Labeled wires are "L" for live wire, "N" for neutral wire, "E" for ground wire.
- Never install fixture on damp ceiling, the room should be dry and well ventilated
- All electrical components must be installed by a licensed electrician and in accordance with the National Electrical Code and the appropriate local electrical codes.

Unpack the Package

Please open the box carefully and check all the items are inside the box. If you have any installation, assembling and missing parts questions. where you purchase from and any other relevant information ready, our customer service team will provide comprehensive and worry free service to our valued customers.

①

1780D42C D42"*H60" L33

Frame Assembly Diagram

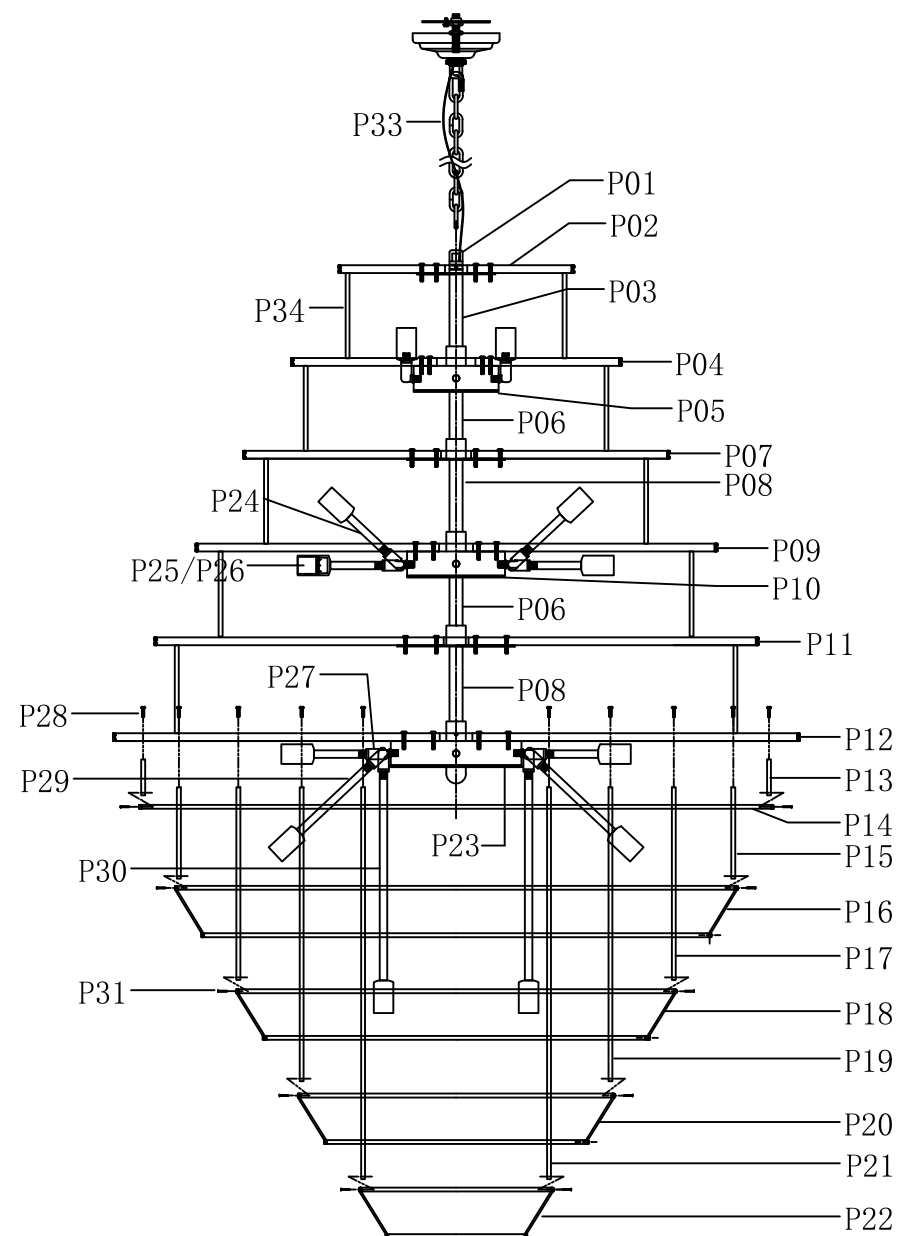

②











1780D42C D42"*H60" L33

Step 1





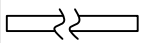

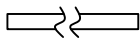

Please use the parts list to ensure you are not missing any parts.

1780D42

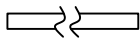

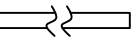
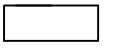
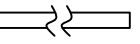
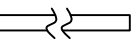

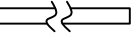







PARTS LIST

Part	Picture	Description	Parts number	Qty	Check list
ZA		Canopy cover D5.3"*H1.2 (Canopy part)	CP10R53L3CH	1	
ZB		Crossbar 4" (Canopy part)		1	
ZC		Canopy ring (Canopy part)		1	
ZD		Canopy loop (Canopy part)		1	
ZE		L59"CHAIN04P Plain Design	CHAIN04PCH	1	
ZF		ground wire		1	
ZG		junction caps		2	
ZH		Power Cord 118"/SPT-2-16# Clear		1	
P01		Quick link	P-1780D42C-1	1	
P02		D14.2"*H0.47" metal frame		1	
P03		D0.8"*H5.7" metal tube		1	







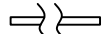
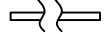

1780D42C D42"*H60" L33

Part	Picture	Description	Parts number	Qty	Check list
P04		D19.9"*H0.47" metal frame	P-1780D42C-1	1	
P05		ø5.1 Metal Wire Box		1	
P06		D0.8"*H2.7" metal tube		2	
P07		D25.7"*H0.47" metal frame		1	
P08		D0.8"*H5.3" metal tube		2	
P09		D31.4"*H0.47" metal frame		1	
P10		ø5.9 Metal Wire Box		1	
P11		D36.4"*H0.47" metal frame		1	
P12		D41.3"*H0.47" metal frame		1	
P13		L2.2" square pipe		3	
P14		D38.2"*H0.3" metal ring		1	
P15		L5.5" square pipe		3	

1780D42C D42"*H60" L33

Part	Picture	Description	Parts number	Qty	Check list
P16		D33.9"*H0.47" metal frame	P-1780D42C-1	1	
P17		L11.6" square pipe		3	
P18		D26.5"*H0.47" metal frame		1	
P19		L17.7" square pipe		3	
P20		D19"*H0.47" metal frame		1	
P21		L23.6" square pipe		3	
P22		D11.6"*H0.47" metal frame		1	
P23		φ7.9 Metal Wire Box		1	
P24		L3.1" Metal tube		20	
P25		E12 Socket		33	
P26		D1.2"*H2" lamp cup		33	
P27		Shake rod		33	

1780D42C D42"*H60" L33

Part	Picture	Description	Parts number	Qty	Check list
P28		M5*L0.8" screw		15	
P29		L5.9" Metal tube		6	
P30		L10.6" Metal tube		3	
P31		M4*L0.6" screw		15	
P32		M4 screw & Screw cap	SCRC-CH	314	
A		Glass	GLASS1780A	314	
B		Crystal	CRY1780A	263	
C		plastic washer (for glass A)	R-R	314	
P33		118" Steel wire		1	
P34		L5" square pipe		15	

1780D42C D42"*H60" L33

IMPORTANT: Test sockets with bulb before dressing the fixture.

- 1 .Attach the crossbar to the electrical box.
- 2 .Pass the lamp wire and ground wire through the loop, canopy ring and center hole of canopy cover.
- 3 .Screw 2.5" threaded pipe into the crossbar and fasten with hex-nut.
- 4 .Pull wires up through the nipple.
- 5 .Screw loop only onto threaded pipe.
- 6 .Hang the fixture on chain.
- 7 .Make the electrical connections as detailed in the drawing above.
- 8 .Secure the canopy cover with threaded canopy ring .

09

1780D42C D42"*H60" L33

Step 3

Frame Assembly Diagram

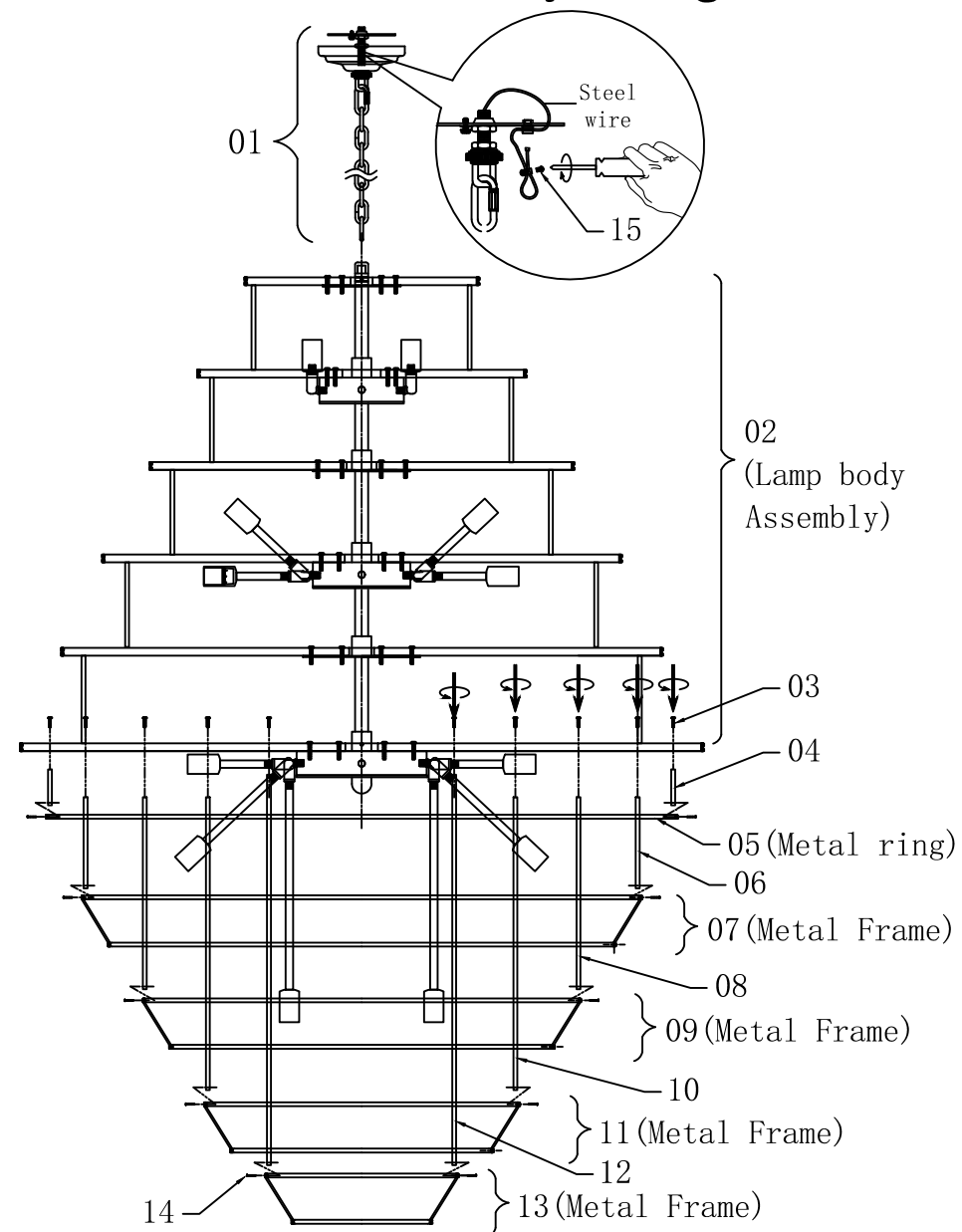

10

Frame Assembly Instructions

Installation:

Please read all instructions carefully. Before you proceed to install, make sure that the power supply is turned off and remains off until installation is complete. Please note that each part has been assigned a number. Please proceed in a numerical order.

1. Connect the canopy parts(01) to the lamp body assembly(02).
2. Connect the square pipe(04) (06) (08) (10) (12)to the metal ring(05), metal frame(07) (09) (11) (13)and the lamp body assembly (02)by screws (03) (14).
2. Hang the canopy parts (01) on the Ceiling Plate.
3. Screw the Bulb on the Lamp Holder. (bulb not included)
4. Lead the steel wire under the hanging plate, through the corresponding holes of the cylindrical iron parts, and fix the (15) safety device and steel wire with a screwdriver according to the picture.

1780D42C D42"*H60" L33 Step 4 Crystal Dressing Diagram



1. Hanging the plastic washer(C)and glass (A) on the lamp by Screw cap, As shown in the figure.
2. Hanging the crystal (B) on the lamp.

When dressing the chandelier with the crystals please remember to wear either rubber or cotton gloves. So as to prevent any damage or smudging on the crystals.

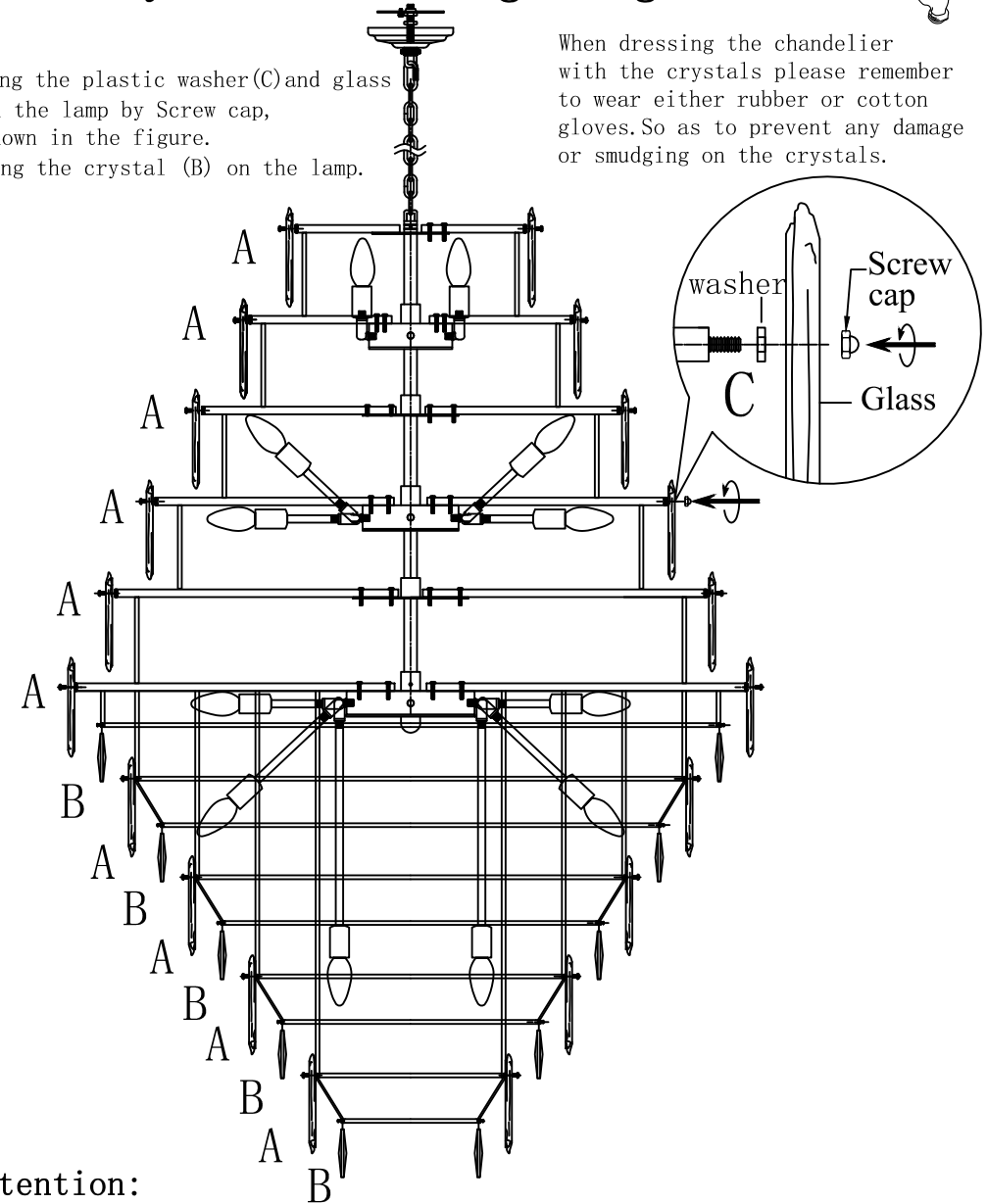

Attention:

Install light bulb first before assembling crystal and glass. Please do not over-tighten! Hand tighten glass screw only! Do not use power tools.

1780D42C D42"*H60" L33

Congratulations !

You are now done installing your Elegant Lighting fixture. Sit back and admire each crystal as it will become the statement piece for your room/house.

Thank you.

1780D42C D42"*H60" L33

Cleaning and Maintenance of Chandelier Frame

The finish on our chandelier frames and fixture frames is protected by a durable coating of lacquer. To clean, use a clean soft, dry cloth. Do not use any metal polishes, cleaners, abrasives or any substance which could remove the protective finish. Failure to follow these instructions automatically voids the guarantee.

Cleaning and Maintenance of Crystals

Wet a soft cotton fabric in clean warm water and wipe gently, then polish with a dry soft cotton fabric.

To Order Crystal Replacement Parts

Should you require replacement crystals or pins (the metal connectors attaching the crystals), contact the store where the product was purchased or contact us . For ease of ordering, you may use the original crystal trimming instructions provided with this product and circle the items you wish to order, indicating the quantity by writing the number needed adjacent to the circle . You will be contacted with prices prior to shipment. All orders must be pre-paid.

1780D42C D42"*H60" L33

Elegant Lighting Warranty

The finish and frame of your new chandelier or fixture are warranted for a period of one (1) year from the date of purchase. Our company will, at its option, repair or replace any frame that has a defect in the materials or workmanship during the warranty period. All crystals are guaranteed for their original quality during the life of the chandelier. Breakage is not covered by this warranty.

To make a claim under this warranty, contact our customer service department.

A written return authorization form will be sent to you with specific instructions.

1780D42C D42"*H60" L33

Returns and Conditions of Warranty

Returns must be pre-authorized by contacting our customer service department. Returns will only be accepted with a written return merchandise authorization and return shipping charges pre-paid. We reserve the right to inspect all returned merchandise to fully determine the nature of any defect. This guarantee shall not apply to any product that has been changed, altered or otherwise modified, nor shall it apply to any product that has been repaired or altered by anyone other than a pre-authorized facility. We will not be responsible for any breakage or damages incurred during transit, nor for crystal parts or metal frame part that have been subject to misuse, negligence, accident or inappropriate handling. Also, we will not be held responsible for damage incurred during improper installation or wiring by others, nor for damages resulting from a failure to follow the recommended maintenance or installation procedures. This guarantee is issued in lieu of any and all other guaranteed or warranty, whether written or implied and any and all other obligations or liabilities. Further, we neither authorize nor permit any other person or firm to assume for us, any liability in connection with the sale of our products.