

# LIVING DISTRICT

Collection: Hanson

Installation manual for:









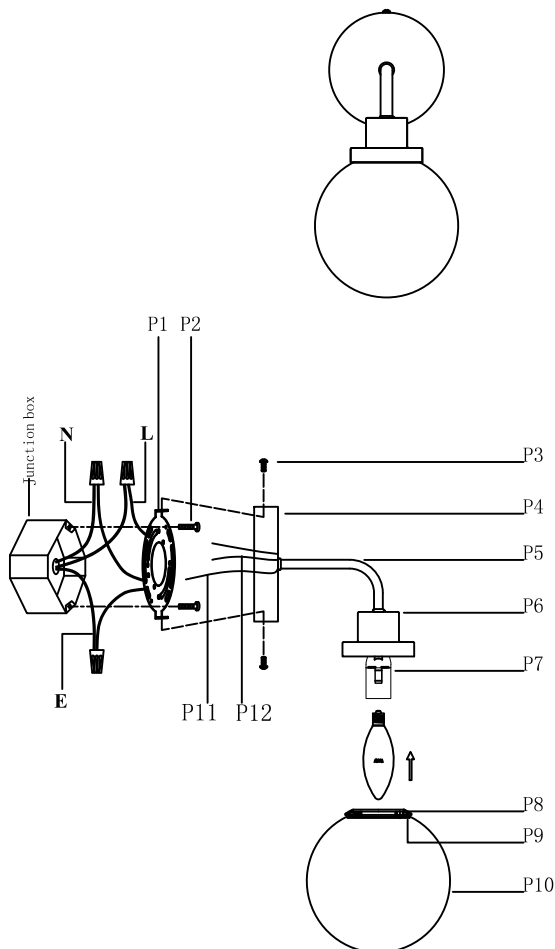

LD7030W8C W5.9" E8.1" H11.7" L1

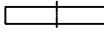
## Installation instructions:

1. Black wire from ceiling(junction box) attaches to "L"wire from the fixture.
  2. White wire from ceiling(junction box) attaches to "N"wire from the fixture.
  3. "E" wire from the fixture is attached to the mounting bracket and an additional "E" wire from the mounting bracket must be secured to the junction box.
  4. Secure mounting bracket to the junction box.
  5. Insert the mounting bracket screw(P2) into the mounting bracket (P1)
  6. Use the screw(P3) to lock the lamp body to the mounting bracket (P1) on the ceiling.
  7. Install E12 light source.(Bulbs not supplied)
  8. Twist the glass ball(P10) onto the lamp body(P6)
- The end!

## PARTS LIST



Part Number	Part	Picture	Description	Qty
MB7R01	P1		mounting bracket Φ4.53"*H0.59"	1
	P2		Mounting bracket screw	2
P-LD7030W8C-1	P3		Screw	2
	P4		Backplate (Φ4.72"*H0.98")	1
	P5		Double head tube (L4.8"*H2.6")	1
	P6		Double layer cup Φ3"*H1.8"	1
	P7		E12 holder	1
	P11		UL18#Ground wire, L9.84"	1
	P12		UL18#, L6"	1
GS7R02	P8		Aluminum ring Φ2.7"*H0.3"	1
	P9		Plate Φ1.8"*T0.1"	1
	P10		Glass shade Φ5.9"*H5.7"	1

"L" = Hot wire

"N" = Neutral wire

"E" = Ground wire