

LIVING DISTRICT

Collection: Octavia

Installation manual for:













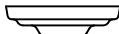

LD4067D8 D7.9"H9"L1

Installation instructions:

1. Metal chain pass through canopy ring (P7) and canopy cover (P6) then hanging the quick link (P8) to canopy lock (P4) and the lamp body.
2. Power cord need to pass through the chain, canopy ring (P7), canopy plat (P6), canopy lock (P4) and clasp (P1).
3. Black wire from ceiling(junction box) attaches to "L" wire from the fixture.
4. White wire from ceiling(junction box) attaches to "N" wire from the fixture.
5. Insert screws (P5) in side of top unit the mounting bracket (P2).
6. "E" wire from the fixture is attached to the mounting bracket and an additional "E" wire from the mounting bracket must be secured to the junction box.
7. Using Canopy ring (P7) lock the Canopy cover(P6).
8. Install the bulb(not included) in lamp holder (P14).

The end!

PARTS LIST

part	picture	Description	Qty	Check list
P1		Clasp	1	
P2		L4.1" Mounting bracket	1	
P3		Threaded pipe	1	
P4		Canopy lock	1	
P5		5/32-32 Screw	2	
P6		Φ5.5" Canopy cover	1	
P7		Canopy ring	1	
P8		Quick link	2	
P9		Power Cord 6.5' SPT-1 18# black	1	
P10		L59"CHAIN04	1	
P11		Loop	1	
P12		Threaded pipe	2	
P13		Φ1.7"*2.5 Lamp cup	1	
P14		E26 Lamp holder	1	
P15		7.9" Lampshade	1	

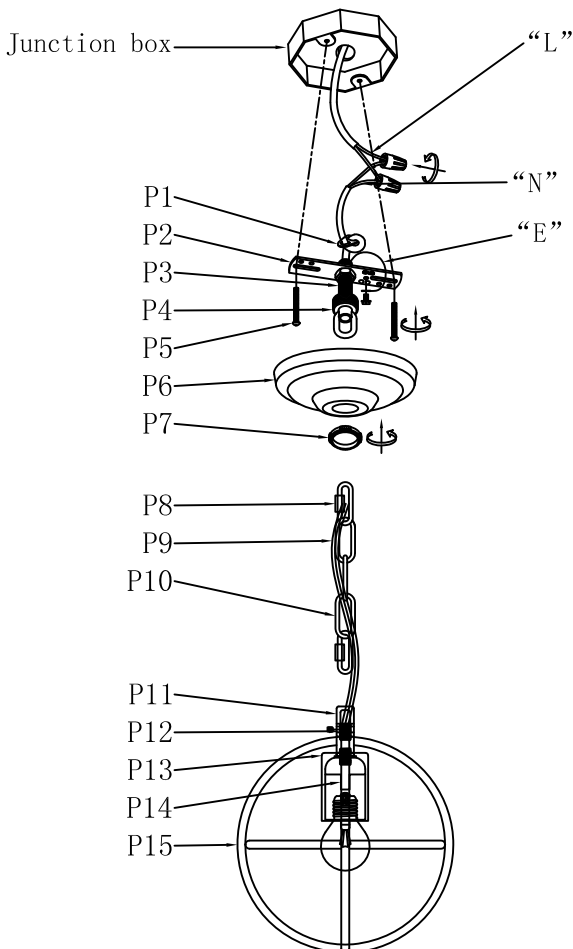

"L" = Hot wire

"N" = Neutral wire

"E" = Ground wire