

2075D18C  
D18"H134" L6

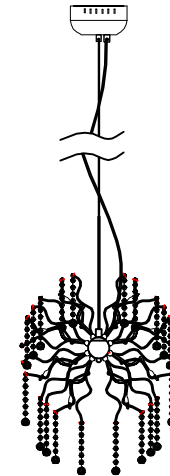

**We are dedicated to providing the finest quality crystal chandelier for our customers. Our master craftsmen and designer pride themselves on their attention to detail. prompt, efficient service is our priority.**

**Enclosed, are detailed instructions on how to properly install your chandelier. Please read all instructions carefully and thoroughly. If you have any questions please feel free to call our toll free CHANDELIER HOTLINE AT:**

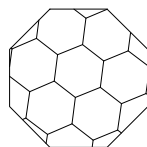

1-888-388-3390



2075D18C D18"H134" L6

## WARNING!!!

### CONTENTS ARE FRAGILE HANDLE WITH CARE

The metal frame and crystal components of this chandelier are very delicate. Please exercise extreme caution during unpacking and installation.

## WARNING!!!

After passing the main electrical wire through the 10mm pipe and connecting the pipe to the main body top connector, place all remaining pieces as shown in numerical order and in the orientation depicted. Refer to the parts list to avoid confusion between parts. The part numbers coincide.

## CAUTION

1. Rated 110-130V/60Hz, bulb 20W maximum
2. Care should be taken to avoid damage to the surface of lighting and wire, wearing gloves is recommended when installing.
3. Connect black or red wire of the lighting to live wire and white or blue wire to neutral wire and double colored (or bare copper) wire to ground wire.
4. Never install lighting on damp ceiling, the room should be dry and well ventilated.
5. Keep lighting away from acid, alkali and other corrosive chemical or gas, clean the lighting with clean soft cloth only.
6. Installation must be carried out by qualified electrician only.
7. Disconnect the power before installing, cleaning and replacing lighting.
8. Never cover the lighting when power is connected.
9. Firmness must be secured when installing ceiling tube, chain, pipe and other connecting parts.
10. Care should be taken to avoid damage when installing glass parts.
11. All electrical components must be installed by a licensed electrician and in accordance with the National Electrical Code and the appropriate local electrical codes. Make sure that the electrical supply to the chandelier is turned off at the main fuse or circuit breaker before doing any installation.

2075D18C D18"H134" L6

# CANOPY PARTS LIST

**ZA:Existing Electrical Box (not supplied)**

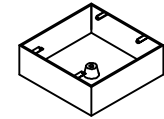

**ZB:Ceiling plate**



**ZC:Box Screws x 4(not supplied)**

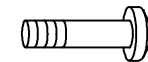

**ZD:Junction Caps**



**ZE:Electric Main**



**ZF:Ground Wire**



**ZG:Ceiling Screws x 3**

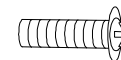

**ZH:Nets canopy**

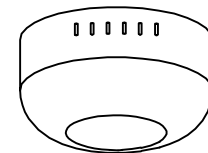

2075D18C D18"H134" L6

## CANOPY INSTALLATION DIAGRAM

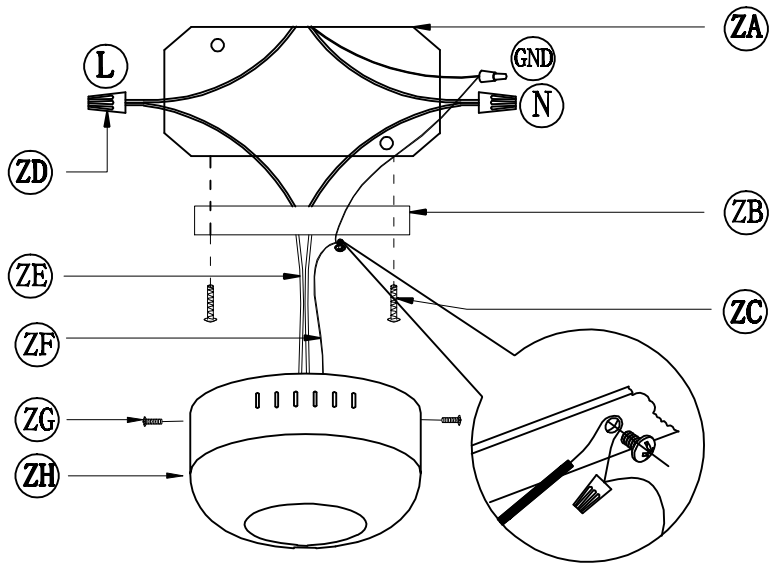

03

2075D18C D18"H134" L6

## Frame Assembly Instructions

Please read all instructions carefully. Before you proceed to install, make sure that the power supply is turned off and remains off until installation is complete. Please note that each part has been assigned a number. Please proceed in numerical order.

1. Attach (Straight pipe)02 to (Cylindrical copper)03.
2. Install (Net Canopy)01 to the electric Box and wire properly.
3. Use the sleeve that come with the (G4 bulb)04 or use cotton cloth when handle the (G4 bulb)04. Please do not touch (G4 bulb)04 with bare hands.
4. Apply (straight iron wire)06 to (ball)05

The end!

08

2075D18C D18"H134" L6

# Frame Assembly Diagram

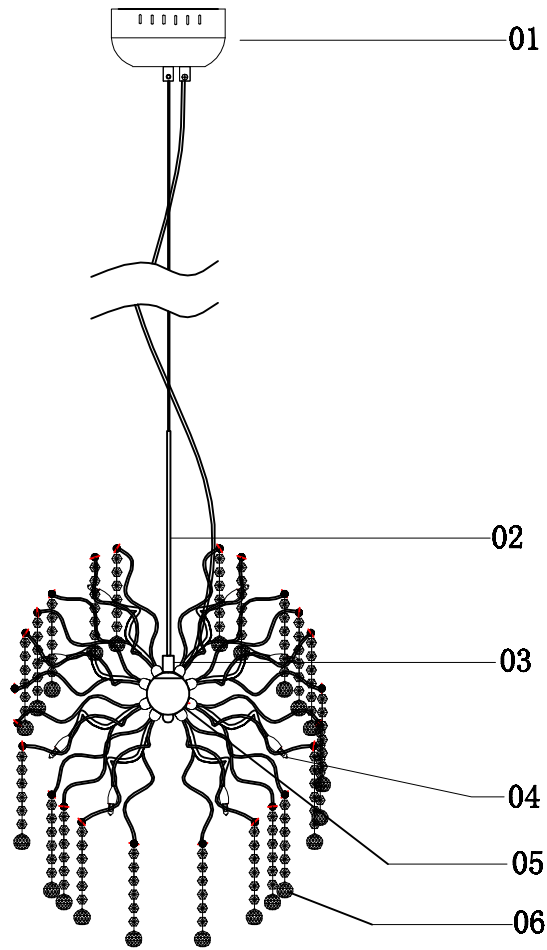

05

2075D18C D18"H134" L6

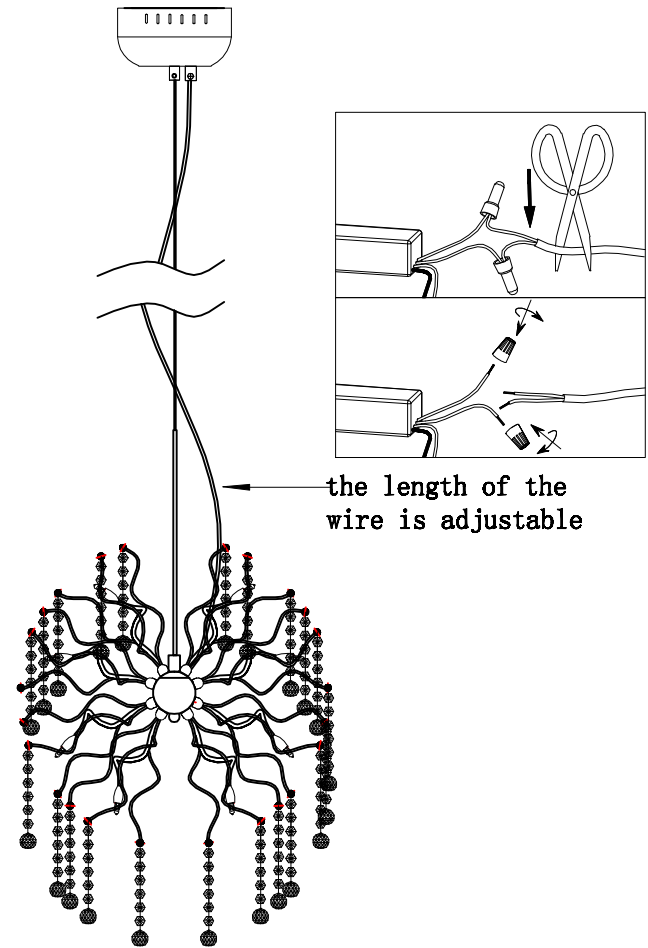

06

2075D18C D18"H134" L6

## Frame Parts List

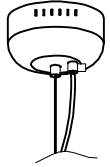

01-Net canopy\*1PC



02-Straight pipe 7.9"\*1PC



03-Cylindrical copper\*1PC



04-G4 bulb 12V Max20W\*6PC

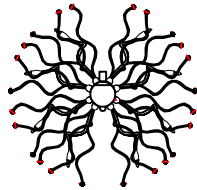

05-ball 18"\*1pcs



03-Crystal string 8.2"\*42PC

2075D18C D18"H134" L6

## CANOPY INSTALLATION INSTRUCTIONS

Please read all instructions carefully. Before you proceed to install, make sure that the power supply is turned off and remains off until installation is complete. Please note that each part has been assigned a letter. Please proceed in alphabetical order.

- ZA. Junction Box (not supplied)
- ZB. Ceiling Plate
- ZC. Box Screws
- ZD. Junction Caps
- ZE. Electric Main
- ZF. Ground Wire
- ZG. Ceiling Screws
- ZH. Nets canopy

1. Attach the Ceiling Plate(B) to the Junction Box(A) using the four Box screws(C) which are not supplied and should already be in your box.
2. Be sure when connecting the wire use electrician approved junction caps(D).
3. Stow the excess wire in the junction box(A).
4. Raise the nets canopy(H).
5. Attach the nets canopy(H) to the ceiling plate(B) using the three ceiling screws(G).